

INDICE

RISCALDAMENTO	5
TERMOSTATI	11
GAS	17
OTTONE FILETTATO	31
FILTRI	41
VALVOLE	45
POLIETILENE-POLIPROPILENE	53
MULTISTRATO	59
ACCESSORI PER RUBINETTERIA	67
SIFONI E PILETTE	91
WC	103
RUBINETTERIA	117
CONSUMO - VARIE	161





OPITEC
riscaldamento

JUNIOR



Scaldacqua elettrico murale ad accumulo

- garanzia 2 anni
- conforme alle nuove direttive Erp
- coibentazione con schiuma di poliuretano espanso ecologico
- caldaia smaltata
- anodo in magnesio

CLASSE ENERGETICA

FINO A



Codice opitec		RIS001	RIS002	RIS003
Installazione		sopra lavello	sopra lavello	sopra lavello
Potenza	W	1200	1200	1500
Voltaggio	V	230	230	230
Capacità	l	10	15	30
Tempo di riscald. ($\Delta T= 45^\circ$)	h, min	0,30	0,45	1,10
Dispersione termica a 65°	kWh/24h	0,43	0,53	0,61
Peso netto	Kg	6,3	7,1	10,5
Dimensioni		a360 b280 c144 d92	a360 b327 c144 d78	a446 b390 c165 d115
Classe energetica	mm	A	A	C
Profilo di prelievo		XXS	XXS	S
Prezzo		€ 174,63	€ 228,36	€ 198,14

sopralavello

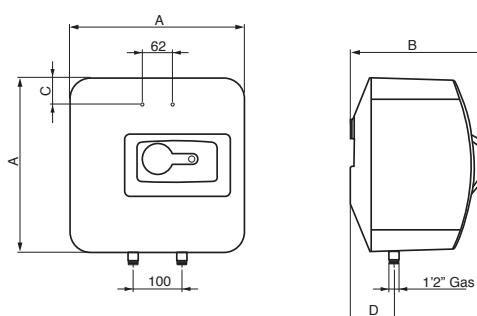

JUNIOR



CLASSE ENERGETICA



Scaldacqua elettrico murale ad accumulo

- garanzia 2 anni
- conforme alle nuove direttive Erp
- coibentazione con schiuma di poliuretano espanso ecologico
- la superficie della caldaia è smaltata a 850° e possiede un elevato spessore
- termometro
- lampada spia
- i processi di produzione hanno tutti la certificazione ISO 9001 e tutti i modelli sono prodotti interamente in Italia

Codice opitec		RIS004	RIS005
Installazione		verticale	verticale
Potenza	W	1200	1200
Voltaggio	V	230	230
Capacità	l	50	80
Tempo di riscald. ($\Delta T = 45^\circ$)	h, min	2,17	3,40
Dispersione termica a 65°	kWh/24h	0,99	0,99
Peso netto	Kg	16	22,1
Dimensioni		a573 e450 f193 h 165 l480	a778 e450 f193 h165 l480
Classe energetica	mm	C	C
Profilo di prelievo		M	M
Prezzo		€ 245,15	€ 251,87

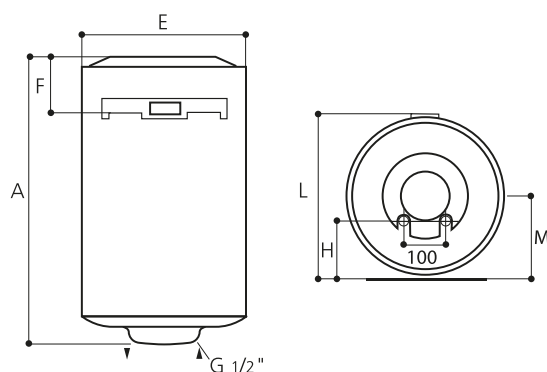



ACCESSORI

	Descrizione	Art.	Ø	Min. Ord.	Prezzo
	Kit per installazione radiatori in alluminio	RIS018	1" x 3/8"	3	€ 11,65
		RIS019	1" x 1/2"	3	€ 11,65

	Descrizione	Art.	Ø	Min. Ord.	Prezzo
	Kit per installazione scaldasalviette	RIS020	1" 1/4 x 3/8"	3	€ 24,18
		RIS021	1" 1/4 x 1/2"	3	€ 23,84

	Descrizione	Art.	Ø	Min. Ord.	Prezzo
	Valvola a squadra termostattizzabile attacco rame/multistrato	RIS022	3/8"	3	€ 23,68
		RIS023	1/2"	3	€ 24,99

	Descrizione	Art.	Ø	Min. Ord.	Prezzo
	Valvola dritta termostattizzabile attacco rame/multistrato	RIS024	1/2"	3	€ 26,56

	Descrizione	Art.	Ø	Min. Ord.	Prezzo
	Testa di comando termostatica per valvola	RIS025	1/2" - 3/8"	3	€ 22,7

ACCESSORI

	Descrizione	Art.	Ø	Min. Ord.	Prezzo
	Detentore a squadra attacco rame/multistrato	RIS026	3/8"	3	€ 12,36
		RIS027	1/2"	3	€ 14,98

	Descrizione	Art.	Ø	Min. Ord.	Prezzo
	Detentore diritto per radiatori attacco tubi rame/multistrato	RIS028	1/2"	3	€ 16,42

	Descrizione	Art.	Ø	Min. Ord.	Prezzo
	Adattatori per multistrato	RIS042	16 mm	3	€ 10,44
		RIS043	20 mm	3	€ 13,57

	Descrizione	Art.	Ø	Min. Ord.	Prezzo
	Adattatori per rame	RIS044	12 mm	3	€ 9,10
		RIS045	14 mm	3	€ 9,40
		RIS046	16 mm	3	€ 8,46

ACCESSORI

	Descrizione	Art.	Ø	Min. Ord.	Prezzo
	Bocchettone in ottone sbiancato conico Raccordo 3 pezzi diritto	RIS029	3/8"	3	€ 6,01
		RIS030	1/2"	3	€ 5,57
		RIS031	3/4"	3	€ 9,57

	Descrizione	Art.	Ø	Min. Ord.	Prezzo
	Bocchettone in ottone sbiancato conico Raccordo 3 pezzi curvo	RIS033	1/2"	3	€ 7,49
		RIS034	3/4"	3	€ 11,85

	Descrizione	Art.	Ø	Min. Ord.	Prezzo
	Valvola sicurezza scaldabagno MF	RIS035	1/2"	3	€ 6,38

	Descrizione	Art.	Ø	Min. Ord.	Prezzo
	Valvola sicurezza scaldabagno tipo pesante MF	RIS036	1/2"	3	€ 5,98

	Descrizione	Art.	Ø	Min. Ord.	Prezzo
	Riduttore di pressione nichelato FF	RIS037	1/2"	3	€ 35,80

ACCESSORI

	Descrizione	Art.	Ø	Min. Ord.	Prezzo
	Coppia rosetta copritubo foro da Ø 10 a 22 mm disponibile in finitura bianca o cromata	RIS038	10 a 22 - bianca	3	€ 2,79
		RIS039	10 a 22 - cromo	3	€ 4,10

	Descrizione	Art.	Min. Ord.	Prezzo
	KIT installazione CALDAIE A GAS composto da:	RIS040 - CALDAIE A GAS	1	€ 67,16

- 1 flessibile estensibile in acciaio inox rivestito per gas con guarnizioni 3/4" M/F - 200-410 mm
- 2 flessibili estensibili in acciaio inox rivestito per acqua M/F 1/2"
- 2 flessibili estensibili in acciaio inox rivestito per acqua M/F 3/4"
- nastro ptf 1/2"x12 mt x 0.075 mm

	Descrizione	Art.	Min. Ord.	Prezzo
	KIT installazione SCALDABAGNI A GAS composto da:	RIS041 - SCALDABAGNI A GAS	1	€ 69,92

- 1 flessibile estensibile in acciaio inox rivestito per gas con guarnizioni 1/2" M/F - 200-410 mm
- 2 flessibili estensibili in acciaio inox rivestito per acqua M/F 1/2"
- 1 rubinetto a squadra per gas M/F 1/2"
- valvola a sfera per acqua M/F 1/2"
- nastro ptf 1/2"x12 mt x 0.075 mm







OPITEC
termostati

CRONO TERMOSTATI

	Descrizione	Art.		Min. Ord.	Prezzo
	Sensibilità di commutazione +/- 0.2°C o +/- 0.3°C Il display mostra la temperatura interna e la temperatura desiderata Regime antigelo	TER001	Termostato digitale C3	1	€ 31,74

	Descrizione	Art.		Min. Ord.	Prezzo
	Programmazione settimanale Programmazione giornaliera 6 temperature programmabili Sensibilità di commutazione +/- 0.2°C o +/- 0.3°C	TER002	Termostato digitale C7	1	€ 42,95

	Descrizione	Art.		Min. Ord.	Prezzo
	Sensibilità di commutazione +/- 0.2°C o +/- 0.3°C Il display mostra la temperatura interna e la temperatura desiderata Regime antigelo	TER003	Termostato digitale C3-RF	1	€ 84,78

	Descrizione	Art.		Min. Ord.	Prezzo
	Programmazione settimanale Programmazione giornaliera 6 temperature programmabili Sensibilità di commutazione +/- 0.2°C o +/- 0.3°C	TER004	Termostato digitale C7-RF	1	€ 87,76

TERMOSTATI

	Descrizione	Art.		Min. Ord.	Prezzo
	Campo di taratura 0-90°C	TER005	Termostato capillare A	1	€ 16,43
	Tolleranza = +/- 5K Tensione di alimentazione 230V Portata max. 10Bar Contatti elettrici C-1 16(4)A - C-2 16(1)A				

	Descrizione	Art.		Min. Ord.	Prezzo
	Campo di taratura 0-90°C	TER006	Termostato in contatto	1	€ 20,17
	Tolleranza = +/- 5K Tensione di alimentazione 230V Portata max. 10Bar	TER007	Termostato ad immersione	1	€ 19,19

CRONO TERMOSTATI

	Descrizione	Art.	Min. Ord.	Prezzo
	<p>Termostato digitale R7</p> <p>Programmazione settimanale</p> <p>Programmazione giornaliera</p> <p>6 temperature programmabili</p> <p>Sensibilità di commutazione +/- 0.5°C</p>	TER008	1	€ 42,95

	Descrizione	Art.	Min. Ord.	Prezzo
	<p>Termostato digitale R3</p> <p>Sensibilità di commutazione +/- 0.5°C</p> <p>Il display mostra la temperatura interna e la temperatura desiderata</p>	TER009	1	€ 40,71

	Descrizione	Art.	Min. Ord.	Prezzo
	<p>Termostato digitale R7-RF</p> <p>Programmazione settimanale</p> <p>Programmazione giornaliera</p> <p>6 temperature programmabili</p> <p>Sensibilità di commutazione +/- 0.5°C</p>	TER010	1	€ 82,91

	Descrizione	Art.	Min. Ord.	Prezzo
	<p>Termostato digitale R3-RF</p> <p>Sensibilità di commutazione +/- 0.5°C</p> <p>Il display mostra la temperatura interna e la temperatura desiderata</p>	TER011	1	€ 80,67









OPITEC

gas

ACCESSORI

	Descrizione	Art.	L mm	Min. Ord.	Prezzo
	Tubo flessibile europeo per Gas Certificato EN 14800 FF 1/2"	GAS001	1000	3	€ 24,75
		GAS002	1500	3	€ 27,30
		GAS003	2000	3	€ 31,80

	Descrizione	Art.	L mm	Min. Ord.	Prezzo
	Tubo flessibile europeo per Gas Certificato EN 14800 MF 1/2"	GAS004	1000	3	€ 24,75
		GAS005	1500	3	€ 27,30
		GAS006	2000	3	€ 31,80

	Descrizione	Art.	L mm	Min. Ord.	Prezzo
	Adattatore per portagomma gas metano e GPL	GAS007	1/2"	5	€ 10,21

ACCESSORI

	Descrizione	Art.	L mm	Min. Ord.	Prezzo
	Flessibile estensibile acciaio inox rivestito giallo per Gas MF	GAS008	1/2" 110-210	3	€ 12,63
		GAS009	1/2" 200-410	3	€ 14,37
		GAS010	3/4" 110-210	3	€ 18,17
		GAS011	3/4" 200-410	3	€ 21,59

	Descrizione	Art.	L mm	Min. Ord.	Prezzo
	Flessibile estensibile per allacciamento contatori gas senza rivestimento 3/4" x 1" MF	GAS012	200-400	5	€ 20,55

	Descrizione	Art.	L mm	Min. Ord.	Prezzo
	Manichetta con leva per Gas Liquido FF 1/2"	GAS013	500	3	€ 8,70
		GAS014	600	3	€ 9,20
		GAS015	800	3	€ 10,24
		GAS016	1000	3	€ 11,15

REGOLATORI E RUBINETTI

	Descrizione	Art.	Min. Ord.	Prezzo
	Regolatore per bombole taratura variabile per esterno	GAS017	3	€ 9,17

	Descrizione	Art.	Min. Ord.	Prezzo
	Regolatore per bombole a squadra taratura variabile per esterno	GAS018	3	€ 11,42

	Descrizione	Art.	Min. Ord.	Prezzo
	Rubinetto ricambio per fornellone a gas GPL	GAS019	3	€ 6,11

TUBI E GOMITI

	Descrizione	Art.		Min. Ord.	Prezzo
	Tubo Gas metano IMQ Ø 13x20 mm mt. 50	GAS080		3	€ 163,31

	Descrizione	Art.		Min. Ord.	Prezzo
	Tubo Gas liquido IMQ Ø 8x13 mm mt. 50	GAS081		3	€ 81,64

	Descrizione	Art.	Ø	Min. Ord.	Prezzo
	Gomito MF in zama	GAS024	1/2"	5	€ 2,96

	Descrizione	Art.	Ø	Min. Ord.	Prezzo
	Gomito MM in zama	GAS025	1/2"	5	€ 2,89

ACCESSORI

	Descrizione	Art.	Ø	Min. Ord.	Prezzo
	Iniettore Gas Con Dado	GAS026	1/4"	5	€ 3,93

	Descrizione	Art.	Ø	Min. Ord.	Prezzo
	Nipples in ottone maschio con filettatura Destra/Sinistra	GAS027	1/2" 20x14	5	€ 4,13

	Descrizione	Art.		Min. Ord.	Prezzo
	Rubinetto campingaz M sinistro con sfiato	GAS028		3	€ 13,00

PORTAGOMMA

	Descrizione	Art.	Ø	Min. Ord.	Prezzo
	Portagomma a 90° F, sede piana	GAS029	1/2"	3	€ 3,59

	Descrizione	Art.		Min. Ord.	Prezzo
	Portagomma Croce a 3 vie Per gas gpl	GAS030		3	€ 3,36

	Descrizione	Art.		Min. Ord.	Prezzo
	Portagomma Croce a 3 vie Per gas metano	GAS031		3	€ 5,64

	Descrizione	Art.		Min. Ord.	Prezzo
	Portagomma Croce a 4 vie Per gas gpl	GAS032		3	€ 4,74

PORTAGOMMA

	Descrizione	Art.		Min. Ord.	Prezzo
	Portagomma a 2 vie Per gpl con attacco bombola sinistra	GAS033		3	€ 9,57

	Descrizione	Art.	Ø	Min. Ord.	Prezzo
	Portagomma con girello per gas liquido	GAS034	1/2"	3	€ 3,12

	Descrizione	Art.		Min. Ord.	Prezzo
	Raccordo diritto connessione gpl	GAS035		3	€ 2,38

	Descrizione	Art.		Min. Ord.	Prezzo
	Riduzione GPL per pipetta maschio M10x1 con oring a norme uni	GAS036	M10x1	3	€ 1,95

PORTAGOMMA

	Descrizione	Art.	Ø	Min. Ord.	Prezzo
	Portagomma per Gas metano femmina	GAS037	3/8"	3	€ 3,22
		GAS038	1/2"	3	€ 5,14
		GAS039	3/4"	3	€ 5,61

	Descrizione	Art.	Ø	Min. Ord.	Prezzo
	Portagomma per Gas metano Maschio	GAS040	3/8"	3	€ 3,22
		GAS041	1/2"	3	€ 4,77
		GAS042	3/4"	3	€ 5,61

	Descrizione	Art.	Ø	Min. Ord.	Prezzo
	Portagomma a squadra per Gas metano Femmina	GAS043	3/8"	3	€ 2,18
		GAS044	1/2"	3	€ 6,35

	Descrizione	Art.	Ø	Min. Ord.	Prezzo
	Portagomma a squadra per Gas metano Maschio	GAS045	1/2"	3	€ 7,29

PORTAGOMMA

	Descrizione	Art.	Ø	Min. Ord.	Prezzo
	Portagomma per Gas GPL Femmina	GAS046	1/4"	3	€ 2,45
		GAS047	3/8"	3	€ 4,40
		GAS048	1/2"	3	€ 3,86

	Descrizione	Art.	Ø	Min. Ord.	Prezzo
	Portagomma per Gas GPL Maschio	GAS049	3/8"	3	€ 2,52
		GAS050	1/2"	3	€ 4,10

	Descrizione	Art.	Ø	Min. Ord.	Prezzo
	Portagomma a squadra per Gas GPL Femmina	GAS051	1/2"	3	€ 3,06

	Descrizione	Art.	Ø	Min. Ord.	Prezzo
	Portagomma a squadra per Gas GPL Maschio	GAS052	1/2"	3	€ 3,69

VALVOLE

	Descrizione	Art.	Ø	Min. Ord.	Prezzo
	Rubinetto a sfera a squadra femmina con portagomma per gas metano	GAS053	1/2"x14	3	€ 14,98

	Descrizione	Art.	Ø	Min. Ord.	Prezzo
	Rubinetto a sfera a squadra maschio con portagomma per gas metano	GAS054	3/8"	3	€ 11,72
		GAS055	1/2"	3	€ 14,64

	Descrizione	Art.	Ø	Min. Ord.	Prezzo
	Rubinetto a sfera MM a squadra	GAS056	1/2"x1/2"	3	€ 12,83

	Descrizione	Art.	Ø	Min. Ord.	Prezzo
	Rubinetto a sfera per Gas, MF, con leva alluminio	GAS057	3/8"	3	€ 9,74
		GAS058	1/2"	3	€ 12,96
		GAS059	3/4"	3	€ 19,48

VALVOLE

	Descrizione	Art.	Ø	Min. Ord.	Prezzo
	Rubinetto a sfera per Gas, FF, con leva alluminio	GAS060	3/8"	3	€ 8,80
		GAS061	1/2"	3	€ 12,56
		GAS062	3/4"	3	€ 17,97

	Descrizione	Art.	Ø	Min. Ord.	Prezzo
	Valvola a sfera per gas a squadra maschio con girello sotto caldaia	GAS063	1/2" x 1/2"	3	€ 15,21
		GAS064	3/4" x 3/4"	3	€ 15,45

	Descrizione	Art.	Ø	Min. Ord.	Prezzo
	Rubinetto a sfera Femmina per GPL con portagomma	GAS065	3/8"	3	€ 12,26
		GAS066	1/2"	3	€ 11,82

	Descrizione	Art.	Ø	Min. Ord.	Prezzo
	Rubinetto a sfera Maschio per GPL con portagomma	GAS067	3/8"	3	€ 12,26
		GAS068	1/2"	3	€ 11,82

	Descrizione	Art.	Ø	Min. Ord.	Prezzo
	Rubinetto a sfera Maschio a squadra per gas GPL	GAS069	1/2"	3	€ 13,27

VALVOLE - ACCESSORI

	Descrizione	Art.	Ø	Min. Ord.	Prezzo
	Rubinetto a sfera Femmina a squadra per gas GPL	GAS070	1/2"	3	€ 13,67

	Descrizione	Art.	Ø	Min. Ord.	Prezzo
	Rubinetto a sfera per Gas metano portagomma diritta Femmina	GAS071	3/8"	3	€ 11,18
		GAS072	1/2"	3	€ 13,94

	Descrizione	Art.	Ø	Min. Ord.	Prezzo
	Rubinetto a sfera per Gas metano portagomma diritta Maschio	GAS073	3/8"	3	€ 11,18
		GAS074	1/2"	3	€ 13,94

	Descrizione	Art.	Ø	Min. Ord.	Prezzo
		GAS075	3/8"	3	€ 8,80
		GAS076	1/2"	3	€ 13,43
		GAS077	3/4"	3	€ 18,84
		GAS078	1"	3	€ 25,29

	Descrizione	Art.	Ø	Min. Ord.	Prezzo
	Chiave universale a croce per armadietti in metallo	GAS079		3	€ 4,27



OPITEC

ottone filettato

ottone filettato

RACCORDERIA

	Descrizione	Art.	Ø	Min. Ord.	Prezzo
	Gomito a 90° FF	OTT001	3/8"	3	€ 4,43
		OTT002	1/2"	3	€ 3,02
		OTT003	3/4"	3	€ 6,04
		OTT004	1"	3	€ 6,21

	Descrizione	Art.	Ø	Min. Ord.	Prezzo
	Gomito a 90° MF	OTT005	3/8"	3	€ 2,79
		OTT006	1/2"	3	€ 3,29
		OTT007	3/4"	3	€ 7,42
		OTT008	1"	3	€ 6,21

	Descrizione	Art.	Ø	Min. Ord.	Prezzo
	Raccordo "T" FFF	OTT009	1/2"	3	€ 3,59
		OTT010	3/4"	3	€ 4,74
		OTT011	1"	3	€ 15,65

	Descrizione	Art.	Ø	Min. Ord.	Prezzo
	Manicotto FF	OTT012	3/8"	3	€ 2,72
		OTT013	1/2"	3	€ 2,55
		OTT014	3/4"	3	€ 3,76
		OTT015	1"	3	€ 6,88

RACCORDERIA

	Descrizione	Art.	Ø	Min. Ord.	Prezzo
	Manicotto FF ridotto	OTT016	1/2"x3/8"	3	€ 2,79
		OTT017	3/4"x1/2"	3	€ 2,62
		OTT018	1"x3/4"	3	€ 6,48

	Descrizione	Art.	Ø	Min. Ord.	Prezzo
	Nipplo doppio MM	OTT019	3/8"	3	€ 1,78
		OTT020	1/2"	3	€ 1,98
		OTT021	3/4"	3	€ 2,28
		OTT022	1"	3	€ 5,84

	Descrizione	Art.	Ø	Min. Ord.	Prezzo
	Nipplo doppio MM ridotto	OTT023	1/2"x3/8"	3	€ 1,48
		OTT024	3/4"x1/2"	3	€ 3,02

	Descrizione	Art.	Ø	Min. Ord.	Prezzo
	Riduzione MF	OTT025	1/2"x3/8"	3	€ 1,71
		OTT026	3/4"x1/2"	3	€ 2,65
		OTT027	1"x3/4"	3	€ 4,13
		OTT028	1"1/4x1"	3	€ 7,32

ottone filettato

RACCORDERIA

	Descrizione	Art.	Ø	Min. Ord.	Prezzo
	Bocchettone diritto FF	OTT029	1/2"	3	€ 9,50
		OTT030	3/4"	3	€ 14,44
		OTT031	1"	3	€ 22,10

	Descrizione	Art.	Ø	Min. Ord.	Prezzo
	Calotta Femmina	OTT032	1/2"	3	€ 1,71
		OTT033	3/4"	3	€ 2,59
		OTT034	1"	3	€ 4,03

	Descrizione	Art.	Ø	Min. Ord.	Prezzo
	Tappo Maschio	OTT035	1/2"	3	€ 1,71
		OTT036	3/4"	3	€ 2,69
		OTT037	1"	3	€ 5,14

	Descrizione	Art.	Ø x L mm	Min. Ord.	Prezzo
	Prolunga Femmina-Maschio	OTT038	1/2"x10	3	€ 1,81
		OTT039	1/2"x15	3	€ 2,12
		OTT040	1/2"x20	3	€ 2,49
		OTT041	1/2"x50	3	€ 5,31
		OTT042	1/2"x80	3	€ 8,03
		OTT043	1/2"x100	3	€ 10,95

RACCORDERIA

	Descrizione	Art.	Ø	Min. Ord.	Prezzo
	Prolunga ridotta	OTT044	3/8"x1/2"	3	€ 2,01
		OTT045	1/2"x3/4"	3	€ 2,49
		OTT046	3/4"x1"	3	€ 5,84

	Descrizione	Art.	Ø x L mm	Min. Ord.	Prezzo
	Barilotto filettato agli estremi	OTT047	1/2"x60	3	€ 4,20
		OTT048	1/2"x100	3	€ 6,99
		OTT049	1/2"x150	3	€ 10,11
		OTT050	1/2"x200	3	€ 13,60
		OTT051	3/4"x60	3	€ 5,27
		OTT052	3/4"x100	3	€ 8,83
		OTT053	3/4"x150	3	€ 13,16
		OTT054	3/4"x200	3	€ 17,43
		OTT055	1"x60	3	€ 7,62
		OTT056	1"x100	3	€ 12,59
		OTT057	1"x150	3	€ 19,24
OTT058	1"x200	3	€ 25,69		

	Descrizione	Art.	Ø x L mm	Min. Ord.	Prezzo
	Barilotto scorrevole maschio	OTT059	1/2"x75	3	€ 5,24
		OTT060	1/2"x100	3	€ 6,85
		OTT061	1/2"x150	3	€ 10,18
		OTT062	1/2"x200	3	€ 12,76
		OTT063	3/4"x200	3	€ 17,19
		OTT064	1"x200	3	€ 24,68

ottone filettato

RACCORDERIA

	Descrizione	Art.	Ø	Min. Ord.	Prezzo
	Filtro a Y	OTT115	1/2"	3	€ 7,35
		OTT116	3/4"	3	€ 11,38

	Descrizione	Art.	Ø	Min. Ord.	Prezzo
	Raccordo ottone 5 vie	OTT117		3	€ 8,28

RACCORDERIA

	Descrizione	Art.	Ø	Min. Ord.	Prezzo
	Gomito a 90° FF Cromato Lucido	OTT065	3/8"	3	€ 2,22
		OTT066	1/2"	3	€ 3,29
		OTT067	3/4"	3	€ 6,99
		OTT068	1"	3	€ 12,09

	Descrizione	Art.	Ø	Min. Ord.	Prezzo
	Gomito a 90° MF Cromato Lucido	OTT069	3/8"	3	€ 3,09
		OTT070	1/2"	3	€ 3,59
		OTT071	3/4"	3	€ 5,07
		OTT072	1"	3	€ 11,92

	Descrizione	Art.	Ø	Min. Ord.	Prezzo
	Raccordo "T" FFF Cromato Lucido	OTT073	3/8"	3	€ 3,09
		OTT074	1/2"	3	€ 4,10
		OTT075	3/4"	3	€ 5,71
		OTT076	1"	3	€ 18,37

	Descrizione	Art.	Ø	Min. Ord.	Prezzo
	Manicotto FF Cromato Lucido	OTT077	3/8"	3	€ 2,49
		OTT078	1/2"	3	€ 2,62
		OTT079	3/4"	3	€ 3,93
		OTT080	1"	3	€ 9,24

ottone filettato

RACCORDERIA

	Descrizione	Art.	Ø x L mm	Min. Ord.	Prezzo
	Prolunga Femmina-Maschio Cromato Lucido	OTT081	1/2"x10	3	€ 1,98
		OTT082	1/2"x15	3	€ 2,22
		OTT083	1/2"x20	3	€ 2,62
		OTT084	1/2"x25	3	€ 3,86
		OTT085	1/2"x30	3	€ 3,69
		OTT086	1/2"x50	3	€ 4,94
		OTT087	1/2"x80	3	€ 7,42
		OTT088	1/2"x100	3	€ 9,91

	Descrizione	Art.	Ø x L mm	Min. Ord.	Prezzo
	Manicotto FF ridotto Cromato Lucido	OTT089	1/2" x 3/8"	3	€ 2,28
		OTT090	3/4" x 1/2"	3	€ 2,69
		OTT091	1" x 3/4"	3	€ 8,73

	Descrizione	Art.	Ø x L mm	Min. Ord.	Prezzo
	Nipplo doppio MM Cromato Lucido	OTT092	3/8" x 3/8"	3	€ 1,31
		OTT093	1/2" x 1/2"	3	€ 1,81
		OTT094	3/4" x 3/4"	3	€ 2,62
		OTT095	1" x 1"	3	€ 6,21

	Descrizione	Art.	Ø	Min. Ord.	Prezzo
	Nipplo doppio MM ridotto Cromato Lucido	OTT096	1/2"x3/8	3	€ 1,65
		OTT097	3/4"x1/2"	3	€ 2,28
		OTT098	1"x3/4"	3	€ 6,95

RACCORDERIA

	Descrizione	Art.	Ø	Min. Ord.	Prezzo
	Riduzione M/F Cromato Lucido	OTT099	1/2" x 3/8"	3	€ 1,28
		OTT101	3/4" x 1/2"	3	€ 1,81

	Descrizione	Art.	Ø	Min. Ord.	Prezzo
	Prolunga/riduzione F/M Cromato Lucido	OTT103	F1/2" x M3/8"	3	€ 1,71
		OTT104	F3/4" x M1/2"	3	€ 2,69
		OTT105	F1" x M3/4"	3	€ 5,94

	Descrizione	Art.	Ø	Min. Ord.	Prezzo
	Calotta Femmina Cromato Lucido	OTT106	3/8"	3	€ 1,18
		OTT107	1/2"	3	€ 1,48
		OTT108	3/4"	3	€ 2,22
		OTT109	1"	3	€ 4,37

	Descrizione	Art.	Ø	Min. Ord.	Prezzo
	Tappo Maschio Cromato Lucido	OTT110	3/8"	3	€ 1,48
		OTT111	1/2"	3	€ 1,65
		OTT112	3/4"	3	€ 2,12
		OTT113	1"	3	€ 5,44

	Descrizione	Art.	Ø	Min. Ord.	Prezzo
	Raccordo a 3 vie cromato lucido	OTT114	1/2"x1/2"x1/2"	3	€ 6,52





OPITEC

filtri

NEUTRALIZZATORI - DEFANGATORI

	Descrizione	Art.	Dimensioni	Min. Ord.	Prezzo
	Filtro condensa caldaie Neutrawater	FIL001	H195xL47 mm att. 3/4" -3/4" (attacco dritto)	1	€ 33,61
		FIL002	H220xL47 mm att. 3/4" -3/4" (attacco a L)	1	€ 33,61

	Descrizione	Art.		Min. Ord.	Prezzo
	Neutra Stick Ricariche per Neutrawater 6 pz	FIL003		1	€ 14,93

FILTRI

	Descrizione	Art.	Ø	Min. Ord.	Prezzo	
FIL004		Defangatore magnetico	FIL004	Defangatore magnetico Compact Duo Ottone	1	€ 78,42
FIL005		Defangatore magnetico	FIL005	Defangatore magnetico Compact Duo Plastica/Ottone	1	€ 59,85
FIL007		Defangatore Magnetico	FIL007	Defangatore magnetico Compact Duo Plastica NEW	1	€50,51

	Descrizione	Prezzo
	Kit salvacaldaia "ECO"	€ 94,10
	Kit salvacaldaia "TOP"	€ 124,30
	Kit salvacaldaia "PREMIUM"	€ 141,10





OPITEC
valvole

CONTATORI



Contatore per acqua fredda

Descrizione	Art.	Ø	Min. Ord.	Prezzo
Contatore per acqua fredda	VAL001	1/2"	3	€ 46,31
	VAL002	3/4"	3	€ 61,12





Contatore per acqua calda

Descrizione	Art.	Ø	Min. Ord.	Prezzo
Contatore per acqua calda	VAL003	1/2"	3	€ 46,31
	VAL004	3/4"	3	€ 62,33

VALVOLE A SFERA

	Descrizione	Art.	Ø	Min. Ord.	Prezzo
	Valvola a sfera per acqua, FF con leva alluminio	VAL005	3/8"	3	€ 6,41
		VAL006	1/2"	3	€ 9,44
		VAL007	3/4"	3	€ 12,56
		VAL008	1"	3	€ 20,79

	Descrizione	Art.	Ø	Min. Ord.	Prezzo
	Valvola a sfera per acqua, MF con leva alluminio	VAL009	3/8"	3	€ 9,20
		VAL010	1/2"	3	€ 9,54
		VAL011	3/4"	3	€ 13,03
		VAL012	1"	3	€ 22,23

	Descrizione	Art.	Ø	Min. Ord.	Prezzo
	Valvola a sfera per acqua, FF con farfalla alluminio	VAL013	3/8"	3	€ 9,24
		VAL014	1/2"	3	€ 9,20
		VAL015	3/4"	3	€ 12,22
		VAL016	1"	3	€ 22,03

	Descrizione	Art.	Ø	Min. Ord.	Prezzo
	Valvola a sfera per acqua, MF con farfalla alluminio	VAL017	3/8"	3	€ 9,20
		VAL018	1/2"	3	€ 9,50
		VAL019	3/4"	3	€ 13,77
		VAL020	1"	3	€ 22,00

VALVOLE A SFERA

	Descrizione	Art.	Ø	Min. Ord.	Prezzo
	Valvola a sfera diritta con bocchettone	VAL021	1/2"	3	€ 11,99
		VAL022	3/4"	3	€ 16,59
		VAL023	1"	3	€ 28,41

	Descrizione	Art.	Ø	Min. Ord.	Prezzo
	Valvola a sfera mini FF	VAL024	3/8"	3	€ 6,78
		VAL025	1/2"	3	€ 7,82

	Descrizione	Art.	Ø	Min. Ord.	Prezzo
	Valvola a sfera mini MF	VAL026	3/8"	3	€ 7,99
		VAL027	1/2"	3	€ 7,89

	Descrizione	Art.	Ø	Min. Ord.	Prezzo
	Valvola a sfera per idrante a pozzetto	VAL028	1/2"	3	€ 19,41

VALVOLE E FILTRI

	Descrizione	Art.	Ø	Min. Ord.	Prezzo
	Valvola d'arresto con cappuccio	VAL029	1/2"	3	€ 29,32

	Descrizione	Art.	Ø	Min. Ord.	Prezzo
	Valvola di ritegno a passaggio totale	VAL030	3/8"	3	€ 10,14
		VAL031	1/2"	3	€ 7,86
		VAL032	3/4"	3	€ 11,89
		VAL033	1"	3	€ 16,19

	Descrizione	Art.	Ø	Min. Ord.	Prezzo
	Filtro per valvola di ritegno	VAL034	1/2"	3	€ 2,32
		VAL035	3/4"	3	€ 2,59
		VAL036	1"	3	€ 2,89

RUBINETTI - ACCESSORI

	Descrizione	Art.	Ø	Min. Ord.	Prezzo
	Rubinetto portagomma a sfera	VAL037	1/2"	3	€ 9,97
		VAL038	3/4"	3	€ 15,58

	Descrizione	Art.	Ø	Min. Ord.	Prezzo
	Rubinetto portagomma a vitone	VAL039	3/8"	3	€ 22,33
		VAL040	1/2"	3	€ 15,35
		VAL041	3/4"	3	€ 36,00

	Descrizione	Art.	Ø	Min. Ord.	Prezzo
	Raccordo femmina attacco rapido	VAL043	1/2"	3	€ 3,93
		VAL044	3/4"	3	€ 4,53

	Descrizione	Art.	Ø	Min. Ord.	Prezzo
	Congiunzione con stringitubo attacco rapido	VAL047	1/2"	3	€ 10,28
		VAL048	3/4"	3	€ 12,69



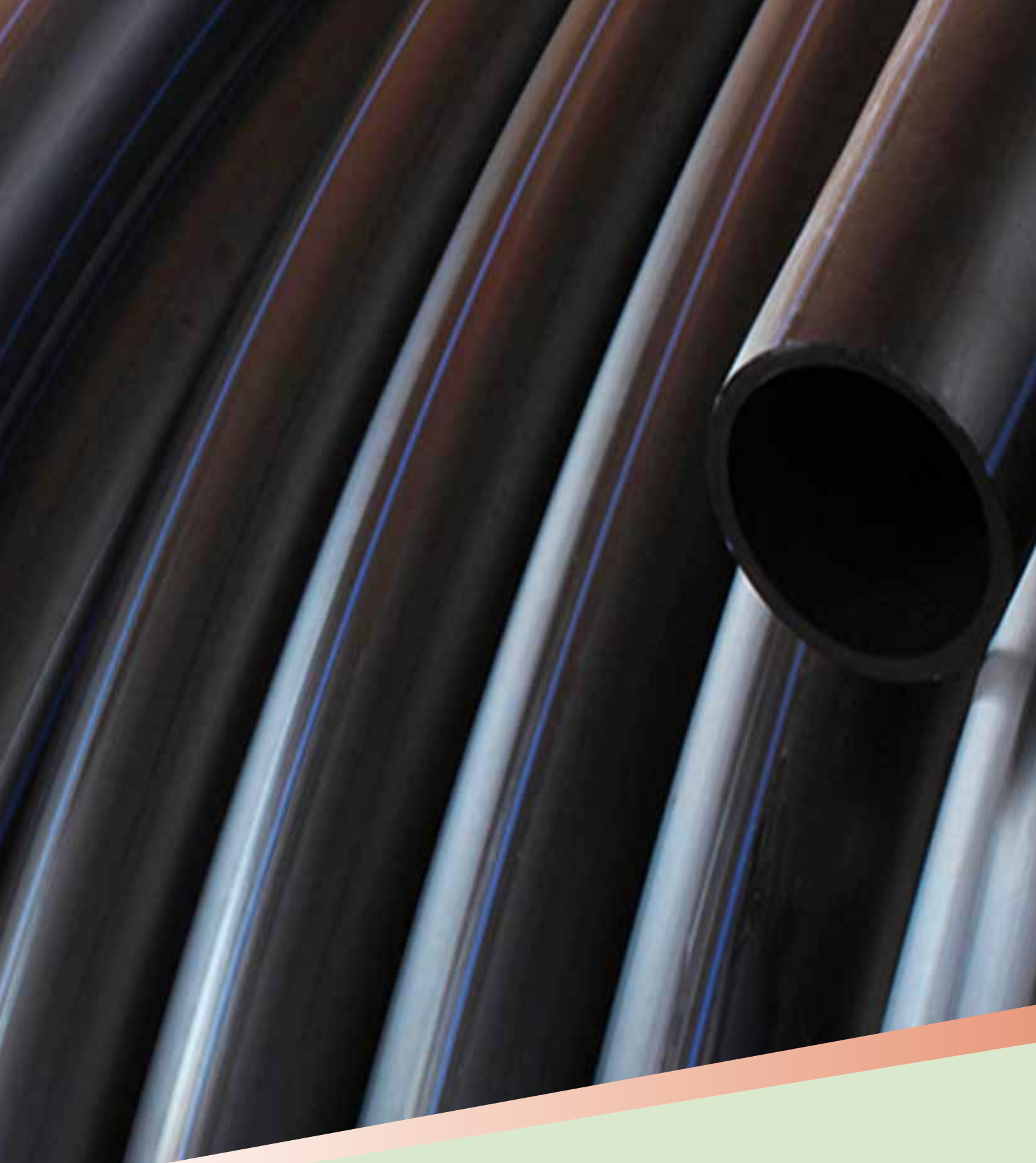



OPITEC

polietilene-polipropilene

polietilene - polipropilene

POLIPROPILENE MARRONE

	Descrizione	Art.	Ø	Min. Ord.	Prezzo
	Gomito a 90° FF in polipropilene marrone	POL063	1/2"	3	€ 1,24
		POL064	3/4"	3	€ 1,54
		POL065	1"	3	€ 2,45

	Descrizione	Art.	Ø	Min. Ord.	Prezzo
	Gomito a 90° MF in polipropilene marrone	POL066	1/2"	3	€ 1,44
		POL067	3/4"	3	€ 1,81
		POL068	1"	3	€ 2,45

	Descrizione	Art.	Ø	Min. Ord.	Prezzo
	Nipples MM in polipropilene marrone	POL069	1/2"	3	€ 0,97
		POL070	3/4"	3	€ 1,07
		POL071	1"	3	€ 1,38

	Descrizione	Art.	Ø	Min. Ord.	Prezzo
	Nipples MM ridotto in polipropilene marrone	POL072	3/4" x 1/2"	3	€ 1,21
		POL073	1" x 3/4"	3	€ 1,61
		POL074	1" 1/4 x 1"	3	€ 2,18

	Descrizione	Art.	Ø	Min. Ord.	Prezzo
	Raccordo "T" FFF in polipropilene marrone	POL075	1/2"	3	€ 1,81
		POL076	3/4"	3	€ 2,28
		POL077	1"	3	€ 3,16

POLIPROPILENE MARRONE

	Descrizione	Art.	Ø	Min. Ord.	Prezzo
	Riduzione MF in polipropilene marrone	POL078	3/4" x 1/2"	3	€ 1,31
		POL079	1" x 1/2"	3	€ 1,68
		POL080	1" x 3/4"	3	€ 1,61
		POL081	1" 1/4 x 1/2"	3	€ 3,69
		POL082	1" 1/4 x 3/4"	3	€ 3,69
		POL083	1" 1/4 x 1"	3	€ 2,89

	Descrizione	Art.	Ø	Min. Ord.	Prezzo
	Manicotto in polipropilene marrone	POL084	1/2"	3	€ 1,21
		POL085	3/4"	3	€ 1,54
		POL086	1"	3	€ 1,81

	Descrizione	Art.	Ø	Min. Ord.	Prezzo
	Bocchettone FF in polipropilene marrone	POL087	1/2"	3	€ 6,48
		POL088	3/4"	3	€ 6,95
		POL089	1"	3	€ 8,29

	Descrizione	Art.	Ø	Min. Ord.	Prezzo
	Tappo M in polipropilene marrone	POL090	1/2"	3	€ 0,97
		POL091	3/4"	3	€ 1,07
		POL092	1"	3	€ 1,44

polietilene - polipropilene

POLIPROPILENE MARRONE



Tappo F
in polipropilene
marrone

Descrizione	Art.	Ø	Min. Ord.	Prezzo
	POL093	1/2"	3	€ 0,97
	POL094	3/4"	3	€ 1,07
	POL095	1"	3	€ 1,61





Barilotto filettato
agli estremi
in polipropilene
marrone

Descrizione	Art.	Ø	Min. Ord.	Prezzo
	POL096	1/2" x 20 cm	3	€ 4,13
	POL097	1/2" x 30 cm	3	€ 4,63
	POL098	1/2" x 50 cm	3	€ 6,55
	POL099	1/2" x 100 cm	3	€ 10,01
	POL100	1/2" x 200 cm	3	€ 15,05
	POL101	3/4" x 20 cm	3	€ 4,63
	POL102	3/4" x 30 cm	3	€ 5,10
	POL103	3/4" x 50 cm	3	€ 7,29
	POL104	3/4" x 100 cm	3	€ 11,05
	POL105	3/4" x 200 cm	3	€ 18,37
	POL106	1" x 20 cm	3	€ 6,99
	POL107	1" x 30 cm	3	€ 7,76
	POL108	1" x 50 cm	3	€ 8,83
	POL109	1" x 100 cm	3	€ 15,45
	POL110	1" x 200 cm	3	€ 25,46

VALVOLE IN POLIETILENE

	Descrizione	Art.	Ø	Min. Ord.	Prezzo
	Rubinetto valvola in polipropilene a sfera PN16	POL111	1/2"	3	€ 16,66
		POL112	3/4"	3	€ 25,69

	Descrizione	Art.	Ø	Min. Ord.	Prezzo
	Valvola a sfera in polipropilene a passaggio totale, estremità filettate, maniglia a leva PN16	POL113	1/2"	3	€ 11,69
		POL114	3/4"	3	€ 13,50

	Descrizione	Art.	Ø	Min. Ord.	Prezzo
	Rubinetto valvola in polipropilene antigelo a sfera, PN16	POL115	1/2"	3	€ 18,94
		POL116	3/4"	3	€ 28,44

	Descrizione	Art.	Ø	Min. Ord.	Prezzo
	Valvola a sfera in polipropilene antigelo a passaggio totale, estremità filettate, maniglia a leva PN16	POL117	1/2"	3	€ 19,85
		POL118	3/4"	3	€ 22,53







OPITEC

multistrato

RACCORDI

	Descrizione	Art.	Ø	Min. Ord.	Prezzo
	Raccordo curvo F a pressare multipinza per multistrato	MTS001	1/2" x 16 mm	3	€ 3,93
		MTS002	1/2" x 20 mm	3	€ 4,70
		MTS003	3/4" x 26 mm	3	€ 9,84

	Descrizione	Art.	Ø	Min. Ord.	Prezzo
	Raccordo curvo M a pressare multipinza per multistrato	MTS004	1/2" x 16 mm	3	€ 3,79
		MTS005	1/2" x 20 mm	3	€ 5,00
		MTS006	3/4" x 26 mm	3	€ 9,87

	Descrizione	Art.	Ø	Min. Ord.	Prezzo
	Raccordo curvo F flangiato a pressare multipinza per multistrato	MTS007	1/2" x 16 mm	3	€ 6,92
		MTS008	1/2" x 20 mm	3	€ 7,59
		MTS009	3/4" x 26 mm	3	€ 15,58

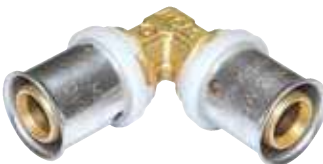
	Descrizione	Art.	Ø	Min. Ord.	Prezzo
	Raccordo curvo Doppio a pressare multipinza per multistrato	MTS010	16 x 16 mm	3	€ 3,66
		MTS011	20 x 20 mm	3	€ 5,34
		MTS012	26" x 26 mm	3	€ 11,82

RACCORDI

	Descrizione	Art.	Ø	Min. Ord.	Prezzo
	Raccordo dritto F a pressare multipinza per multistrato	MTS013	1/2" x 16 mm	3	€ 3,12
		MTS014	1/2" x 20 mm	3	€ 3,69
		MTS015	3/4" x 26 mm	3	€ 7,82

	Descrizione	Art.	Ø	Min. Ord.	Prezzo
	Raccordo dritto M a pressare multipinza per multistrato	MTS016	1/2" x 16 mm	3	€ 3,12
		MTS017	1/2" x 20 mm	3	€ 3,59
		MTS018	3/4" x 26 mm	3	€ 7,82

	Descrizione	Art.	Ø	Min. Ord.	Prezzo
	Raccordo dritto Doppio a pressare multipinza per multistrato	MTS019	16 x 16 mm	3	€ 2,96
		MTS020	20 x 20 mm	3	€ 3,90
		MTS021	26 x 26 mm	3	€ 10,58

	Descrizione	Art.	Ø	Min. Ord.	Prezzo
	Raccordo dritto Ridotto a pressare multipinza per multistrato	MTS023	26 x 20 mm	3	€ 10,58

RACCORDI

	Descrizione	Art.	Ø	Min. Ord.	Prezzo
	Raccordo "T" a pressare multipinza per multistrato	MTS024	16 x 16 x 16 mm	3	€ 4,77
		MTS025	20 x 20 x 20 mm	3	€ 6,85
		MTS026	26 x 26 x 26 mm	3	€ 15,95

	Descrizione	Art.	Ø	Min. Ord.	Prezzo
	Raccordo "T" F a pressare multipinza per multistrato	MTS027	1/2" x 16 mm	3	€ 5,41
		MTS028	1/2" x 20 mm	3	€ 7,05
		MTS029	3/4" x 26 mm	3	€ 14,47

	Descrizione	Art.	Ø	Min. Ord.	Prezzo
	Raccordo "T" M a pressare multipinza per multistrato	MTS030	1/2" x 16 mm	3	€ 10,75
		MTS031	1/2" x 20 mm	3	€ 11,49
		MTS032	3/4" x 26 mm	3	€ 14,47

	Descrizione	Art.	Ø	Min. Ord.	Prezzo
	Raccordo "T" Ridotto a pressare multipinza per multistrato	MTS033	16 x 20 x 16 mm	3	€ 10,38
		MTS035	20 x 16 x 20 mm	3	€ 10,38
		MTS036	20 x 20 x 16 mm	3	€ 10,38
		MTS037	26 x 20 x 26 mm	3	€ 15,92

RACCORDI

	Descrizione	Art.	Ø	Min. Ord.	Prezzo
	Raccordo curvo F a stringere con inserto fisso per multistrato	MTS038	1/2" x 16 mm	3	€ 4,20
		MTS039	1/2" x 20 mm	3	€ 6,04
		MTS040	3/4" x 26 mm	3	€ 12,76

	Descrizione	Art.	Ø	Min. Ord.	Prezzo
	Raccordo curvo M a stringere con inserto fisso per multistrato	MTS041	1/2" x 16 mm	3	€ 4,00
		MTS042	1/2" x 20 mm	3	€ 5,10
		MTS043	3/4" x 26 mm	3	€ 17,63

	Descrizione	Art.	Ø	Min. Ord.	Prezzo
	Raccordo curvo F flangiato a stringere con inserto fisso per multistrato	MTS044	1/2" x 16 mm	3	€ 5,91
		MTS045	1/2" x 20 mm	3	€ 8,23

	Descrizione	Art.	Ø	Min. Ord.	Prezzo
	Raccordo curvo Doppio a stringere con inserto fisso per multistrato	MTS046	16 x 16 mm	3	€ 5,04
		MTS047	20 x 20 mm	3	€ 7,89
		MTS048	26 x 26 mm	3	€ 19,98

RACCORDI

	Descrizione	Art.	Ø	Min. Ord.	Prezzo
	Raccordo dritto F a stringere con inserto fisso per multistrato	MTS049	1/2" x 16 mm	3	€ 3,26
		MTS050	1/2" x 20 mm	3	€ 4,67
		MTS051	3/4" x 26 mm	3	€ 12,09

	Descrizione	Art.	Ø	Min. Ord.	Prezzo
	Raccordo dritto M a stringere con inserto fisso per multistrato	MTS052	1/2" x 16 mm	3	€ 3,06
		MTS053	1/2" x 20 mm	3	€ 4,67
		MTS054	3/4" x 26 mm	3	€ 12,09

	Descrizione	Art.	Ø	Min. Ord.	Prezzo
	Raccordo dritto Doppio a stringere con inserto fisso per multistrato	MTS055	16 x 16 mm	3	€ 4,67
		MTS056	20 x 20 mm	3	€ 7,46
		MTS057	26 x 26 mm	3	€ 20,49

	Descrizione	Art.	Ø	Min. Ord.	Prezzo
	Raccordo dritto ridotto a stringere con inserto fisso per multistrato	MTS058	16 x 20 mm	3	€ 6,04

RACCORDI

	Descrizione	Art.	Ø	Min. Ord.	Prezzo
	Raccordo "T" a stringere con inserto fisso per multistrato	MTS059	16 x 16 x 16 mm	3	€ 6,75
		MTS060	20 x 20 x 20 mm	3	€ 11,02
		MTS061	26 x 26 x 26 mm	3	€ 28,88

	Descrizione	Art.	Ø	Min. Ord.	Prezzo
	Raccordo "T" Ridotto a stringere con inserto fisso per multistrato	MTS062	20 x 20 x 16 mm	3	€ 17,97
		MTS063	20 x 16 x 20 mm	3	€ 16,86

	Descrizione	Art.	Ø	Min. Ord.	Prezzo
	Raccordo "T" F a stringere con inserto fisso per multistrato	MTS065	1/2" x 16 mm	3	€ 6,04
		MTS066	1/2" x 20 mm	3	€ 8,36
		MTS067	3/4" x 26 mm	3	€ 24,18

	Descrizione	Art.	Ø	Min. Ord.	Prezzo
	Raccordo "T" M a stringere con inserto fisso per multistrato	MTS068	1/2" x 16 mm	3	€ 5,81
		MTS069	1/2" x 20 mm	3	€ 8,13
		MTS070	3/4" x 26 mm	3	€ 27,71







OPITEC

accessori rubinetteria

accessori rubinetteria

RUBINETTI

	Descrizione	Art.	Ø	Min. Ord.	Prezzo
	Rubinetto a snodo	ACR001	1/2"	3	€ 35,50

	Descrizione	Art.	Ø	Min. Ord.	Prezzo
	Rubinetto sottolavabo più filtro, più snodo 1/2" - 3/8", più rosetta e dado alto	ACR002	1/2"x3/8"	3	€ 14,64

	Descrizione	Art.	Ø	Min. Ord.	Prezzo
	Rubinetto cromato sottolavabo 1/2" - 3/8" - 3/4" dado conico alto	ACR003	1/2"x3/8"x3/4"	3	€ 27,07

	Descrizione	Art.	Ø	Min. Ord.	Prezzo
	Rubinetto sottolavabo brevettato con filtro	ACR004	1/2"x3/8"	3	€ 8,09

RUBINETTI

	Descrizione	Art.	Ø	Min. Ord.	Prezzo
	Rubinetto a sfera sottolavabo - Eco -	ACR097	1/2"	3	€ 5,38

	Descrizione	Art.	Ø	Min. Ord.	Prezzo
	Rubinetto di scarico	ACR098	1/2"	3	€ 5,38

	Descrizione	Art.	Ø	Min. Ord.	Prezzo
	Rubinetto a sfera sotto lavabo tondo	ACR099	1/2"-3/8"	3	€ 8,28
		ACR100	1/2"-1/2"	3	€ 8,28

RACCORDI

	Descrizione	Art.	Ø	Min. Ord.	Prezzo
	Attacco cromato sottolavabo regolabile	ACR005	1/2" x 3/8"	3	€ 9,27

	Descrizione	Art.	Ø	Min. Ord.	Prezzo
	Squadretta in rame cromato, completa di nipplo e raccordo a compressione con cartuccia a 3 pezzi	ACR006	M1/2" x F1/2"	3	€ 20,59

	Descrizione	Art.	Ø mm	Min. Ord.	Prezzo
	Tubetto con flangia ricavata e dado	ACR007	1/2" x 400	3	€ 8,03

	Descrizione	Art.	Ø - L mm	Min. Ord.	Prezzo
	Tubetto di rame ricotto e cromato dritto e senza flangiatura	ACR008	Ø 10 x 1000	3	€ 15,01
		ACR009	Ø 12 x 1000	3	€ 20,79
		ACR010	Ø 14 x 1000	3	€ 22,70

RACCORDI

	Descrizione	Art.	Ø	Min. Ord.	Prezzo
	Raccordo a gomito con guarnizioni in gomma, ranelle e anelli tagliati in ottone	ACR011	3/8"x10	3	€ 10,04

	Descrizione	Art.	Ø - Ø mm	Min. Ord.	Prezzo
	Prolunga ottone cromato con guarnizioni in gomma, ranelle e anelli tagliati in ottone	ACR012	F 3/8" x RCC 3/8"	3	€ 5,91

	Descrizione	Art.	Ø	Min. Ord.	Prezzo
	Doppio nipples completo con guarnizioni in 3 pezzi e ranelle e anelli tagliati in ottone	ACR013	3/8"x10x10	3	€ 6,65

RACCORDI

	Descrizione	Art.	Ø x Ø x Ø mm	Min. Ord.	Prezzo
	Nipples completo con guarnizione in gomma ranella e anello tagliato in ottone M1/2" x 3/8"	ACR014	M1/2" x 3/8" x 10	3	€ 5,44
		ACR015	M1/2" x 3/8" x 12	3	€ 8,09

	Descrizione	Art.	Ø	Min. Ord.	Prezzo
	Raccordo a T con guarnizioni in gomma, ranelle e anelli tagliati in ottone	ACR016	10x10x10	3	€ 10,85

	Descrizione	Art.	Ø	Min. Ord.	Prezzo
	Gomito MM con una calotta conica guarnizione conica in gomma, rondella, spaccata, in ottone cromato	ACR017	3/8" x 10	3	€ 9,20

AERATORI

	Descrizione	Art.	Ø	Min. Ord.	Prezzo
	Aeroflux vasca in ottone	ACR018	M 28	3	€ 2,79

	Descrizione	Art.	Ø	Min. Ord.	Prezzo
	Aeroflux ottone cromato Femmina pz. 10	ACR019	M 22x1	3	€ 12,49

	Descrizione	Art.	Ø	Min. Ord.	Prezzo
	Cartuccia ricambio per aeratore Femmina pz. 2	ACR020	M 22x1	3	€ 2,12

accessori rubinetteria

AERATORI E ROMPIGETTO



	Descrizione	Art.	Ø	Min. Ord.	Prezzo
	Aeroflux ottone cromato Maschio pz. 10	ACR021	M 24x1	3	€ 12,49



	Descrizione	Art.	Ø	Min. Ord.	Prezzo
	Cartuccia ricambio kit con 10 pezzi	ACR023	M 24x1	3	€ 8,83



	Descrizione	Art.	Ø	Min. Ord.	Prezzo
	Rompigetto per bidet con snodo Maschio	ACR024	M 24	3	€ 6,21



	Descrizione	Art.	Ø	Min. Ord.	Prezzo
	Rompigetto per bidet con snodo Femmina	ACR025	M 24	3	€ 6,21

AERATORI

	Descrizione	Art.	Ø - Lt/min	Min. Ord.	Prezzo
 	Aeroflux ottone 22/24 F con limitatore	ACR101	F 22/24 - 6	3	€ 2,75
		ACR102	F 22/24 - 8	3	€ 2,82



	Descrizione	Art.	Lt/min	Min. Ord.	Prezzo
 	Cartuccia di ricambio per aeroflux ottone F con limitatore	ACR103	6	3	€ 3,16
		ACR104	8	3	€ 3,06



	Descrizione	Art.	Ø - Lt/min	Min. Ord.	Prezzo
 	Aeroflux ottone 22/24 M con limitatore	ACR105	M 22/24 - 6	3	€ 2,82
		ACR106	M 22/24 - 8	3	€ 2,72



	Descrizione	Art.	Lt/min	Min. Ord.	Prezzo
 	Cartuccia di ricambio per aeroflux ottone M con limitatore	ACR107	6	3	€ 3,09
		ACR108	8	3	€ 3,26



accessori rubinetteria

AERATORI



	Descrizione	Art.	Ø - Lt/min	Min. Ord.	Prezzo
 	Aeroflux ottone 22/24 F con economizzatore	ACR109	F 22/24 - 6	3	€ 2,18
		ACR110	F 22/24 - 8	3	€ 2,18



	Descrizione	Art.	Lt/min	Min. Ord.	Prezzo
 	Cartuccia di ricambio per aeroflux F con economizzatore	ACR111	6	3	€ 2,28
		ACR112	8	3	€ 2,28

	Descrizione	Art.	Ø - Lt/min	Min. Ord.	Prezzo
 	Aeroflux ottone 22/24 M con economizzatore	ACR113	M 22/24 - 6	3	€ 2,01
		ACR114	M 22/24 - 8	3	€ 2,01

	Descrizione	Art.	Lt/min	Min. Ord.	Prezzo
 	Cartuccia di ricambio per aeroflux M con economizzatore	ACR115	6	3	€ 2,25
		ACR116	8	3	€ 2,28

ROMPIGETTO

	Descrizione	Art.	Ø - Lt/min	Min. Ord.	Prezzo
 	Rompigetto per bidet 22 F con snodo e con economizzatore	ACR117	F 22 - 6	3	€ 6,18
		ACR118	F 22 - 8	3	€ 6,08

	Descrizione	Art.	Ø - Lt/min	Min. Ord.	Prezzo
 	Rompigetto per bidet 24 M con snodo e con economizzatore	ACR119	M 24 - 6	3	€ 6,08
		ACR120	M 24 - 8	3	€ 6,08

accessori rubinetteria

ROMPIGETTO

	Descrizione	Art.	Ø	Min. Ord.	Prezzo
	Riduttore MM per rompigitto in ottone M22 x M24	ACR026	M22 x M24	3	€ 3,19

	Descrizione	Art.	Ø	Min. Ord.	Prezzo
	Rompigitto pk con aeratore doccia	ACR027	M 22/24	3	€ 4,94

	Descrizione	Art.	Ø	Min. Ord.	Prezzo
	Rompigitto pk con aeratore a doccia manico in gomma	ACR028	M 22/24	3	€ 4,10

	Descrizione	Art.	Ø	Min. Ord.	Prezzo
	Aeratore per cucina Commutabile tra getto aerato e getto spray a snodo	ACR029	M22 x 1 F M24 x 1 M	3	€ 3,46





AERATORI

	Descrizione	Art.	Ø	Min. Ord.	Prezzo
	BUBBLE-STREAM® Aeratore per cucina; Commutabile tra getto aerato e getto spray anello di colore arancio con giunto sferico in plastica girevole	ACR122	M22 x 1F M24 x 1M	3	€ 4,94

	Descrizione	Art.	Ø	Min. Ord.	Prezzo
	BUBBLE-STREAM® Aeratore per cucina; Commutabile tra getto aerato e getto spray anello di colore verde con giunto sferico in plastica girevole	ACR123	M22 x 1F M24 x 1M	3	€ 4,94

	Descrizione	Art.	Ø	Min. Ord.	Prezzo
	BUBBLE-STREAM® Aeratore per cucina; Commutabile tra getto aerato e getto spray anello di colore viola con giunto sferico in plastica girevole	ACR124	M22 x 1F M24 x 1M	3	€ 4,94

ROMPIGETTO

	Descrizione	Art.	Ø	Min. Ord.	Prezzo
	Rompigetto doccia/tubo flessibile doppia spirale in acciaio cromato/bianco raccordo e ghiera in ottone cromato, finitura cromo/bianco con economizzatore	ACR125	22 x 1 F	3	€ 19,91
	Rompigetto doccia/tubo flessibile doppia spirale in acciaio cromato/nero raccordo e ghiera in ottone cromato, finitura cromo/nero con economizzatore	ACR126	22 x 1 F	3	€ 19,91
	Rompigetto doccia/tubo flessibile doppia spirale in acciaio cromato raccordo e ghiera in ottone cromato, finitura cromato con economizzatore	ACR127	22 x 1 F	3	€ 19,91
	Flessibile a spirale in acciaio cromato/bianco, lunghezza 15 cm, raccordo e ghiera in ottone cromato, finitura cromo/bianco	ACR128	22 x 1 F	3	€ 17,13
	Flessibile a spirale in acciaio cromato/nero, lunghezza 15 cm, raccordo e ghiera in ottone cromato, finitura cromo/nero	ACR129	22 x 1 F	3	€ 17,13

ACCESSORI

	Descrizione	Art.	Ø mm	Min. Ord.	Prezzo
	Tappo con catena e placca inox	ACR030	31	3	€ 2,85
		ACR031	40	3	€ 3,02
		ACR032	47	3	€ 3,46
		ACR033	52	3	€ 3,12

	Descrizione	Art.	Ø mm	Min. Ord.	Prezzo
	Griglia bianca pz. 2	ACR034	85	3	€ 1,18

	Descrizione	Art.	Ø mm	Min. Ord.	Prezzo
	Sturalavandino altezza 42 cm ventosa rossa Ø 135 mm e manico in legno	ACR035	135	3	€ 17,33

	Descrizione	Art.	Ø	Min. Ord.	Prezzo
	Guarnizioni gomma per carico lavatrice 10 pz.	ACR036	3/4"	3	€ 0,97

accessori rubinetteria

RACCORDI IN PLASTICA

	Descrizione	Art.	Ø	Min. Ord.	Prezzo
	Giunzione per scarico e carico lavatrice	ACR037	3/4"	3	€ 1,18

	Descrizione	Art.	Ø	Min. Ord.	Prezzo
	Presa Y carico	ACR038	3/4"	3	€ 2,79

	Descrizione	Art.	Ø	Min. Ord.	Prezzo
	Giunzione a Y per scarico lavatrice	ACR039		3	€ 1,31

	Descrizione	Art.	Ø	Min. Ord.	Prezzo
	Raccordo a pipa per carico lavatrice	ACR040		3	€ 2,96

TUBI

	Descrizione	Art.	L mm	Min. Ord.	Prezzo
	Tubo scarico lavatrice spiraflex	ACR041	1500	3	€ 3,79
		ACR042	2000	3	€ 4,16
		ACR043	2500	3	€ 4,53

	Descrizione	Art.	L mm	Min. Ord.	Prezzo
	Tubo carico lavatrice FF	ACR044	1500	3	€ 4,90
		ACR045	2000	3	€ 6,45
		ACR046	2500	3	€ 5,54

accessori rubinetteria

RUBINETTI LAVATRICE

	Descrizione	Art.	Ø	Min. Ord.	Prezzo
	Rubinetto per lavatrice a sfera cromato	ACR047	1/2"	3	€ 12,39

	Descrizione	Art.	Ø	Min. Ord.	Prezzo
	Rubinetto a 3 vie sottolavabo	ACR048	1/2"x1/2"x3/4"	3	€ 12,73
		ACR049	3/8"x1/2"x3/4"	3	€ 12,73

	Descrizione	Art.	Ø	Min. Ord.	Prezzo
	Rubinetto inclinato con attacco lavatrice	ACR050	1/2"	3	€ 12,86

	Descrizione	Art.	Ø x Ø x Ø mm	Min. Ord.	Prezzo
	Rubinetto per lavatrice a sfera cromato BiBo	ACR051	3/8"	3	€ 14,17
		ACR052	1/2"	3	€ 13,94

RUBINETTI LAVATRICE

	Descrizione	Art.	Ø	Min. Ord.	Prezzo
	Rubinetto a snodo con attacco lavatrice	ACR053	1/2"	3	€ 46,55

	Descrizione	Art.	Ø	Min. Ord.	Prezzo
	Portagomma con dado in ottone cromato 1"	ACR054	22	3	€ 4,74

SCATOLE ACCESSORI

	Descrizione	Art.	Min. Ord.	Prezzo
	Scatola con 480 anelli "OR" Per vitoni del tipo originale rettificato, assortiti in 12 misure da ø esterno 8 mm al ø esterno 20,5 mm	ACR055	3	€ 24,28

	Descrizione	Art.	Min. Ord.	Prezzo
	Scatola contenente guarnizioni miste per uso idraulico 400 pcs	ACR056	1	€ 48,19

TUBI FLESSIBILI

	Descrizione	Art.	Ø mm	Min. Ord.	Prezzo
	Flessibile per acqua in acciaio estensibile MF AISI 316	ACR057	110-210 1/2" MF	3	€ 9,77
		ACR058	110-210 3/4" MF	3	€ 13,13
		ACR059	200-410 1/2" MF	3	€ 11,99
		ACR060	200-410 3/4" MF	3	€ 16,42

TUBI FLESSIBILI IN SILICONE

Il silicone platinico, materiale pregiato di altissima qualità, sta raccogliendo sempre più consenso grazie alla sua purezza ed alla capacità di mantenere inalterate le caratteristiche igieniche dell'acqua potabile ottenendo riscontri positivi presso molti Istituti di Certificazione in tutto il mondo. Rispetto ad altre tipologie di silicone disponibile sul mercato, il silicone platinico è in assoluto il più puro e capace di garantire la piena alimentarietà secondo la norma DM. n. 174 del 6 Aprile 2004. Inoltre non contiene componenti tossici. Infine ha notevoli capacità di mantenimento di buoni livelli di elasticità e ottime proprietà meccaniche in tutto il range di temperatura di servizio.

APPLICAZIONI

Rubinetti tradizionali
 Rubinetti miscelatori
 Cassette scarico - Caldaie
 Caldaie/scaldabagni - Installazioni generiche



	Descrizione	Art.	L mm Ø	Min. Ord.	Prezzo
	Attacchino flessibile inox AISI 304 DN 8 interno in silicone maschio corto 10x1-femmina (con guarnizione inserita)	ACR061	250 3/8	3	€ 5,37
		ACR062	300 3/8	3	€ 5,68
		ACR063	350 3/8	3	€ 7,59
		ACR064	400 3/8	3	€ 6,35
		ACR065	500 3/8	3	€ 6,99
		ACR066	600 3/8	3	€ 7,59
		ACR067	250 1/2	3	€ 5,68
		ACR068	300 1/2	3	€ 5,98
		ACR069	350 1/2	3	€ 6,31
		ACR070	400 1/2	3	€ 6,62
		ACR071	500 1/2	3	€ 7,25
		ACR072	600 1/2	3	€ 7,86

TUBI FLESSIBILI IN SILICONE

	Descrizione	Art.	L mm Ø	Min. Ord.	Prezzo
		ACR073	250 M3/8 - F3/8	3	€ 5,98
		ACR074	300 M3/8 - F3/8	3	€ 6,31
		ACR075	350 M3/8 - F3/8	3	€ 8,70
		ACR076	400 M3/8 - F3/8	3	€ 6,92
		ACR077	500 M3/8 - F3/8	3	€ 7,52
		ACR078	600 M3/8 - F3/8	3	€ 8,13
		ACR079	250 M3/8 - F1/2	3	€ 6,25
		ACR080	300 M3/8 - F1/2	3	€ 6,62
		ACR081	350 M3/8 - F1/2	3	€ 9,10
		ACR082	400 M3/8 - F1/2	3	€ 7,25
		ACR083	500 M3/8 - F1/2	3	€ 7,25
		ACR084	600 M3/8 - F1/2	3	€ 7,93
		ACR085	250 M1/2 - F3/8	3	€ 6,04
		ACR086	300 M1/2 - F3/8	3	€ 6,25
		ACR087	350 M1/2 - F3/8	3	€ 9,10
		ACR088	400 M1/2 - F3/8	3	€ 6,85
		ACR089	500 M1/2 - F3/8	3	€ 6,88
		ACR090	600 M1/2 - F3/8	3	€ 7,52
		ACR091	250 M1/2 - F1/2	3	€ 6,31
		ACR092	300 M1/2 - F1/2	3	€ 6,72
		ACR093	350 M1/2 - F1/2	3	€ 9,54
		ACR094	400 M1/2 - F1/2	3	€ 7,29
		ACR095	500 M1/2 - F1/2	3	€ 7,96
		ACR096	600 M1/2 - F1/2	3	€ 8,63



Attacchino flessibile
inox AISI 304 DN 8
interno in silicone
maschio corto
10x1-femmina
(con guarnizione inserita)









OPITEC

sifoni e pilette

sifoni e pilette

SIFONI IN METALLO







	Descrizione	Art.	Ø	Min. Ord.	Prezzo
	Sifone a bottiglia in metallo senza piletta	SIF001	1"	1	€ 22,06
		SIF002	1" 1/4	1	€ 21,33

	Descrizione	Art.	Ø	Min. Ord.	Prezzo
	Sifone "S" in metallo senza piletta	SIF003	1"	1	€ 23,21
		SIF004	1" 1/4	1	€ 26,26

	Descrizione	Art.	Ø	Min. Ord.	Prezzo
	Sifone quadrato	SIF054	1"	1	€ 30,22

	Descrizione	Art.	Ø	Min. Ord.	Prezzo
	Sifone tondo	SIF055	1"	1	€ 30,22

PILETTE E SCARICHI

	Descrizione	Art.	Ø	Min. Ord.	Prezzo
	Piletta in ottone per sifoni	SIF005	1"	3	€ 16,32
		SIF006	1" 1/4	3	€ 17,97
	Descrizione	Art.	Ø	Min. Ord.	Prezzo
	Pilette sifoide con troppo pieno in ottone cromato con tappo a maniglia	SIF007	80	3	€ 48,80
	Descrizione	Art.	Ø	Min. Ord.	Prezzo
	Scarico tondo con click-clack senza troppo pieno per lavabo e bidet	SIF008	1" 1/4	3	€ 25,96
	Descrizione	Art.	Ø	Min. Ord.	Prezzo
	Piletta click clack per bidet/lavabo molla inox parti cromate con troppo pieno	SIF056	1" 1/4	3	€ 18,47
	Descrizione	Art.	Ø	Min. Ord.	Prezzo
	Piletta automatica in ottone cromato per lavabo/bidet con meccanismo apertura estraibile. Ideale per lavabi di diversi spessori, chiusura e apertura con un click	SIF009	1" 1/4	3	€ 23,31
	Descrizione	Art.	Ø	Min. Ord.	Prezzo
	Piletta ribassata per piatto doccia	SIF057	foro 90 mm coperchio 120 mm	3	€ 24,58
	Descrizione	Art.	Ø	Min. Ord.	Prezzo
	Piletta ribassata per piatto doccia sifoide con coperchio quadrato abs	SIF058	foro 90 mm coperchio 120 mm	3	€ 36,57

sifoni e pilette

RACCORDI IN OTTONE

	Descrizione	Art.	Ø	Min. Ord.	Prezzo
	Raccordo per passaggio da piombo a plastica in ottone cromato	SIF010	26	3	€ 6,04
		SIF011	30	3	€ 6,21
		SIF012	32	3	€ 6,21

	Descrizione	Art.	Ø	Min. Ord.	Prezzo
	Raccordo di congiunzione universale in ottone cromato	SIF013	26/26	3	€ 6,01
		SIF014	30/30	3	€ 6,78
		SIF015	32/32	3	€ 6,72
		SIF016	40/40	3	€ 7,56

	Descrizione	Art.	Ø	Min. Ord.	Prezzo
	Raccordo di congiunzione ridotto universale in ottone cromato	SIF017	32/26	1	€ 7,42
		SIF018	40/32	1	€ 9,20

	Descrizione	Art.	Ø	Min. Ord.	Prezzo
	Raccordo passaggio ridotto da piombo a plastica in ottone giallo	SIF019	32/26	1	€ 9,71
		SIF020	40/32	1	€ 10,18

SIFONI IN PLASTICA

	Descrizione	Art.	Ø mm x Ø	Min. Ord.	Prezzo
	Sifone curvo Geberit per lavabo, scarico orizzontale	SIF021	40 x 1"1/4	1	€ 24,72

	Descrizione	Art.	Ø	Min. Ord.	Prezzo
	Sifone minimal in abs bianco	SIF022	1"1/4	1	€ 11,75

	Descrizione	Art.	Ø x L mm	Min. Ord.	Prezzo
	Canotto in abs cromato	SIF023	26 x 250	1	€ 4,03
		SIF024	32 x 300	1	€ 4,90

	Descrizione	Art.	Ø x L mm	Min. Ord.	Prezzo
	Canotto in abs cromato con cartella	SIF025	26 x 250	1	€ 3,83
		SIF026	32 x 300	1	€ 4,90

sifoni e pilette

SIFONI IN PLASTICA

	Descrizione	Art.	Ø	Min. Ord.	Prezzo
--	-------------	------	---	-----------	--------



Sifone lavello "space 1"
autopulente a 1 via

SIF027

1" 1/2

1

€ 9,17

	Descrizione	Art.	Ø	Min. Ord.	Prezzo
--	-------------	------	---	-----------	--------



Sifone lavello "space 2"
autopulente a 2 vie

SIF028

1" 1/2

1

€ 15,05

	Descrizione	Art.	Ø	Min. Ord.	Prezzo
--	-------------	------	---	-----------	--------



Sifone moplen
2 vie senza piletta

SIF029

1" 1/4

1

€ 7,72

SIFONI IN PLASTICA

	Descrizione	Art.	Ø	Min. Ord.	Prezzo
	Sifone in plastica 1 via senza piletta	SIF030	1" 1/2	1	€ 4,87

	Descrizione	Art.	Ø	Min. Ord.	Prezzo
	Sifone in plastica 2 vie senza piletta	SIF031	1" 1/2	1	€ 7,05

	Descrizione	Art.	Ø mm	Min. Ord.	Prezzo
	Sifone per piatti doccia con foro con coperchio ABS cromato	SIF032	foro 90 - cop. 120	3	€ 21,33
		SIF033	foro 60 - cop. 80	3	€ 11,08

sifoni e pilette

RACCORDI IN PLASTICA

	Descrizione	Art.	Ø mm	Min. Ord.	Prezzo
	Curva filettata con ghiera e guarnizione	SIF034	1"1/4 - Ø 32x210	1	€ 5,37
		SIF035	1"1/2 - Ø 40x240	1	€ 5,68

	Descrizione	Art.	Ø	Min. Ord.	Prezzo
	Attacco lavatrice sottopiletta 1"1/2 con deflettore antiriflusso	SIF036	1"1/2 x 1"1/2	3	€ 8,77

	Descrizione	Art.	Ø mm	Min. Ord.	Prezzo
	Attacco lavatrice su tubo flangiato con deflettore antiriflusso	SIF037	1"1/2 x Ø 40x200	3	€ 7,02

	Descrizione	Art.	Ø mm	Min. Ord.	Prezzo
	Canotto flessibile ed estensibile attacco con ghiera girevole in metallo cromato	SIF038	1" x Ø 32	1	€ 2,18
		SIF039	1"1/4 x Ø 32	1	€ 2,18
		SIF040	1"1/2 x Ø 40	1	€ 2,18

RACCORDI IN PLASTICA

	Descrizione	Art.	Ø mm	Min. Ord.	Prezzo
	Prolungha universale completa di ghiera e guarnizione	SIF041	1"1/4 x 32x165	3	€ 3,63
		SIF042	1"1/2 x 40x230	3	€ 4,74

	Descrizione	Art.	Ø mm	Min. Ord.	Prezzo
	Attacco lavatrice universale con deflettore antiriflusso completo di ghiera e guarnizione	SIF043	1"1/2 x 40	3	€ 2,96

	Descrizione	Art.	Ø mm	Min. Ord.	Prezzo
	Canotto eccentrico per collegamento dei tubi di cacciata al vaso w.c.	SIF044	32	3	€ 8,50

	Descrizione	Art.	Ø mm	Min. Ord.	Prezzo
	Canotto diritto polipropilene PP bianco	SIF045	40	3	€ 1,58

sifoni e pilette

ACCESSORI

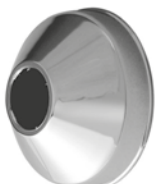
	Descrizione	Art.	Ø mm	Min. Ord.	Prezzo
	Rosone "maxi" per canotti eccentrici ABS cromato	SIF046	32 - 100	3	€ 6,18

	Descrizione	Art.	Ø mm	Min. Ord.	Prezzo
	Rosone polipropilene PP bianco	SIF047	40 - 100	3	€ 1,14

	Descrizione	Art.	Ø	Min. Ord.	Prezzo
	Piletta per lavelli in ceramica	SIF048	1"1/2	3	€ 4,10

	Descrizione	Art.	Ø	Min. Ord.	Prezzo
	Piletta con troppo pieno per lavelli in acciaio inox	SIF049	1"1/2	1	€ 5,94

ACCESSORI

	Descrizione	Art.	Ø	Min. Ord.	Prezzo
	Piletta senza troppopieno per lavelli in acciaio inox	SIF050	1" 1/2	3	€ 4,27

	Descrizione	Art.	Ø	Min. Ord.	Prezzo
	Piletta Basket universale con uscita per troppopieno e tappo di chiusura. (da completare con kit troppopieno)	SIF051	3/4"	3	€ 6,95

	Descrizione	Art.		Min. Ord.	Prezzo
	Kit troppopieno universale per fori rettangolari e tondi	SIF052		3	€ 6,88

	Descrizione	Art.	Ø mm	Min. Ord.	Prezzo
	Cestello tappo inox per piletta basket da 3" 1/2"	SIF053	3" 1/2 Ø 80	3	€ 4,10







OPITEC

WC

KIT COMBIFIX **GEBERIT**

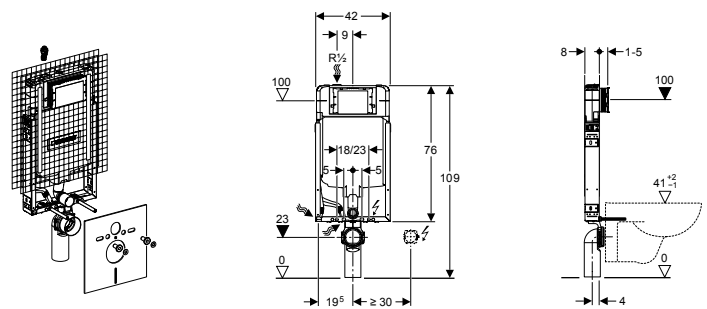
COMBIFIX SIGMA8	Descrizione	Art.	Min. Ord.	Prezzo
	Combifix Italia Sigma8 8 cm di spessore, per WC sospesi	WCC001	1	€ 611,58



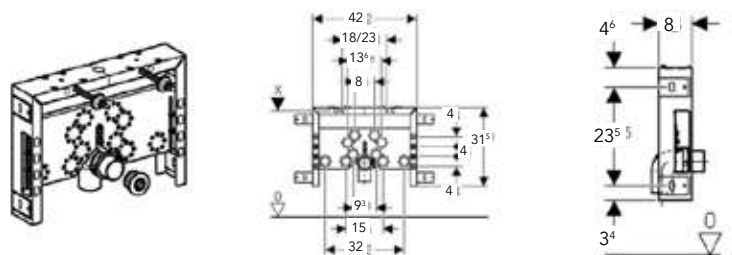

COMBIFIX	Descrizione	Art.	Min. Ord.	Prezzo
	Kit Combifix Italia Per Bidet	WCC002	1	€ 359,67

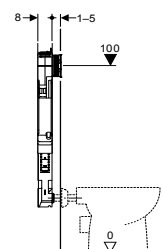
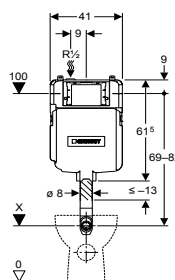
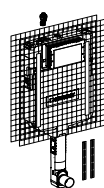

CASSETTE **■ GEBERIT**

SIGMA8	Descrizione	Art.	Min. Ord.	Prezzo
	Cassetta da incasso Sigma8, 8 cm di spessore, solo per WC a pavimento	WCC003	1	€ 382,24





	Descrizione	Art.	Colore	Min. Ord.	Prezzo
	Cassetta Geberit AP110 con Tasto Stop capacità 9 litri	WCC004	Bianco	1	€ 67,37

	Descrizione	Art.	Colore	Min. Ord.	Prezzo
	Cassetta Geberit AP117 con doppio tasto capacità 3 / 9 litri	WCC005	Bianco	1	€ 91,08

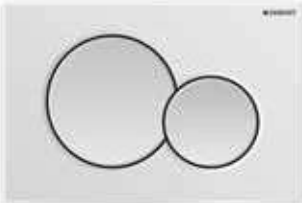
ACCESSORI CASSETTE

	Descrizione	Art.	Colore	Min. Ord.	Prezzo
 ■ GEBERIT	Placca sigma01 bianca 2 tasti per cassetta geberit unica+	WCC006	Bianco	1	€ 128,96

	Descrizione	Art.	Colore	Min. Ord.	Prezzo
 ■ GEBERIT	Placca sigma01 cromo 2 tasti per cassetta geberit unica+	WCC007	Cromo	1	€ 181,35

	Descrizione	Art.		Min. Ord.	Prezzo
	Campana completa per cassetta di scarico ad incasso twico geberit	WCC008		1	€ 58,43

	Descrizione	Art.	Ø	Min. Ord.	Prezzo
 ■ GEBERIT	Rubinetto a galleggiante Geberit Tipo 380, allacciamento idrico laterale, 3/8", codolo in ottone	WCC009	3/8"	1	€ 93,70

ACCESSORI CASSETTE

	Descrizione	Art.		Min. Ord.	Prezzo
	Valvola scarico per cassetta esterna Geberit cod. ap117	WCC010		1	€ 24,92

	Descrizione	Art.		Min. Ord.	Prezzo
	Valvola scarico per cassetta esterna Geberit cod. Ap110	WCC011		1	€ 16,02

	Descrizione	Art.	Ø	Min. Ord.	Prezzo
	Rubinetto galleggiante per cassette esterne Geberit	WCC012	3/8"	1	€ 27,54

	Descrizione	Art.	Colore	Min. Ord.	Prezzo
	Tubi per cassetta wc zaino universali	WCC013	Bianco	1	€ 8,16

ACCESSORI CASSETTE

	Descrizione	Art.		Min. Ord.	Prezzo
	Canotto di risciacquo per cassette ad incasso \varnothing 40/45 mm. in polipropilene PP + ABS bianco (tipo Geberit)	WCC014		3	€ 10,58

	Descrizione	Art.	\varnothing int - \varnothing est	Min. Ord.	Prezzo
	Morsetto wc in gomma tipo standard \varnothing 30 mm interno \varnothing 50 mm esterno	WCC015	30 - 50	1	€ 1,28

	Descrizione	Art.	\varnothing int - \varnothing est	Min. Ord.	Prezzo
	Morsetto wc Siphonic in gomma bianca \varnothing 30 mm interno \varnothing 55 mm esterno	WCC016	30 - 55	1	€ 1,24

	Descrizione	Art.	\varnothing int - \varnothing est	Min. Ord.	Prezzo
	Morsetto wc	WCC017	40 - 60	1	€ 2,12

CASSETTE ESTERNE

COMPACT PS	Descrizione	Art.	Colore	Min. Ord.	Prezzo
	Cassetta esterna a 1 tasto senza rubinetto esterno di collegamento	WCC018	Bianco	1	€ 43,52

COMPACT PS DUO	Descrizione	Art.	Colore	Min. Ord.	Prezzo
	Cassetta esterna a 2 tasti senza rubinetto esterno di collegamento	WCC019	Bianco	1	€ 55,01

VALVOLE PER CASSETTE

	Descrizione	Art.	Min. Ord.	Prezzo
	Valvola scarico per cassetta esterna COMPACT PS a 1 tasto	WCC020	1	€ 21,49

	Descrizione	Art.	Min. Ord.	Prezzo
	Valvola scarico per cassetta esterna COMPACT PS a 2 tasti	WCC021	1	€ 30,56

	Descrizione	Art.	Min. Ord.	Prezzo
	Valvola scarico per cassetta esterna LIV VISION a 1 tasto	WCC022	1	€ 38,72

RUBINETTI PER CASSETTE

	Descrizione	Art.	Min. Ord.	Prezzo
	Rubinetto galleggiante per cassetta LIV	WCC023	1	€ 24,72

	Descrizione	Art.	Ø	Min. Ord.	Prezzo
	Rubinetto per cassetta WC prolungato con raccordo	WCC024	3/8"	1	€ 13,87

SEDILI WC

	Descrizione	Art.	Min. Ord.	Prezzo
	Sedile in termoplastico con cerniere inox regolabili con alette fissaggio dal basso adattabile alla serie TESI	WCC109	1	€ 70,66

	Descrizione	Art.	Min. Ord.	Prezzo
	Sedile in duroplast per vaso Colibri, colore bianco lucido, cerniere in acciaio inox, fissaggio dal basso	WCC110	1	€ 86,07

	Descrizione	Art.	Min. Ord.	Prezzo
	Sedile in duroplast per vaso Selnova, colore bianco, cerniere in acciaio inox, fissaggio dal basso	WCC111	1	€ 81,94

	Descrizione	Art.	Min. Ord.	Prezzo
	Sedile in termoplastico con cerniere inox fissaggio dall'alto ad espansione; Adattabile a serie: GEMMA, TONIC, FANTASIA, RIO	WCC112	1	€ 53,63

FISSAGGIO

	Descrizione	Art.	Min. Ord.	Prezzo
	Coppia cerniere in metallo per sedili wc in legno	WCC113	1	€ 12,22

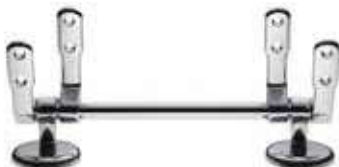
	Descrizione	Art.	Min. Ord.	Prezzo
	Cerniera universale modello America	WCC114	1	€ 15,68

	Descrizione	Art.	Min. Ord.	Prezzo
	Coppia cerniere universali ad espansione centrale	WCC115	1	€ 16,42

	Descrizione	Art.	Min. Ord.	Prezzo
	Coppia cerniere universali ad espansione laterale	WCC116	1	€ 26,33

FISSAGGIO E DISGORGANTE

	Descrizione	Art.	Min. Ord.	Prezzo
	Coppia cerniere universali sovrapposte con viti	WCC117	1	€ 13,84

	Descrizione	Art.	Min. Ord.	Prezzo
	Coppia cerniere universali in zama per copri vaso in plastica	WCC118	1	€ 8,50

	Descrizione	Art.	Min. Ord.	Prezzo
	Disgorgante liquido Spac nuova formula 1 litro	WCC119	1	€ 5,00













OPITEC

rubinetteria

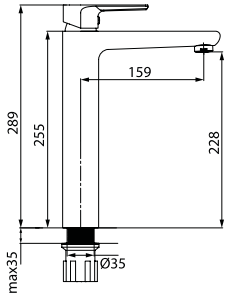
MISCELATORI LINEA HOPE

	Descrizione	Art.	Prezzo
	<p>miscelatore monocomando lavabo, finitura cromo, leva in metallo, cartuccia a dischi ceramici Ø 35 mm, completo di piletta da 1"1/4 in pvc, flessibili inox 3/8F lunghezza 35 cm, set di fissaggio</p> <div style="display: flex; justify-content: space-around; align-items: center;">    </div>	WCC120	€ 119,89
			

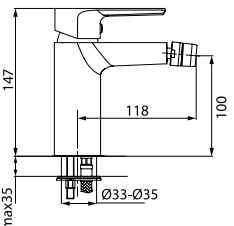

	Descrizione	Art.	Prezzo
	<p>miscelatore monocomando lavabo alto, finitura cromo, cartuccia a dischi ceramici Ø 35 mm, flessibili inox 3/8F lunghezza 35 cm, set di fissaggio</p> <div style="display: flex; justify-content: space-around; align-items: center;">   </div>	WCC124	€ 169,26
			

	Descrizione	Art.	Prezzo
	<p>miscelatore monocomando bidet, finitura cromo, leva in metallo, cartuccia a dischi ceramici Ø 35 mm, completo di piletta da 1"1/4 in pvc, flessibili inox 3/8F, lunghezza 35 cm, set di fissaggio</p> <div style="display: flex; justify-content: space-around; align-items: center;">    </div>	WCC121	€ 122,71
			

MISCELATORI LINEA HOPE

	Descrizione	Art.	Prezzo
	<p>miscelatore monocomando vasca, finitura cromo, leva in metallo cartuccia a dischi ceramici Ø 35 mm, completo di raccordi eccentrici e rosette copimuro</p>	WCC122	€ 137,52
			
			

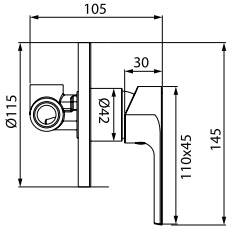

	Descrizione	Art.	Prezzo
	<p>miscelatore monocomando esterno doccia, finitura cromo, leva in metallo, cartuccia a dischi ceramici Ø 35 mm, completo di raccordi eccentrici e rosette copimuro</p>	WCC123	€ 102,26
			
			



	Descrizione	Art.	Prezzo
	<p>miscelatore monocomando incasso doccia, finitura cromo, leva in metallo, cartuccia a dischi ceramici Ø 35 mm</p>	WCC125	€ 56,42
			
			

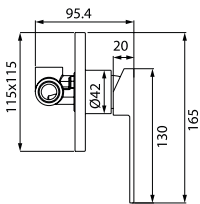

MISCELATORI LINEA EDEN

	Descrizione	Art.	Prezzo
	<p>miscelatore monocomando lavabo, finitura cromo, leva in metallo, cartuccia a dischi ceramici Ø 25 mm, completo di piletta da 1"1/4 in metallo, flessibili inox 3/8F lunghezza 35 cm, set di fissaggio</p> <p>    </p>	WCC126	€ 114,85
			
	<p>miscelatore monocomando bidet, finitura cromo, leva in metallo, cartuccia a dischi ceramici Ø 25 mm, completo di piletta da 1"1/4 in metallo, flessibili inox 3/8F, lunghezza 35 cm, set di fissaggio</p> <p>    </p>	WCC127	€ 114,69
			
	<p>miscelatore monocomando vasca, finitura cromo, leva in metallo, cartuccia a dischi ceramici Ø 25 mm, completo di raccordi eccentrici e rosette coprimuro</p> <p>   </p>	WCC128	€ 145,18
			
	<p>miscelatore monocomando esterno doccia, finitura cromo, leva in metallo, cartuccia a dischi ceramici Ø 25 mm, completo di raccordi eccentrici e rosette coprimuro</p> <p>   </p>	WCC129	€ 114,52
			



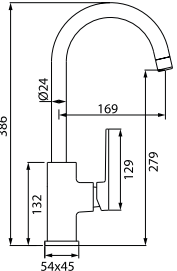

MISCELATORI LINEA EDEN

	Descrizione	Art.	Prezzo
	<p>miscelatore monocomando incasso doccia, finitura cromo, leva in metallo, cartuccia a dischi ceramici Ø 35 mm</p> 	WCC131	€ 61,89
			



	Descrizione	Art.	Prezzo
	<p>miscelatore monocomando incasso doccia, finitura cromo, leva in metallo, cartuccia a dischi ceramici Ø 35 mm, con deviatore</p> 	WCC132	€ 125,20
			

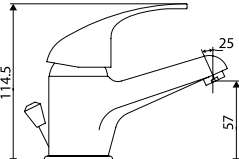

	Descrizione	Art.	Prezzo
	<p>miscelatore monocomando lavello bocca alta, finitura cromo, leva in metallo, cartuccia a dischi ceramici Ø 25 mm, flessibili inox 3/8F, lunghezza 35 cm, set di fissaggio</p>  	WCC130	€ 110,02
			

MISCELATORI LINEA FAST

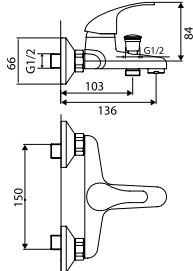

	Descrizione	Art.	Prezzo
	<p>miscelatore monocomando lavabo, finitura cromo, leva in metallo, cartuccia a dischi ceramici Ø 35 mm, completo di piletta da 1"1/4 in pvc, flessibili inox 3/8F lunghezza 35 cm, set di fissaggio</p> <p>  </p>	WCC133	€ 40,40
			

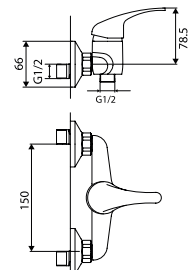

	Descrizione	Art.	Prezzo
	<p>miscelatore monocomando bidet, finitura cromo, leva in metallo, cartuccia a dischi ceramici Ø 35 mm, completo di piletta da 1"1/4 in pvc, flessibili inox 3/8F, lunghezza 35 cm, set di fissaggio</p> <p>  </p>	WCC134	€ 40,40
			



	Descrizione	Art.	Prezzo
	<p>miscelatore monocomando vasca, finitura cromo, leva in metallo, cartuccia a dischi ceramici Ø 35 mm, completo di raccordi eccentrici e rosette coprimuro</p> <p> </p>	WCC135	€ 54,57
			

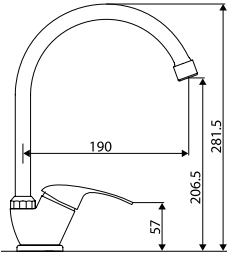

	Descrizione	Art.	Prezzo
	<p>miscelatore monocomando esterno doccia, finitura cromo, leva in metallo, cartuccia a dischi ceramici Ø 35 mm, completo di raccordi eccentrici e rosette coprimuro</p> <p> </p>	WCC136	€ 40,40
			

MISCELATORI LINEA FAST

	Descrizione	Art.	Prezzo
	<p>miscelatore monocomando incasso doccia, finitura cromo, leva in metallo, cartuccia a dischi ceramici Ø 35 mm</p> 	WCC137	€ 31,27
			

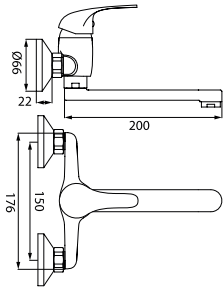
	Descrizione	Art.	Prezzo
	<p>miscelatore monocomando lavello finitura cromo, leva in metallo, cartuccia a dischi ceramici Ø 35 mm, flessibili inox 3/8F lunghezza 35 cm, set di fissaggio</p>  	WCC138	€ 46,81
			

	Descrizione	Art.	Prezzo
	<p>Miscelatore monocomando lavello bocca girevole con attacco a parete, finitura cromo, leva in metallo, cartuccia a dischi ceramici Ø 35 mm, completo di raccordi eccentrici e rosette coprimuro</p>  	WCC139	€ 54,07
			

	Descrizione	Art.	Prezzo
	<p>Miscelatore monocomando lavabo, finitura cromo, cartuccia a dischi ceramici Ø 40 mm, completo di piletta da 1"1/4, flessibili inox 3/8F, lunghezza 44,5 cm, set di fissaggio</p> <div style="display: flex; justify-content: space-around; align-items: center;">    </div>	WCC038	€ 118,48

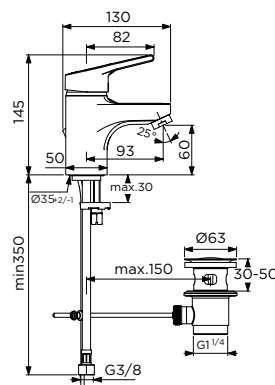

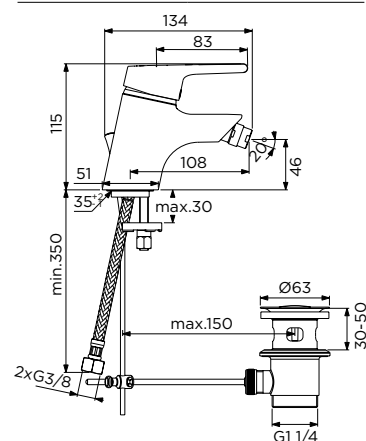

	Descrizione	Art.	Prezzo
	<p>Miscelatore monocomando bidet, finitura cromo, cartuccia a dischi ceramici Ø 40 mm, completo di piletta da 1"1/4, flessibili inox 3/8F, lunghezza 44,5 cm, set di fissaggio</p> <div style="display: flex; justify-content: space-around; align-items: center;">    </div>	WCC039	€ 118,48





MISCELATORI LINEA IDRO ONE

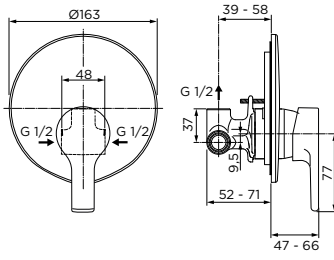

	Descrizione	Art.	Prezzo
	<p>Miscelatore monocomando vasca, finitura cromo, cartuccia a dischi ceramici Ø 40 mm, completo di raccordi eccentrici e rosette coprimuro</p> <div style="display: flex; justify-content: space-around; align-items: center;">   </div>	WCC040	€ 177,35
			



	Descrizione	Art.	Prezzo
	<p>Miscelatore monocomando incasso doccia, finitura cromo, cartuccia a dischi ceramici Ø 47 mm</p> <div style="display: flex; justify-content: center; align-items: center;">  </div>	WCC041	€ 94,27
			

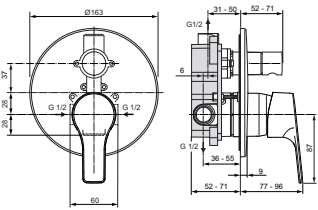

IDEALSTREAM	Descrizione	Art.	Prezzo
	<p>Miscelatore monocomando lavabo, finitura cromo, leva in metallo, cartuccia a dischi ceramici Ø 35 mm, completo di piletta da 1"1/4 in metallo, flessibili inox 3/8F lunghezza 35 cm, set di fissaggio Easy fix</p>	WCC140	€ 97,83
			

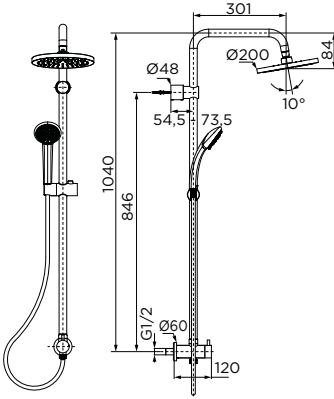

IDEALSTREAM	Descrizione	Art.	Prezzo
	<p>Miscelatore monocomando incasso doccia con deviatore, finitura cromo, con attacchi di alimentazione e scarico da 1/2", cartuccia a dischi ceramici Ø 47 mm con sistema EKO, Corpo ad incasso incluso nella confezione</p>	WCC142	€ 167,14
			

IDEALRANGE	Descrizione	Art.	Prezzo
	<p>Miscelatore monocomando esterno doccia, finitura cromo, cartuccia a dischi ceramici Ø 35 mm, completo di raccordi eccentrici e rosette copimuro</p> <div style="display: flex; justify-content: space-around; align-items: center;">   </div>	<p>WCC144</p>	<p>€ 108,61</p> <div style="text-align: right;">  </div>



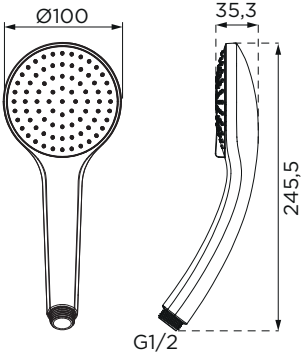

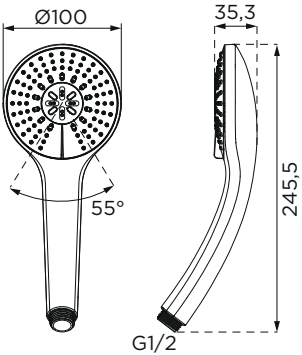

IDEALRANGE	Descrizione	Art.	Prezzo
	<p>Miscelatore monocomando vasca, finitura cromo, cartuccia a dischi ceramici Ø 35 mm, completo di raccordi eccentrici e rosette copimuro</p> <div style="display: flex; justify-content: space-around; align-items: center;">   </div>	<p>WCC145</p>	<p>€ 135,05</p> <div style="text-align: right;">  </div>

IDEALJET	Descrizione	Art.	Prezzo
	<p>Colonna doccia, supporto doccetta con scorrimento a pressione per una facile regolazione. Doccetta di diametro 80 mm con riduttore di portata a 8 l/min. Soffione di diametro 200 mm. Asta murale da 1051 mm e diametro 25 mm con fissaggi a muro regolabili. Tubo flessibile ultraflex, in materiale plastico ad effetto metallico, da 1750 mm.</p> <div style="display: flex; justify-content: space-around; align-items: center;">   </div>	<p>WCC047</p>	<p>€ 470,33</p>
			

IDEALRAIN	Descrizione	Art.	Prezzo
	<p>Doccia, ABS cromato, 1 getto, anticalcare, diametro 100 mm, riduttore di portata 8 l/min, attacco universale da 1/2"</p> <div style="display: flex; justify-content: space-around;">   </div>	WCC048	€ 31,33
			

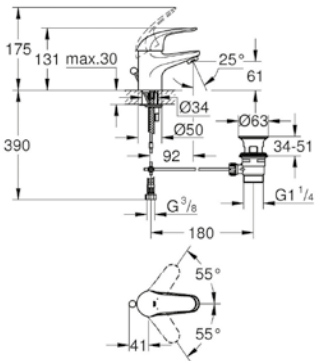
IDEALRAIN	Descrizione	Art.	Prezzo
	<p>Doccia, ABS cromato, 3 getti, anticalcare, diametro 100 mm, riduttore di portata 8 l/min, attacco universale da 1/2"</p> <div style="display: flex; justify-content: space-around;">   </div>	WCC049	€ 56,25
			

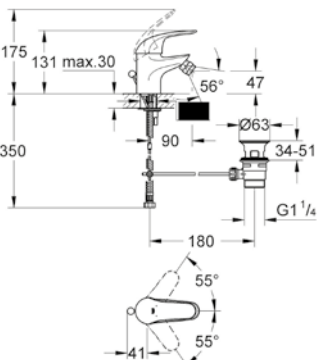
IDEALJET	Descrizione	Art.	Prezzo
	<p>Flessibile doccia, metallo cromato, doppia aggraffatura, sistema antitorsione, lunghezza 1750 mm, attacco universale da 1/2"</p> <div style="display: flex; justify-content: space-around;">   </div>	WCC050	€ 19,55
			

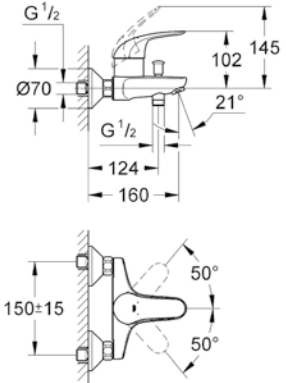
	Descrizione	Art.	Prezzo
	<p>Miscelatore monocomando lavabo, finitura cromo, cartuccia a dischi ceramici Ø 35 mm, completo di piletta da 1"1/4, flessibili inox 3/8F lunghezza 35 cm, set di fissaggio</p> <div data-bbox="710 721 1077 824">  </div>	WCC052	€ 168,12
			
	<p>Miscelatore monocomando bidet, finitura cromo, cartuccia a dischi ceramici Ø 35 mm, completo di piletta da 1"1/4, flessibili inox 3/8F, lunghezza 35 cm, set di fissaggio</p> <div data-bbox="710 1303 1077 1406">  </div>	WCC053	€ 168,12
			
	<p>Miscelatore monocomando vasca, finitura cromo, cartuccia a dischi ceramici Ø 46 mm, completo di raccordi eccentrici e rosette coprimuro</p> <div data-bbox="769 1899 1002 2002">  </div>	WCC054	€ 211,61
			

MISCELATORI LINEA START ECO/SWIFT **GROHE**

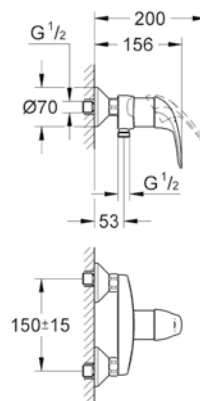

	Descrizione	Art.	Prezzo
	<p>Miscelatore monocomando esterno doccia, finitura cromo, cartuccia a dischi ceramici Ø 46 mm, completo di raccordi eccentrici e rosette coprimuro</p> <div style="display: flex; justify-content: space-around; align-items: center;">   </div>	WCC055	€ 168,12





	Descrizione	Art.	Prezzo
	<p>Miscelatore monocomando lavabo, finitura cromo, cartuccia a dischi ceramici Ø 28 mm, completo di piletta da 1"1/4, flessibili inox 3/8F lunghezza 35 cm, set di fissaggio</p> <div data-bbox="710 761 1077 862">  </div>	WCC057	€ 176,81
			

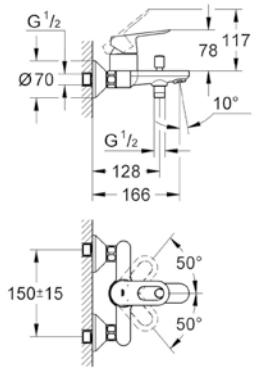

	Descrizione	Art.	Prezzo
	<p>Miscelatore monocomando bidet, finitura cromo, cartuccia a dischi ceramici Ø 28 mm, completo di piletta da 1"1/4, flessibili inox 3/8F, lunghezza 35 cm, set di fissaggio</p> <div data-bbox="710 1467 1077 1568">  </div>	WCC058	€ 176,81
			

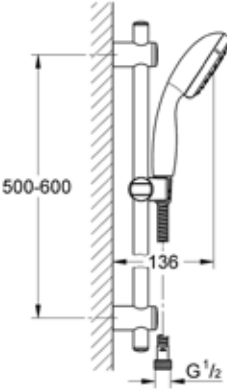

MISCELATORI LINEA START LOOP **GROHE**

	Descrizione	Art.	Prezzo
	<p>Miscelatore monocomando vasca, finitura cromo, cartuccia a dischi ceramici Ø 46 mm, completo di raccordi eccentrici e rosette coprimuro</p> <div style="display: flex; justify-content: space-around; align-items: center;">   </div>	WCC059	€ 216,37
			

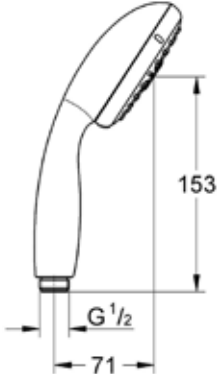

	Descrizione	Art.	Prezzo
	<p>Miscelatore monocomando esterno doccia, finitura cromo, cartuccia a dischi ceramici Ø 46 mm, completo di raccordi eccentrici e rosette coprimuro</p> <div style="display: flex; justify-content: space-around; align-items: center;">   </div>	WCC060	€ 176,81
			

VITALIO START	Descrizione	Art.	Prezzo
	<p>Set saliscendi, ABS cromato, 2 getti, anticalcare, diametro 100 mm, attacco universale da 1/2", asta doccia 600 mm, supporti fissi, flessibile 1750 mm, EcoJoy®</p> <div style="display: flex; justify-content: center; gap: 20px;">   </div>	<p>WCC063</p>	<p>€ 139,03</p>
			

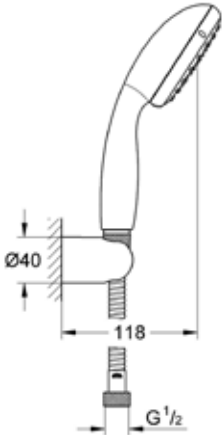

VITALIO START	Descrizione	Art.	Prezzo
	<p>Doccia, ABS cromato, 2 getti, anticalcare, diametro 100 mm, attacco universale da 1/2", GROHE EcoJoy</p> <div style="display: flex; justify-content: space-around; align-items: center;">   </div>	WCC064	€ 57,43
			



VITALIO START	Descrizione	Art.	Prezzo
	<p>Duplex, ABS cromato, 2 getti, anticalcare, diametro 100 mm, supporto fisso, flessibile 1750 mm, attacco universale da 1/2", GROHE EcoJoy</p> <div style="display: flex; justify-content: space-around; align-items: center;">   </div>	WCC065	€ 90,37
			

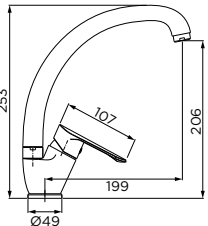

VITALIOFLEX METAL	Descrizione	Art.	Prezzo
	<p>Flessibile doccia, metallo cromato, sistema antitorsione, lunghezza 1500 mm, attacco universale da 1/2"</p> 	WCC066	€ 70,73
			

VITALIOFLEX SILVER	Descrizione	Art.	Prezzo
	<p>Flessibile doccia, plastica cromato, sistema antitorsione, lunghezza 1750 mm, attacco universale da 1/2"</p> 	WCC067	€ 58,13
			

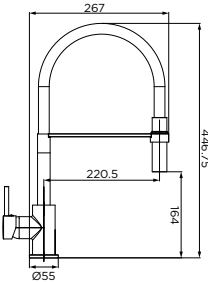

LAVELLI CUCINA

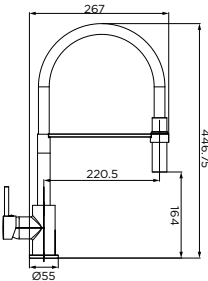

BOSTON	Descrizione	Art.	Prezzo
	<p>Miscelatore monocomando lavello bocca alta, finitura cromo, leva in metallo, cartuccia a dischi ceramici Ø 35 mm, flessibili inox 3/8F, lunghezza 35 cm, set di fissaggio</p> <div style="display: flex; justify-content: space-around; align-items: center;">   </div>	WCC146	€ 74,05
			

WINTER NERO	Descrizione	Art.	Prezzo
	<p>Miscelatore monocomando lavello bocca alta, doccetta monogetto orientabile in ottone, finitura cromo, tubo in gomma nero, leva in metallo, cartuccia a dischi ceramici Ø 35 mm, flessibili inox 3/8F, lunghezza 40 cm, set di fissaggio facile e veloce</p> <div style="display: flex; justify-content: space-around; align-items: center;">   </div>	WCC147	€ 155,59
			

WINTER TORTORA	Descrizione	Art.	Prezzo
	<p>miscelatore monocomando lavello bocca alta, doccetta monogetto orientabile in ottone, finitura cromo, tubo in gomma tortora, leva in metallo, cartuccia a dischi ceramici Ø 35 mm, flessibili inox 3/8F, lunghezza 40 cm, set di fissaggio facile e veloce</p> <div style="display: flex; justify-content: space-around; align-items: center;">   </div>	WCC148	€ 144,57
			

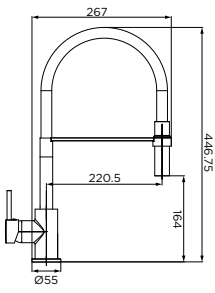

LAVELLI CUCINA

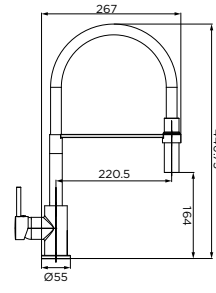
WINTER GRIGIO	Descrizione	Art.	Prezzo
	<p>Miscelatore monocomando livello bocca alta, doccetta monogetto orientabile in ottone, finitura cromo, tubo in gomma grigio, leva in metallo, cartuccia a dischi ceramici Ø 35 mm, flessibili inox 3/8F, lunghezza 40 cm, set di fissaggio facile e veloce</p>	WCC149	€ 144,57
	 		

WINTER BIANCO	Descrizione	Art.	Prezzo
	<p>Miscelatore monocomando livello bocca alta, doccetta monogetto orientabile in ottone, finitura cromo, tubo in gomma bianco, leva in metallo, cartuccia a dischi ceramici Ø 35 mm, flessibili inox 3/8F, lunghezza 40 cm, set di fissaggio facile e veloce</p>	WCC150	€ 144,57
	 		

DENVER	Descrizione	Art.	Prezzo
	<p>Miscelatore monocomando livello a molla in acciaio, con doccetta abs 2 getti con aggancio magnetico, canna alta orientabile, corpo in ottone, leva in metallo, finitura cromo cartuccia a dischi ceramici ø 40 mm, flessibili inox F3/8, lunghezza 40 cm DVGW, set di fissaggio rapido</p>	WCC151	€ 168,02
	 		

LAVELLI CUCINA

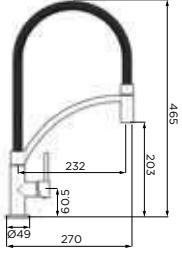
ORLANDO	Descrizione	Art.	Prezzo
	<p>Miscelatore monocomando livello bocca alta, doccetta monogetto orientabile in ottone, finitura cromo, tubo acciaio, leva in metallo, cartuccia a dischi ceramici Ø 25 mm, flessibili inox 3/8F, lunghezza 40 cm, set di fissaggio</p> <div style="display: flex; justify-content: center; gap: 20px;">   </div>	WCC152	€ 177,02
			

ACCESSORI BAGNO AQUASANIT

ATTRACTIVE	Descrizione	Art.	Min. Ord.	Prezzo
	Mensola angolare per zona doccia realizzata in alluminio, 1 ripiano, finitura cromata garantita contro la ruggine fissaggio con viti e tasselli inclusi cm. L. 31 x H. 6 x P. 20,5	WCC155	1	€ 55,92

PREMIUM COLLECTION

ATTRACTIVE	Descrizione	Art.	Min. Ord.	Prezzo
	Mensola rettangolare per zona doccia realizzata in alluminio, 1 ripiano, finitura cromata garantita contro la ruggine fissaggio con viti e tasselli inclusi cm. L. 26 x H. 14 x P. 12,5	WCC156	1	€ 55,68

PREMIUM COLLECTION









ATTRACTIVE	Descrizione	Art.	Min. Ord.	Prezzo
	Mensola angolare per zona doccia realizzata in alluminio, 2 ripiani, finitura cromata garantita contro la ruggine fissaggio con viti e tasselli inclusi cm. L. 31 x H. 39 x P. 20,8	WCC157	1	€ 123,35

PREMIUM COLLECTION









ATTRACTIVE	Descrizione	Art.	Min. Ord.	Prezzo
	Mensola rettangolare per zona doccia realizzata in alluminio, 2 ripiani, finitura cromata garantita contro la ruggine fissaggio con viti e tasselli inclusi cm. L. 25,5 x H. 39 x P. 12,5	WCC158	1	€ 116,20

PREMIUM COLLECTION



ACCESSORI BAGNO AQUASANIT



WIRE	Descrizione	Art.	Min. Ord.	Prezzo
 	<p>Mensola serie Wire realizzata in zama e acciaio con corredi in vetro, disponibile in finitura cromo.</p> <p>Fissaggio con viti e tasselli inclusi, opzionale fissaggio ad incollo.</p> <p>cm. L. 60,8 x H. 5,6 x P. 14,4</p>	WCC159	4	€ 58,64
 	<p>Porta bicchiere serie Wire realizzato in zama e acciaio con corredi in vetro, disponibile in finitura cromo.</p> <p>Fissaggio con viti e tasselli inclusi, opzionale fissaggio ad incollo.</p> <p>cm. L. 7,6 x H. 11,2 x P. 11,5</p>	WCC160	4	€ 19,08
 	<p>Porta sapone serie Wire realizzato in zama e acciaio con corredi in vetro, disponibile in finitura cromo.</p> <p>Fissaggio con viti e tasselli inclusi, opzionale fissaggio ad incollo.</p> <p>cm. L. 10,9 x H. 9,5 x P. 13,3</p>	WCC161	4	€ 20,62
 	<p>Porta scopino serie Wire realizzato in zama e acciaio con bacinella in vetro, disponibile in finitura cromo.</p> <p>Fissaggio con viti e tasselli inclusi, opzionale fissaggio ad incollo.</p> <p>cm. L. 11,5 x H. 38 x P. 15,5</p>	WCC162	4	€ 43,36



ACCESSORI BAGNO AQUASANIT

WIRE	Descrizione	Art.	Min. Ord.	Prezzo
 	<p>Porta salviette a snodo serie Wire realizzato in zama e acciaio, disponibile in finitura cromo. Fissaggio con viti e tasselli inclusi, opzionale fissaggio ad incollo. cm. L. 43,2 x H. 6 x P. 2,7</p>	WCC163	4	€ 34,56
 	<p>Porta abito 2 posti serie Wire realizzato in zama e acciaio, disponibile in finitura cromo. Fissaggio con viti e tasselli inclusi, opzionale fissaggio ad incollo. cm. L. 8,4 x H. 5,4 x P. 5,1</p>	WCC164	4	€ 10,75
 	<p>Porta rotolo aperto serie Wire realizzato in zama e acciaio, disponibile in finitura cromo. Fissaggio con viti e tasselli inclusi, opzionale fissaggio ad incollo. cm. L. 17 x H. 5,4 x P. 8,7</p>	WCC165	4	€ 14,54
 	<p>Porta salviette per bidet serie Wire realizzato in zama e acciaio, disponibile in finitura cromo. Fissaggio con viti e tasselli inclusi, opzionale fissaggio ad incollo. cm. L. 23,2 x H. 5,4 x P. 8,7</p>	WCC166	1	€ 17,19









ACCESSORI BAGNO AQUASANIT

WIRE	Descrizione	Art.	Min. Ord.	Prezzo
 	<p>Porta salviette 30cm serie Wire realizzato in zama e acciaio, disponibile in finitura cromo. Fissaggio con viti e tasselli inclusi, opzionale fissaggio ad incollo. cm. L. 30 x H. 5,4 x P. 7,7</p>	WCC167	4	€ 25,76



WIRE	Descrizione	Art.	Min. Ord.	Prezzo
 	<p>Porta salviette 45cm serie Wire realizzato in zama e acciaio, disponibile in finitura cromo. Fissaggio con viti e tasselli inclusi, opzionale fissaggio ad incollo. cm. L. 45 x H. 5,4 x P. 7,7</p>	WCC168	4	€ 29,62



WIRE	Descrizione	Art.	Min. Ord.	Prezzo
 	<p>Porta salviette 60cm serie Wire realizzato in zama e acciaio, disponibile in finitura cromo. Fissaggio con viti e tasselli inclusi, opzionale fissaggio ad incollo. cm. L. 60 x H. 5,4 x P. 7,7</p>	WCC169	4	€ 34,12



ACCESSORI BAGNO AQUASANIT



CUBO	Descrizione	Art.	Min. Ord.	Prezzo
 	<p>Mensola serie Cubo realizzata in zama e acciaio con corredi in vetro, disponibile in finitura cromo. Fissaggio con viti e tasselli inclusi, opzionale fissaggio ad incollo. cm. L. 61 x H. 4,5 x P. 12,8</p>	WCC170	4	€ 53,13
 	<p>Porta bicchiere serie Cubo realizzato in zama e acciaio con corredi in vetro, disponibile in finitura cromo. Fissaggio con viti e tasselli inclusi, opzionale fissaggio ad incollo. cm. L. 7,5 x H. 11,6 x P. 9,4</p>	WCC171	4	€ 28,04
 	<p>Porta sapone serie Cubo realizzato in zama e acciaio con corredi in vetro, disponibile in finitura cromo. Fissaggio con viti e tasselli inclusi, opzionale fissaggio ad incollo. cm. L. 11,5 x H. 4,5 x P. 9,7</p>	WCC172	4	€ 24,68
 	<p>Porta scopino serie Cubo realizzato in zama e acciaio con bacinella in vetro, disponibile in finitura cromo. Fissaggio con viti e tasselli inclusi, opzionale fissaggio ad incollo. cm. L. 9,5 x H. 37 x P. 11,2</p>	WCC173	4	€ 57,90

ACCESSORI BAGNO AQUASANIT



CUBO	Descrizione	Art.	Min. Ord.	Prezzo
 	<p>Porta salviette a snodo serie Cubo realizzato in zama e acciaio, disponibile in finitura cromo. Fissaggio con viti e tasselli inclusi, opzionale fissaggio ad incollo. cm. L. 42,8 x H. 6,2 x P. 3,3</p>	WCC174	4	€ 41,61

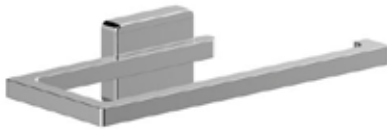

CUBO	Descrizione	Art.	Min. Ord.	Prezzo
 	<p>Porta abito 2 posti serie Cubo realizzato in zama e acciaio, disponibile in finitura cromo. Fissaggio con viti e tasselli inclusi, opzionale fissaggio ad incollo. cm. L. 9 x H. 4,5 x P. 4,7</p>	WCC175	4	€ 13,40



CUBO	Descrizione	Art.	Min. Ord.	Prezzo
 	<p>Porta rotolo aperto serie Cubo realizzato in zama e acciaio, disponibile in finitura cromo. Fissaggio con viti e tasselli inclusi, opzionale fissaggio ad incollo. cm. L. 14 x H. 4,5 x P. 8,7</p>	WCC176	4	€ 19,04

CUBO	Descrizione	Art.	Min. Ord.	Prezzo
 	<p>Porta salviette per bidet serie Cubo realizzato in zama e acciaio, disponibile in finitura cromo. Fissaggio con viti e tasselli inclusi, opzionale fissaggio ad incollo. cm. L. 20 x H. 4,5 x P. 8,7</p>	WCC177	4	€ 22,94

ACCESSORI BAGNO AQUASANIT



CUBO	Descrizione	Art.	Min. Ord.	Prezzo
	Porta salviette 30cm serie Cubo realizzato in zama e acciaio, disponibile in finitura cromo. Fissaggio con viti e tasselli inclusi, opzionale fissaggio ad incollo. cm. L. 30 x H. 4,5 x P. 8,2	WCC178	4	€ 36,67
				

CUBO	Descrizione	Art.	Min. Ord.	Prezzo
	Porta salviette 45cm serie Cubo realizzato in zama e acciaio, disponibile in finitura cromo. Fissaggio con viti e tasselli inclusi, opzionale fissaggio ad incollo. cm. L. 45 x H. 4,5 x P. 8,2	WCC179	4	€ 39,86
				

CUBO	Descrizione	Art.	Min. Ord.	Prezzo
	Porta salviette 60cm serie Cubo realizzato in zama e acciaio, disponibile in finitura cromo. Fissaggio con viti e tasselli inclusi, opzionale fissaggio ad incollo. cm. L. 60 x H. 4,5 x P. 8,2	WCC180	4	€ 43,39
				

FISSAGGIO A COLLA	Descrizione	Art.	Prezzo
	Aquasanit colla bicomponente 11 gr. Professionale per un fissaggio garantito senza bisogno di forare, adatto per una vasta gamma di accessori. Adatto per superfici (metallo, vetro, pietra, piastrelle, legno). Completamente removibile.	WCC181	€ 10,58



COLONNE DOCCIA

LIGHT	Descrizione	Art.	Prezzo
	<p>Colonna doccia, metallo cromato, soffione ABS Ø 15 cm, 1 getto anticalcare, doccetta cromata 5 getti anticalcare, economizzatore risparmio acqua, asta doccia regolabile, flessibile acciaio lunghezza 1500 mm, deviatore a 2 vie in ottone</p> <div data-bbox="719 725 1066 824"> </div>	WCC068	€ 138,87
	<p>Colonna doccia, ottone cromato, soffione ABS Ø 25 cm, 1 getto anticalcare, doccetta cromata 3 getti anticalcare, asta doccia regolabile Ø 32 mm, flessibile doppia aggraffatura lunghezza 1500 mm, deviatore a 2 vie in ottone</p> <div data-bbox="655 1317 1129 1415"> </div>	WCC069	€ 254,89
	<p>Colonna doccia con miscelatore monocomando esterno doccia, acciaio cromato, soffione ABS Ø 20 cm, 1 getto anticalcare, doccetta cromata 3 getti anticalcare, cartuccia a dischi ceramici Ø 40, completo di raccordi eccentrici e rosette copimuro, flessibile in metallo doppia aggraffatura lunghezza 1500 mm, deviatore a 2 vie in ottone</p> <div data-bbox="724 1944 1066 2042"> </div>	WCC070	€ 188,63

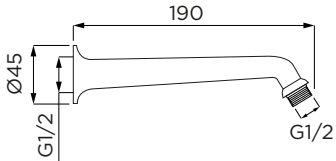
BRACCI DOCCIA

	Descrizione	Art.	Prezzo
	Braccio doccia, installazione a parete, metallo cromato, lunghezza 19 cm attacco universale da 1/2"	WCC073	€ 10,61
			

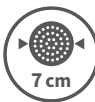
SOFFIONI

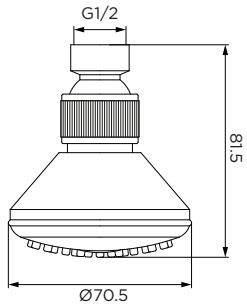
SNODO	Descrizione	Art.	Prezzo
	Soffione, metallo cromato, 1 getto, anticalcare, Ø 7 cm, attacco snodabile universale da 1/2"	WCC074	€ 14,21
	 		

STAMPATO A SNODO	Descrizione	Art.	Prezzo
	Soffione, metallo cromato, 1 getto, Ø 8 cm, attacco snodabile universale da 1/2"	WCC075	€ 11,05
	 		

NETTUNO	Descrizione	Art.	Prezzo
	Soffione, ABS cromato, 5 getti, anticalcare, Ø 9,3 cm, attacco snodabile universale da 1/2"	WCC076	€ 20,38
	 		

DOCCE

STAR	Descrizione	Art.	Prezzo
	<p>Doccia, ABS cromato, 3 getti, anticalcare, Ø 70 mm, attacco universale da 1/2"</p> <div style="display: flex; justify-content: space-around; align-items: center;">   </div>	WCC080	€9,54
			

DIESIS	Descrizione	Art.	Prezzo
	<p>Doccia, ABS cromato, 3 getti, anticalcare, Ø 85 mm, attacco universale da 1/2"</p> <div style="display: flex; justify-content: space-around; align-items: center;">   </div>	WCC081	€ 14,21
			

EVO	Descrizione	Art.	Prezzo
	<p data-bbox="753 459 1034 631">Doccia, ABS cromato, 5 getti, anticalcare, Ø 110 mm, attacco universale da 1/2"</p> <div data-bbox="778 786 1007 887">  </div>	<p data-bbox="1203 452 1305 481">WCC084</p>	<p data-bbox="1385 452 1471 481">€ 17,46</p> <div data-bbox="1193 555 1513 952">  </div>

TUBI FLESSIBILI

	Descrizione	Art.	Prezzo
	Flessibile acciaio, cromato, lunghezza 150 cm, attacco conico universale da 1/2"	WCC085	€ 9,44
			

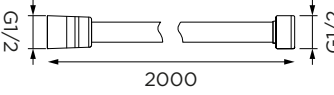
	Descrizione	Art.	Prezzo
	Flessibile acciaio, cromato, lunghezza 200 cm, attacco conico universale da 1/2"	WCC086	€ 10,91
			

ACCESSORI

	Descrizione	Art.	Prezzo
	<p>Supporto doccia a parete, ABS cromato, fisso, viti per fissaggio incluse</p>	WCC087	€ 3,73
			

	Descrizione	Art.	Prezzo
	<p>Scorrevole saliscendi, ABS cromato, Ø 25 mm, con supporto doccetta regolabile</p>	WCC088	€ 9,81
			

rubinetteria economica

MISCELATORI BAGNO VERONA

	Descrizione	Art.	Prezzo
	Rubinetto monocomando lavabo (contiene cartuccia 40 mm)	WCC091	€ 56,02

	Descrizione	Art.	Prezzo
	Miscelatore bidet (contiene cartuccia 40 mm)	WCC096	€ 52,84

	Descrizione	Art.	Prezzo
	Monocomando vasca esterno (contiene cartuccia 40 mm)	WCC089	€ 70,95

MISCELATORI CUCINA VERONA

	Descrizione	Art.	Prezzo
	Rubinetto monocomando lavello doccia (contiene cartuccia 40 mm)	WCC102	€ 63,48

	Descrizione	Art.	Prezzo
	Rubinetto monocomando lavello (contiene cartuccia 40 mm)	WCC090	€ 35,54

	Descrizione	Art.	Prezzo
	Rubinetto monocomando lavello (contiene cartuccia 40 mm)	WCC097	€ 40,33

rubinetteria economica

MISCELATORI BAGNO ANCONA

	Descrizione	Art.	Prezzo
	Rubinetto monocomando lavabo (contiene cartuccia 35 mm)	WCC095	€ 29,87

	Descrizione	Art.	Prezzo
	Miscelatore bidet (contiene cartuccia 35 mm)	WCC098	€ 31,74

MISCELATORI BAGNO ANCONA

	Descrizione	Art.	Prezzo
	Miscelatore vasca esterno (contiene cartuccia 35 mm)	WCC092	€ 46,68

	Descrizione	Art.	Prezzo
	Miscelatore doccia esterno (contiene cartuccia 35 mm)	WCC093	€ 35,47

	Descrizione	Art.	Prezzo
	Rubinetto monocomando lavello (contiene cartuccia 35 mm)	WCC094	€ 28,75

rubinetteria economica

MISCELATORI CUCINA

FLORIDA	Descrizione	Art.	Prezzo
	Rubinetto monocomando lavello (contiene cartuccia 40 mm)	WCC099	€ 63,48

CALIFORNIA	Descrizione	Art.	Prezzo
	Miscelatore lavello con canna flessibile (contiene cartuccia 40 mm)	WCC100	€ 168,05

MONACO	Descrizione	Art.	Prezzo
	Rubinetto monocomando lavello (contiene cartuccia 40 mm)	WCC101	€ 72,82

ACCESSORI

	Descrizione	Art.	Per mod.	Ø	Min. Ord.	Prezzo
	Cartuccia per miscelatori	WCC103	Verona - Monaco Florida - California collection	40	1	€ 5,67
		WCC104	Ancona collection	35	1	€ 5,67

	Descrizione	Art.	Ø	Min. Ord.	Prezzo
	Cartuccia piatta universale per mix	WCC105	35	1	€ 7,06
		WCC107	40	1	€ 7,06

	Descrizione	Art.	Ø	Min. Ord.	Prezzo
	Cartuccia alta universale per mix	WCC106	35	1	€ 7,06
		WCC108	40	1	€ 7,06







OPITEC

consumo - varie

CONSUMO

	Descrizione	Art.	Prezzo
	<p>Kit per installazione climatizzatore monosplit completo di tubo in rame lunghezza 5,0 mt, preisolato doppio da 1/4" - 3/8", completo di raccordi autocartellanti universali per tubi in rame e tubi in alluminio che evitano l'operazione di cartellatura, due da 1/4" e due da 3/8", completo di tubo per scarico condensa di lunghezza 5 metri</p>	VAR052	€ 126,27

	Descrizione	Art.	Ø mm	Min. Ord.	Prezzo
	Nastro PTFE	VAR001	1/2"x12x12	3	€ 0,91

	Descrizione	Art.	Ø mm	Min. Ord.	Prezzo
	Filamento professional PTFE Twinflon, lunghezza 175 mt	VAR053	-	3	€ 21,53

	Descrizione	Art.	Ø mm	Min. Ord.	Prezzo
	Filamento professional PTFE Cordflon, lunghezza 75 mt	VAR054	-	3	€ 11,22

CONSUMO

	Descrizione	Art.	mm x mm x mt	Min. Ord.	Prezzo
	Nastro Teflon	VAR025	gas 19x0,1x15	3	€ 2,15
		VAR026	gas 12x0,01x12	3	€ 0,67
		VAR027	acqua 12x0,075x10	3	€ 0,34

	Descrizione	Art.	Gr	Min. Ord.	Prezzo
	Pasta verde	VAR002	150	3	3,63

	Descrizione	Art.	Gr	Min. Ord.	Prezzo
	Canapa di prima qualità, pettinata meccanicamente in modo da renderlo fine e idoneo a guarnire tutti i tipi di filettature.	VAR003	50	3	€ 1,81
		VAR049	1000	3	€ 13,43

ASPIRAZIONE / VENTILAZIONE

	Descrizione	Art.	Min. Ord.	Prezzo
--	-------------	------	-----------	--------



Aspiratore assiale da incasso ad espulsione diretta.
Fascetta fornita di serie
Consumo W 15 - V240
Pressione statica mm. 3H2O,
Ingombro Ø 100 x 106 mm,
Made in Italy

VAR055

1

€ 43,12

	Descrizione	Art.	Ø tubo	Min. Ord.	Prezzo
--	-------------	------	--------	-----------	--------



Aspiratore da parete assiale. in materiale termoplastico, fissaggio a muro mediante tasselli in dotazione;
Consumo W 15 - V240,
Portata m3/h 85,
Pressione statica mm. 3H2O

VAR056

80 mm

3

€ 36,40

VAR057

100 mm

3

€ 37,75

VAR058

120 mm

3

€ 42,45

	Descrizione	Art.	Ø tubo	Min. Ord.	Prezzo
--	-------------	------	--------	-----------	--------



Aspiratore da parete ad aspirazione assiale.
Fissaggio a muro mediante tasselli in dotazione.
Consumo W 15 - V240,
Portata m3/h 110,
Pressione statica mm. 5H2O,
Apertura e chiusura automatica;
Sensore di umidità regolabile (min. 10% - max 90%)

VAR059

100 mm

3

€ 107,60

VAR060

120 mm

3

€ 119,02

ASPIRAZIONE / VENTILAZIONE

	Descrizione	Art.	Ø tubo	Min. Ord.	Prezzo
	Aspiratore da parete ad aspirazione assiale. Fissaggio a muro mediante tasselli in dotazione. Consumo W 15 - V240, Portata m3/h 100, Pressione statica mm. 4H2O, Apertura e chiusura automatica; Timer regolabile (min.5-max30 minuti)	VAR061	100 mm	3	€ 104,24
		VAR062	120 mm	3	€ 106,93

	Descrizione	Art.	Ø tubo	Min. Ord.	Prezzo
	Aspiratore da parete personalizzabile ad aspirazione assiale. Fissaggio a muro mediante tasselli in dotazione. Consumo W 15 - V240, Portata m3/h 100, Pressione statica mm. 4H2O, Apertura e chiusura automatica, Personalizzabile	VAR063	100 mm	3	€ 96,28

	Descrizione	Art.	Ø tubo	Min. Ord.	Prezzo
	Aspiratore da parete centrifugo. Fissaggio a muro mediante tasselli in dotazione. Consumo W 7 - V240, Portata m3/h 130, Pressione statica mm. 14H2o, Pressione Pa 137, Apertura e chiusura automatica	VAR064	80/90/100 mm	3	€ 163,45







ASPIRAZIONE / VENTILAZIONE

	Descrizione	Art.	Ø tubo	Min. Ord.	Prezzo
	Griglia pieghevole antisfondamento in Termoflex, bianca, con molle e rete	VAR065	da 80 a 100 mm	3	€ 7,66
		VAR066	da 100 a 125 mm	3	€ 10,31
		VAR067	da 125 a 160 mm	3	€ 12,19
		VAR068	da 160 a 200 mm	3	€ 16,66

	Descrizione	Art.	Ø tubo	Min. Ord.	Prezzo
	Griglia pieghevole antisfondamento in Termoflex, ramata, con molle e rete	VAR069	da 80 a 100 mm	3	€ 8,73
		VAR070	da 100 a 125 mm	3	€ 11,28
		VAR071	da 125 a 160 mm	3	€ 13,33

	Descrizione	Art.	Ø tubo	Min. Ord.	Prezzo
	Griglia pieghevole rettangolare antisfondamento in Termoflex con molle e rete	VAR072	da 100 a 160 mm	3	€ 13,43
		VAR073	da 160 a 200 mm	3	€ 19,08
		VAR074	160 mm fissaggio viti	3	€ 10,98
		VAR075	200 mm fissaggio viti	3	€ 14,94

CONSUMO

	Descrizione	Art.	Ø x mm	Min. Ord.	Prezzo
	Tagliatubi mini per rame da Ø 3 a Ø 22 mm	VAR004	3-22	1	€ 6,72
	Calibratore per tubi multistrato	VAR005	16-20-26	3	€ 11,42
	Cesoia per taglio tubi multistrato e polietilene	VAR006	da 16-32	3	€ 10,31
	Alesatore per interni ed esterni per tubi max 40 mm	VAR007	max 40	3	€ 8,83
	Verghe in stagno lega saldante	VAR008	100	3	€ 8,93
	Pasta a saldare	VAR009	130	3	€ 9,97
	Pasta autodecapante flussante con pennello	VAR010	100	3	€ 17,33

COLLANE

	Descrizione	Art.	Pollici	Ø	Min. Ord.	Prezzo
 <p>Collane in metallo con gomma</p> <p>IMPIEGO Per le installazioni negli impianti civili e industriali, per montaggio verticale o orizzontale. Adatto per tutti i tipi di tubi, applicazione a parete o a soffitto.</p>		VAR037	1/2"	20-25	3	€ 0,71
		VAR038	3/4"	26-30	3	€ 0,74
		VAR039	1"	32-36	3	€ 0,77
		VAR040	1-1/4"	38-43	3	€ 0,84
		VAR041	1-1/2"	47-51	3	€ 0,87
		VAR042	2"	60-64	3	€ 1,01
		VAR043	2-1/2"	75-80	3	€ 1,28
		VAR044	3"	87-92	3	€ 1,34
		VAR045	4"	113-118	3	€ 2,15

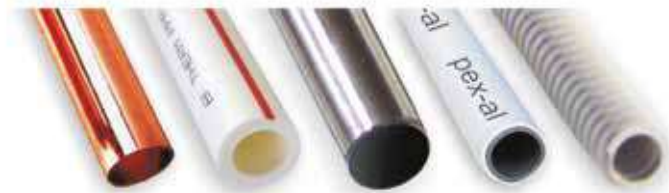

MANOMETRI E PRESSOSTATI

	Descrizione	Art.			Min. Ord.	Prezzo
	Cassa e quadrante: ABS Classe: 1,6 Prodotto conforme: UNI-EN 837-1 Temperatura di esercizio: -20°C / +80°C	VAR035	Manometro	0-10bar	3	€ 5,37
		VAR050	Niplo	1/2"-3/8"	3	€ 1,51
		VAR051	Termomanometro radiale	0-6bar/120°C	3	€ 10,83

	Descrizione	Art.		Min. Ord.	Prezzo
	Pressostato				
	Campo di regolazione: 1-5 bar Taratura di fabbrica: 1,4 - 2,8 bar Corrente nominale: 16A Tensione nominale: 250V	VAR036		3	€ 8,06

