

PROFESSIONALITA' E QUALITA'



EVOKlima™

TECNOLOGIA - BENESSERE - RISPETTO PER L'AMBIENTE

Edizione

1°

2025

www.evoklima.it

Smart Ingress
Ingresso intelligente



GUIDA AI PRODOTTI

WATER IS LIFE - L'ACQUA È VITA

L'IDRAULICA LA NOSTRA PASSIONE - HYDRAULICS OUR PASSION



A series of horizontal grey lines for writing, spanning the width of the page.



IL NOSTRO MIX VINCENTE

Passione, esperienza e professionalità determinano da sempre il successo della C.S.R. Con il brand "EvoKlima" l'azienda si vuole affermare tra le più grandi realtà del Sud Italia, e vuole essere un riferimento importante nei settori: Condizionamento, Termoidraulica, Rubinetteria, Elettropompe, Mobili da Bagno, Lavanderia, Caldaie, Stufe, ecc. ecc.



Passion



Experience



Development

I NOSTRI SERVIZI

Dalle soluzioni più semplici ai sistemi più avanzati, vi aiuteremo nella scelta dei materiali giusti per le vostre esigenze. Grazie a un aggiornamento continuo, puntiamo costantemente a offrirvi la migliore qualità disponibile sul mercato, selezionando marchi innovativi e all'avanguardia. Contatta il nostro personale.



I valori in cui crediamo. Con lo sguardo rivolto costantemente verso nuovi traguardi, vogliamo crescere fondando il nostro lavoro su valori come la fiducia, il rispetto e la cooperazione fra tutti i nostri collaboratori.



Tempestività ed efficienza
Attraverso una piattaforma logistica super assortita, garantiamo ogni giorno un servizio tempestivo ed efficiente con consegna rapida entro le 24/48 ore.



Il capitale umano
Crediamo fortemente nel nostro team, in continua espansione. La dedizione e le competenze di ognuno rappresentano una risorsa fondamentale per un servizio di qualità.



Al vostro servizio
Una rete ben strutturata di agenti saprà rispondere a tutte le vostre esigenze. Dotati di moderne tecnologie, sono continuamente aggiornati sulle disponibilità di un magazzino che conta ben oltre 18000 referenze.



Scarica il foglio Excel Commissione
Metodo veloce per effettuare un ordine ed essere aggiornato sui prezzi e disponibilità settimanalmente



Scarica il Catalistino Sfogliabile con i prezzi sempre aggiornati settimanalmente



Nel cuore della Sicilia, nella città di Agrigento, conosciuta in tutto il mondo per i suoi Templi e la Famosa scala dei Turchi sorge la Dielle del Gruppo C.S.R. s.r.l. una struttura che si estende su oltre 5.000 mq. dove risiede il cuore pulsante della EVOKLIMA diventato un Brand Importante per tutti i Siciliani. Il Brand Creato per essere un riferimento di servizi e possibilità di integrazione territoriali, con queste credenziali la C.S.R. srl si sente onorata nel proseguo di questo progetto. "Un Grazie Speciale Ai Creatori Della EVOKLIMA".



C.S.R. srlu

Deposito Agrigento "EVOKLIMA"

C/da San Benedetto Zona Industriale ASI

Aragona Tel. 0922 1801565



Responsabile Magazzino Alessio Conti
(il servizio è disponibile h24)

Lun./Ven. 8:30/13:00 -15:00/19:00

Sabato 8:30/13:00

Tel. & whatsapp: 091 2765973

Email: edrcsr@gmail.com

Il Nostro deposito Agrigento



Sala Meeting - Uffici



La nostra crescita si fonda sul rispetto e la fiducia di tutti i nostri collaboratori che danno ogni giorno un grande valore al nostro lavoro.



GLI ORDINI

Tutto il nostro personale è attento a gestire in poco tempo i vostri ordini con precisione e puntualità.

Il servizio di consegna è svolto da mezzi propri in maniera tempestiva e affidabile.

CONSEGNE IN 24/48 H



PANORAMICA DEPOSITO AGRIGENTO
ZONA INDUSTRIALE ASI CONTRADA SAN BENEDETTO ARAGONA



Legenda Sintesi Raccordi Polietilene ottone

Codice	Descrizione	Ø	Codice	Descrizione	Codice	Descrizione	Codice	Descrizione	Codice	Descrizione
NM20PB	Nipples Maschio	20	NF20PB	Nipples Femmina	GF20PB	Gomito Femmina	T20PB	Tee 3 lati	TF20PB	Tee f. 1/2"X20
NM25PB	Nipples Maschio	25	NF25PB	Nipples Femmina	GF25PB	Gomito Femmina	T25PB	Tee 3 lati	TF25PB	Tee f. 3/4"X25
NM32PB	Nipples Maschio	32	NF32PB	Nipples Femmina	GF32PB	Gomito Femmina	T32PB	Tee 3 lati	TF32PB	Tee f. 1"X32
NM40PB	Nipples Maschio	40	NF40PB	Nipples Femmina	GF40PB	Gomito Femmina	T40PB	Tee 3 lati	TF40PB	Tee f. 1 1/4"X40
NM50PB	Nipples Maschio	50	NF50PB	Nipples Femmina	GF50PB	Gomito Femmina	T50PB	Tee 3 lati	TF50PB	Tee f. 1 1/2"X50
NM63PB	Nipples Maschio	63	NF63PB	Nipples Femmina	GF63PB	Gomito Femmina	T63PB	Tee 3 lati	TF63PB	Tee f. 2"X63

Legenda Sintesi Raccordi Polietilene Plastica

D.	C.	Ø	Codice	Descrizione	Codice Finale	Codice	Descrizione	Codice Finale	Codice	Descrizione	Codice Finale	Codi.	Codice Finale
1/2"	D	20	330-	Nipplo Maschio	330-D20	330A	Nipplo Femmina	330A-D20	331-	Nipplo Doppio	331-20	332-	332-20
3/4"	G	25	330-	Nipplo Maschio	330-G25	330A	Nipplo Femmina	330A-G25	331-	Nipplo Doppio	331-25	332-	332-25
1"	H	32	330-	Nipplo Maschio	330-H32	330A	Nipplo Femmina	330A-H32	331-	Nipplo Doppio	331-32	332-	332-32
1 1/4"	HB	40	330-	Nipplo Maschio	330-HB40	330A	Nipplo Femmina	330A-HB40	331-	Nipplo Doppio	331-40	332-	332-40
1 1/2"	HD	50	330-	Nipplo Maschio	330-HD50	330A	Nipplo Femmina	330A-HD50	331-	Nipplo Doppio	331-50	332-	332-50
2"	OL	63	330-	Nipplo Maschio	330-OL63	330A	Nipplo Femmina	330A-OL63	331-	Nipplo Doppio	331-63	332-	332-63
2 1/2"	OLD	75	330-	Nipplo Maschio	330-OLD75	330A	Nipplo Femmina	330A-OLD75	331-	Nipplo Doppio	331-75	332-	332-75
3"	Y	90	330-	Nipplo Maschio	330-Y90	330A	Nipplo Femmina	330A-Y90	331-	Nipplo Doppio	331-90	332-	332-90
4"	Z	110	330-	Nipplo Maschio	330-Z110	330A	Nipplo Femmina	330A-Z110	331-	Nipplo Doppio	331-110	332-	332-110

Legenda Sintesi Raccordi Ottone Giallo Lettera indicativa "G"; Per i Raccordi Cromati la lettera indicativa sarà "C"; Per la raccorderia Zincata la lettera indicativa sarà "Z"; Sul foglio ordine attenzionare lo slesc nel codice articolo \ e non /

Codice	Descrizione	Ø	Codice	Descrizione	Codice	Descrizione	Codice	Descrizione	Codice	Descrizione
GZ3\8	Gomito Zincato FF	3/8"	GZ3\8MF	Gomito Zincato FF	TZ3\8	Tee ZINCATO FFF	NZ3\8	NIPLES ZINCATO	MZ3\8	MAMICOTTO ZINCATO
GZ1\2	Gomito Zincato FF	1/2"	GZ1\2MF	Gomito Zincato FF	TZ1\2	Tee ZINCATO FFF	NZ1\2	NIPLES ZINCATO	MZ1\2	MAMICOTTO ZINCATO
GZ3\4	Gomito Zincato FF	3/4"	GZ3\4MF	Gomito Zincato FF	TZ3\4	Tee ZINCATO FFF	NZ3\4	NIPLES ZINCATO	MZ3\4	MAMICOTTO ZINCATO
GZ1	Gomito Zincato FF	1"	GZ1MF	Gomito Zincato FF	TZ1	Tee ZINCATO FFF	NZ1	NIPLES ZINCATO	MZ1	MAMICOTTO ZINCATO
GZ11\4	Gomito Zincato FF	1 1/4"	GZ11\4MF	Gomito Zincato FF	TZ11\4	Tee ZINCATO FFF	NZ11\4	NIPLES ZINCATO	MZ11\4	MAMICOTTO ZINCATO
GZ11\2	Gomito Zincato FF	1 1/2"	GZ11\2MF	Gomito Zincato FF	TZ11\2	Tee ZINCATO FFF	NZ11\2	NIPLES ZINCATO	MZ11\2	MAMICOTTO ZINCATO
GZ2	Gomito Zincato FF	2"	GZ2MF	Gomito Zincato FF	TZ2	Tee ZINCATO FFF	NZ2	NIPLES ZINCATO	MZ2	MAMICOTTO ZINCATO
GZ21\2	Gomito Zincato FF	2 1/2"	GZ21\2MF	Gomito Zincato FF	TZ3	Tee ZINCATO FFF	NZ3	NIPLES ZINCATO	MZ3	MAMICOTTO ZINCATO
GZ3	Gomito Zincato FF	3"	GZ3MF	Gomito Zincato FF	TZ4	Tee ZINCATO FFF	NZ4	NIPLES ZINCATO	MZ4	MAMICOTTO ZINCATO
GZ4	Gomito Zincato FF	4"	GZ4MF	Gomito Zincato FF	TZ5	Tee ZINCATO FFF	NZ5	NIPLES ZINCATO	MZ5	MAMICOTTO ZINCATO

Legenda Colori Guarnizioni

D.	C.	Codice	Descrizione	Codice Finale
1/4"	B	2100ESE	Guarnizione Esente	2100ESE0B
3/8"	C	2100ESE	Guarnizione Esente	2100ESE0C
1/2"	D	2100ESE	Guarnizione Esente	2100ESE0D
3/4"	G	2100ESE	Guarnizione Esente	2100ESE0G
1"	H	2100ESE	Guarnizione Esente	2100ESE0H
1 1/4"	HB	2100ESE	Guarnizione Esente	2100ESEHB
1 1/2"	HD	2100ESE	Guarnizione Esente	2100ESEHD
2"	OL	2100ESE	Guarnizione Esente	2100ESEOL
2 1/2"	OLD	2100ESE	Guarnizione Esente	2100ESEOLD
3"	OY	2100ESE	Guarnizione Esente	2100ESE0Y
4"	OZ	2100ESE	Guarnizione Esente	2100ESE0Z

Legenda Raccordi e Tubi Pvc

D.	C.	Descrizione	Codice Finale	C.	Descrizione	Codice Finale
32	CC	Curva Chiusa	CC32	CA	Curva Aperta	CA32
40	CC	Curva Chiusa	CC40	CA	Curva Aperta	CA40
50	CC	Curva Chiusa	CC50	CA	Curva Aperta	CA50
63	CC	Curva Chiusa	CC63	CA	Curva Aperta	CA63
80	CC	Curva Chiusa	CC80	CA	Curva Aperta	CA80
100	CC	Curva Chiusa	CC100	CA	Curva Aperta	CA100
125	CC	Curva Chiusa	CC125	CA	Curva Aperta	CA125
140	CC	Curva Chiusa	CC140	CA	Curva Aperta	CA140
160	CC	Curva Chiusa	CC160	CA	Curva Aperta	CA160
200	CC	Curva Chiusa	CC200	CA	Curva Aperta	CA200

Legenda Colori Rubinetti











I.	Colore	I.	Colore
00	Cromato	80	Granito Bianco
04	Bianco	81	Granito Nero
		82	Granito Rosa
		83	Granito Pietro
		84	Granito Grigio
47	Bronzato	85	Granito Avena
65	Rame		
100	Terra Francia		

Legenda Raccordi e Tubi Pvc

D.	C.	Descrizione	Codice Finale	C.	Descrizione	Codice Finale
32	BV	Braga a V	BV32	BT	Braga a T	BT32
40	BV	Braga a V	BV40	BT	Braga a T	BT40
50	BV	Braga a V	BV50	BT	Braga a T	BT50
63	BV	Braga a V	BV63	BT	Braga a T	BT63
80	BV	Braga a V	BV80	BT	Braga a T	BT80
100	BV	Braga a V	BV100	BT	Braga a T	BT100
125	BV	Braga a V	BV125	BT	Braga a T	BT125
140	BV	Braga a V	BV140	BT	Braga a T	BT140
160	BV	Braga a V	BV160	BT	Braga a T	BT160
200	BV	Braga a V	BV200	BT	Braga a T	BT200



Scarica la promo attraverso il codice QR

			Presscontrol   PROMO	pressostato Square D   PROMO		Energie Rinnovabili   PROMO			
Staffe Clima   PROMO	Rame Clima   PROMO	Igienizzante Inox   PROMO	Trattamento Aria   PROMO		Contatori   PROMO	xylem   PROMO	Staffa lavabo   PROMO	Staffa lavabo   PROMO	Staffa lavabo   PROMO
					Eco Pucci   PROMO	Placche Eco   PROMO		Sanitari Civita   PROMO	
			Rame Clima   Scopri di più	Riscaldamento-Solare   Scopri di più				Piatti Doccia   Scopri di più	Sanitari   Scopri di più
Tubi Pvc   PROMO	Cavidotto-Polietilene   PROMO	Tube Multistrato   PROMO	Lowara   PROMO						

F.C. DISTRIBUTION™

Elettrodomestici Incasso   PROMO	Elettrodomestici Libera   PROMO	Trevidea    PROMO	Vinco-Hunday   PROMO	Omac   PROMO	Latte Olio   PROMO		Stefanplast   PROMO	Plasticoforte   PROMO
---	--	--	---	---	---	--	--	--



Categoria	Pagina		Figura
Tubi Pvc - Pozzetti	Da 11	A 17	
Tubi Pvc ad Innesto	Da 18	A 19	
Tubo Polililene & Cavidotto	Da 20	A 20	
Raccordi Polililene	Da 20	A 23	
Raccordi Polipropilene	Da 24	A 25	
Raccordi Ottone Giallo	Da 27	A 29	
Raccordi Ottone cromo	Da 30	A 31	
Raccordi Zincati	Da 32	A 35	
Raccordi riparazione & Presa acqua			
Valvole a sfera	Da 37	A 39	
Gas: Valvole - Raccordi - Regolatori	Da 40	A 43	
Rame per Acqua & Riscaldamento	Da 44	A 45	
Rame Clima			
Tubo Multistrato & Raccordi Cassetta Collettori	Da 48	A 53	
Elettropompe Arven	Da 59	A 61	
Elettropompe Lowara	Da 62	A 63	
Elettropompe Calpeda			
Accessori Autoclave	Da 64	A 72	
Trattamento acque			
Serbatoi Acqua per Alimenti	Da 73	A 76	
Scaldabagni & Accessori	Da 78	A 79	
Radiatori & Termoarredi	Da 80	A 81	
Accesori Riscaldamento	Da 82	A 86	
Fumisteria	Da 87	A 92	
Solare & Fotovoltaico	Da 93	A 97	

Categoria	Pagina		Figura
Impianti a Pavimenti	Da 98	A 101	
Bollitori - Volani Termici	Da 102	A 103	
Climatizzatori Accessori	Da 104	A 107	
Pompe di calore Idronico	Da 108	A 110	
Rubinerie	Da 111	A 117	
Rubinerie cucina	Da 118	A 126	
Minuterie Rubinerie	Da 126	A 133	
Flessibili & Antivibranti	Da 135	A 140	
Minuterie idrauliche	Da 141	A 145	
Guarnizioni - lavatrice			
Sifoni & Accessori	Da 146	A 156	
Docce & Saliscendi	Da 157	A 164	
Copriwater	Da 169	A 187	
Cassette Zaino - Alte	Da 188	A 193	
Accessori & Ricambi			
Cassette Pucciplast	Da 194	A 215	
Accessori & Ricambi			
Cassette Grohe	Da 216	A 218	
Accessori & Ricambi			
Mobili Bagno	Da 219	A 223	
Lavanderia	Da 224	A 227	
Lavelli Kit Elettrodomestici	Da 228	A 229	
Box Doccia	Da 230	A 232	
Sanitari Civile	Da 233	A 248	
Sanitari Comunità			
Piatti Doccia	Da 259	A 262	
Piccoli Elettrodomestici	Da 282	A 284	
Riscaldamento - Ventilazione			
Ferramenta & Attrezzatura	Da 263	A 281	
Elettricità	Da 284	A 290	



PVC tubi

PROMO

Tubo 1 mt



Tubo 2 mt



Tubo 3 mt



Codice	Rif.	Listino A	Listino B	Codice	Rif.	Listino A	Listino B	Codice	Rif.	Listino A	Listino B
T32X1	32x1	3,01 €	3,34 €	T32X2	32x2	5,18 €	5,75 €	T32X3	32x3	6,21 €	6,90 €
T40X1	40x1	3,01 €	3,34 €	T40X2	40x2	5,18 €	5,75 €	T40X3	40x3	6,21 €	6,90 €
T50X1	50x1	3,84 €	4,27 €	T50X2	50x2	6,58 €	7,31 €	T50X3	50x3	7,92 €	8,79 €
T63X1	63x1	4,88 €	5,41 €	T63X2	63x2	8,42 €	9,34 €	T63X3	63x3	10,09 €	11,20 €
T80X1	80x1	5,65 €	6,27 €	T80X2	80x2	9,72 €	10,79 €	T80X3	80x3	11,69 €	12,98 €
T100X1	100x1	5,98 €	6,64 €	T100X2	100x2	10,32 €	11,46 €	T100X3	100x3	12,36 €	13,72 €
T125X1	125x1	8,22 €	9,12 €	T125X2	125x2	14,16 €	15,72 €	T125X3	125x3	17,03 €	18,91 €
T140X1	140x1	9,89 €	10,97 €	T140X2	140x2	17,03 €	18,91 €	T140X3	140x3	20,44 €	22,69 €
T160X1	160x1	11,76 €	13,05 €	T160X2	160x2	20,31 €	22,54 €	T160X3	160x3	24,35 €	27,03 €
T200X1	200x1	16,63 €	18,46 €	T200X2	200x2	28,63 €	31,78 €	T200X3	200x3	34,37 €	38,15 €

Raccordi in PVC



Curva Chiusa solo a Confezione



Curva Aperta solo a Confezione



Braga a "V" solo a Confezione

Codice	Rif.	Listino A	Listino B	Codice	Rif.	Listino A	Listino B	Codice	Rif.	Listino A	Listino B
CC32	D. 32	0,49 €	0,54 €	CA32	D. 32	0,40 €	0,45 €	BV32	D. 32	0,73 €	0,81 €
CC40	D. 40	0,57 €	0,63 €	CA40	D. 40	0,49 €	0,54 €	BV40	D. 40	0,81 €	0,90 €
CC50	D. 50	0,81 €	0,90 €	CA50	D. 50	0,73 €	0,81 €	BV50	D. 50	1,05 €	1,17 €
CC63	D. 63	1,21 €	1,35 €	CA63	D. 63	1,13 €	1,26 €	BV63	D. 63	2,02 €	2,25 €
CC80	D. 80	1,54 €	1,71 €	CA80	D. 80	1,38 €	1,53 €	BV80	D. 80	2,91 €	3,24 €
CC100	D. 100	1,90 €	2,11 €	CA100	D. 100	1,69 €	1,88 €	BV100	D. 100	3,24 €	3,59 €
CC125	D. 125	2,83 €	3,15 €	CA125	D. 125	2,43 €	2,70 €	BV125	D. 125	5,67 €	6,29 €
CC140	D. 140	4,45 €	4,94 €	CA140	D. 140	3,64 €	4,04 €	BV140	D. 140	7,69 €	8,54 €
CC160	D. 160	5,26 €	5,84 €	CA160	D. 160	4,86 €	5,39 €	BV160	D. 160	9,72 €	10,78 €
CC200	D. 200	9,72 €	10,78 €	CA200	D. 200	8,10 €	8,99 €	BV200	D. 200	17,81 €	19,77 €



Braga a "T" Ridotta



Braga a "V" Ridotta



Braga a "T" solo a Confezione

Codice	Rif.	Listino A	Listino B	Codice	Rif.	Listino A	Listino B	Codice	Rif.	Listino A	Listino B
BTR100X40	100x40	2,83 €	3,14 €	BVR100X40	100x40	2,83 €	3,14 €	BT32	D. 32	0,73 €	0,81 €
BTR100X50	100x50	2,83 €	3,14 €	BVR100X50	100x50	3,08 €	3,41 €	BT40	D. 40	0,81 €	0,90 €
BTR100X63	100x63	3,08 €	3,41 €	BVR100X63	100x63	3,24 €	3,59 €	BT50	D. 50	1,05 €	1,17 €
BTR100X80	100x80	3,08 €	3,41 €	BVR100X80	100x80	3,08 €	3,41 €	BT63	D. 63	2,02 €	2,25 €
BTR125X40	125x40	6,48 €	7,19 €	BVR125X40	125x40	6,48 €	7,19 €	BT80	D. 80	2,91 €	3,24 €
BTR125X50	125x50	6,48 €	7,19 €	BVR125X50	125x50	6,48 €	7,19 €	BT100	D. 100	3,24 €	3,59 €
BTR125X63	125x63	6,48 €	7,19 €	BVR125X63	125x63	6,48 €	7,19 €	BT125	D. 125	5,67 €	6,29 €
BTR125X80	125x80	6,48 €	7,19 €	BVR125X80	125x80	6,48 €	7,19 €	BT140	D. 140	7,69 €	8,54 €
BTR125X100	125x100	6,48 €	7,19 €	BVR125X100	125x100	6,48 €	7,19 €	BT160	D. 160	9,72 €	10,78 €
								BT200	D. 200	17,81 €	19,77 €



Riduzione FM

Codice	Rif.	Listino A	Listino B
R40X32	40x32	0,49 €	0,54 €
R50X40	50x40	0,65 €	0,72 €
R63X40	63x40	0,69 €	0,76 €
R80X63	80x63	0,97 €	1,08 €
R80X40	80x40	0,97 €	1,08 €
R100X80	100x80	1,21 €	1,35 €
R100X63	100x63	1,21 €	1,35 €
R100X40	100x40	1,21 €	1,35 €
R125X100	125x100	2,02 €	2,25 €
R140X100	140x100	2,83 €	3,15 €
R140X125	140x125	2,83 €	3,15 €
R160X140	160x140	3,64 €	4,04 €
R200X160	200x160	5,67 €	6,29 €



Aumento MF

Codice	Rif.	Listino A	Listino B
A32X40	40x32	0,40 €	0,45 €
A40X50	50x40	0,65 €	0,72 €
A40X63	63x40	0,69 €	0,76 €
A40X80	80x40	0,97 €	1,08 €
A40X100	100x40	1,21 €	1,35 €
A63X80	80x63	0,97 €	1,08 €
A63X100	100x63	1,21 €	1,35 €
A80X100	100x80	1,21 €	1,35 €
A100X125	125x100	2,02 €	2,25 €
A100X140	140x100	2,83 €	3,15 €
A125X140	140x125	2,83 €	3,15 €
A140X160	160x140	3,64 €	4,04 €
A160X200	200x160	5,67 €	6,29 €



Manicotto Pvc Con Fermo D. 32 MFS32

Codice	Rif.	Listino A	Listino B
MFS32	32	1,60 €	1,78 €
MFS40	40	3,56 €	3,95 €



Manicotto Pvc Scorrevole D. 80 MS80

Codice	Rif.	Listino A	Listino B
MS80	D. 80	4,09 €	4,54 €
MS100	D. 100	4,45 €	4,94 €
MS125	D. 125	5,34 €	5,92 €



Sifone O-O

Codice	Rif.	Listino A	Listino B
SOO100	D. 100	12,14 €	13,48 €
SOO125	D. 125	17,79 €	19,74 €



Sifone Verticale

Codice	Rif.	Listino A	Listino B
SVO100	D. 100	16,19 €	17,97 €
SVO125	D. 125	22,23 €	24,68 €



Sifone a Colonna

Codice	Rif.	Listino A	Listino B
SVM80	D. 80	18,72 €	20,78 €
SVM100	D. 100	22,72 €	25,22 €
SVM125	D. 125	31,63 €	35,11 €



Sifone Roma Da 100 Pvc SR100

Codice	Rif.	Listino A	Listino B
SR100	D. 100	27,57 €	30,60 €
SR80	D. 80	27,21 €	30,21 €



Sifone Vv Da 100 Monolitico SVV100

Codice	Rif.	Listino A	Listino B
SVV100	D. 100	23,12 €	25,67 €



Giunto Riparazione

Codice	Rif.	Listino A	Listino B
GR100	D. 100	5,67 €	6,29 €
GR125	D. 125	8,91 €	9,89 €



Valvola Antiriflusso

Codice	Rif.	Listino A	Listino B
VA100	D. 100	66,70 €	74,04 €
VA125	D. 125	75,60 €	83,91 €
VA140	D. 140	80,04 €	88,85 €
VA160	D. 160	124,51 €	138,21 €
VA200	D. 200	142,30 €	157,95 €



Bocchettone Terrazzo PVC

Codice	Rif.	Listino A	Listino B
BPA100	D. 100	8,82 €	9,79 €
BPA125	D. 125	18,28 €	20,29 €
BP100	D. 100	8,82 €	9,79 €
BP125	D. 125	9,80 €	10,88 €



Giunto scorrevole

Codice	Rif.	Listino A	Listino B
GS80	D. 80	5,67 €	6,29 €
GS100	D. 100	6,48 €	7,19 €
GS125	D. 125	9,72 €	10,78 €



Curva 90°Ispezione Testa D.100 CSTV87100

Codice	Rif.	Listino A	Listino B
CSTV87100	D. 100	14,40 €	15,99 €

CSTVS



Curva Chiusa 90° C/Ispezione Sx

Codice	Rif.	Listino A	Listino B
CSTVS87100	D. 100	16,97 €	18,84 €
CSTVS87125	D. 125	19,33 €	21,46 €
CSTVS87140	D. 140	Arrivo	Arrivo
CSTVS87160	D. 160	33,39 €	37,07 €
CSTVS87200	D. 200	Arrivo	Arrivo

CSTVD



Curva Chiusa 90° C/Ispezione Dx

Codice	Rif.	Listino A	Listino B
CSTVD87100	D. 100	14,40 €	15,99 €
CSTVD87125	D. 125	19,33 €	21,46 €
CSTVD87140	D. 140	Arrivo	Arrivo
CSTVD87160	D. 160	33,39 €	37,07 €
CSTVD87200	D. 200	Arrivo	Arrivo



Derivazione A Tee 87°30' Con Tappo Di Ispezione Da 100 DTIS100

Codice	Rif.	Listino A	Listino B
DTIS100	D. 100	5,69 €	6,32 €

CSTVD



Curva Aperta 45°C/Ispezione Dx

Codice	Rif.	Listino A	Listino B
CSTVD45100	D. 100	14,04 €	15,58 €
CSTVD45125	D. 125	18,41 €	20,44 €
CSTVD45140	D. 140	23,34 €	25,91 €
CSTVD45160	D. 160	28,69 €	31,85 €
CSTVD45200	D. 200	Arrivo	Arrivo

CSTVS



Curva Aperta 45°C/Ispezione Sx

Codice	Rif.	Listino A	Listino B
CSTVS45100	D. 100	14,04 €	15,58 €
CSTVS45125	D. 125	18,41 €	20,44 €
CSTVS45140	D. 140	23,34 €	25,91 €
CSTVS45160	D. 160	28,69 €	31,85 €
CSTVS45200	D. 200	Arrivo	Arrivo



Braga 87° A Croce Da 100 BC100

Codice	Rif.	Listino A	Listino B
BC100	D. 100	20,30 €	22,53 €

DSTVD



Derivazione A Vee 45° Con Tappo Di Ispezione

Codice	Rif.	Listino A	Listino B
DSTVD45100	D. 100	14,04 €	15,58 €
DSTVD45125	D. 125	18,41 €	20,44 €

DSTVS



Derivazione A Vee 45° Con Tappo Di Ispezione

Codice	Rif.	Listino A	Listino B
DSTVS45100	D. 100	14,04 €	15,58 €
DSTVS45125	D. 125	18,41 €	20,44 €

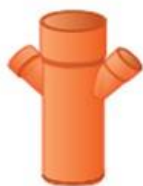

Braga A Vee Rid. 40X100X40

Codic	Rif.	List	List
BVR40X100X40	D. 100	6,88 €	7,64 €



Derivazione A Vee 45° Ridotta 100 X 40 X 40

Codice	Rif.	Listino A	Listino B
DR2V10040	D. 100	5,13 €	5,70 €



Derivazione A Vee 45° Ridotta 100X40X40X40

Codice	Rif.	Listino A	Listino B
DR3V10040	D. 100	9,17 €	10,17 €



Derivazione Ridotta 87° D.100 Angolo 1+1+1 Da 40

Codic	Rif.	List	List
DR3T10040	D. 100	6,55 €	7,27 €



Derivazione Ridotta 87° D.100 Angolo 1+1 Da 40

Codice	Rif.	Listino A	Listino B
DR2T10040	D. 100	5,13 €	5,70 €



Derivazione A V 45° Ridotta 1000 X 40X40X40X40

Codice	Rif.	Listino A	Listino B
DR4V10040	D. 100	10,48 €	11,63 €

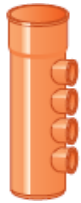

Derivazione Ridotta 87° D.100 Angolo 1+1+1 Da 40 DR4T10040

Codic	Rif.	List	List
DR4T10040	D. 100	9,17 €	10,17 €



Derivazione Ridotta 87° D.100 Angolo 1+1 Da 40 DR2TS10040

Codice	Rif.	Listino A	Listino B
DR2TS10040	D. 100	5,13 €	5,70 €



Derivazione Ridotta 87° D.100 Angolo 2+2 Da 40 DR4TS10040

Codice	Rif.	Listino A	Listino B
DR4TS10040	D. 100	9,17 €	10,17 €



Curva 90° Wc Uscita 100 Pvc Arancio CWC

Codic	Rif.	List	List
CWC		3,11 €	3,45 €



Curva 100 Wc Uscita 40 Dx CWC40D

Codice	Rif.	Listino A	Listino B
CWC40D		4,05 €	4,49 €
CWC40S		4,05 €	4,49 €



Curva Wc Laterale 2 Uscite 40 CWC2L40

Codice	Rif.	Listino A	Listino B
CWC2L40		4,45 €	4,94 €



Tappo a Vite

Codice	Rif.	Listino A	Listino B
TV32	D. 32	2,54 €	2,81 €
TV40	D. 40	0,81 €	0,90 €
TV50	D. 50	1,21 €	1,35 €
TV63	D. 63	1,62 €	1,80 €
TV80	D. 80	2,02 €	2,25 €
TV100	D. 100	2,43 €	2,70 €
TV125	D. 125	3,24 €	3,59 €
TV140	D. 140	4,05 €	4,49 €
TV160	D. 160	5,67 €	6,29 €
TV200	D. 200	7,29 €	8,09 €



Tappo con foro

Codice	Rif.	Listino A	Listino B
T40X32	40x32	0,40 €	0,45 €
T50X40	50x40	0,65 €	0,72 €
T63X40	63x40	1,72 €	1,91 €
T80X40	80x40	2,01 €	2,23 €
T100X40	100x40	1,62 €	1,80 €
T125X100	125x100	3,40 €	3,78 €
T125X40	125x40	3,40 €	3,78 €
T100X32X32	100x32x32	2,33 €	2,58 €
T100X40X32	100x40x32	2,33 €	2,58 €
T100X40X40	100x40x40	1,62 €	1,80 €



Braga a "V" Doppia

Codice	Rif.	Listino A	Listino B
BVD100	D. 100	9,72 €	10,78 €
BVD125	D. 125	14,57 €	16,18 €



Guarnizione tappo a vite

Codice	Rif.	Listino A	Listino B
GTV100	D. 100	0,81 €	0,90 €
GTV125	D. 125	0,97 €	1,08 €



Tappo Cieco

Codice	Rif.	Listino A	Listino B
TFS32	32x1	0,56 €	0,62 €
TFS40	40x1	0,27 €	0,30 €
TFS50	50x1	0,36 €	0,39 €



Curva Ridotta Mf Arancio

Codice	Rif.	Listino A	Listino B
CR40X32MF	40x32	2,33 €	2,59 €
CR50X40MF	50x40	2,28 €	2,53 €



Braga a "V" Scagno

Codice	Rif.	Listino A	Listino B
BVS100	D. 100	18,31 €	20,32 €
BVS125	D. 125	27,33 €	30,33 €



Tappo con tre fori 100-40-40-40

Codice	Rif.	Listino A	Listino B
TA100TF40	D. 100	3,54 €	3,93 €



Parafoglie Nero Da 60<>125 PF60-125

Codice	Rif.	Listino A	Listino B
PF60-125		0,96 €	1,07 €



Raccogliore in PVC per pluviali

Codice	Rif.	Listino A	Listino B
RCC080100		26,92 €	29,88 €
RCC110125		38,46 €	42,69 €



REDI
le strade dell'acqua

Curva Chiusa Redi

Codice	Rif.	Listino A	Listino B
CC32R	D. 32	1,04 €	1,15 €
CC40R	D. 40	0,77 €	0,86 €
CC50R	D. 50	1,31 €	1,45 €
CC63R	D. 63	1,62 €	1,80 €
CC80R	D. 80	1,86 €	2,06 €
CC100R	D. 100	2,42 €	2,68 €
CC125R	D. 125	5,51 €	6,11 €
CC140R	D. 140	8,06 €	8,95 €
CC160R	D. 160	11,76 €	13,05 €
CC200R	D. 200	21,10 €	23,42 €



REDI
le strade dell'acqua

Curva Aperta Redi

Codice	Rif.	Listino A	Listino B
CA32R	D. 32	1,14 €	1,26 €
CA40R	D. 40	0,84 €	0,93 €
CA50R	D. 50	1,09 €	1,21 €
CA63R	D. 63	1,31 €	1,45 €
CA80R	D. 80	1,71 €	1,90 €
CA100R	D. 100	2,10 €	2,33 €
CA125R	D. 125	3,88 €	4,31 €
CA140R	D. 140	5,29 €	5,87 €
CA160R	D. 160	7,97 €	8,84 €
CA200R	D. 200	14,10 €	15,65 €



REDI
le strade dell'acqua

Braga a "V" Redi

Codice	Rif.	Listino A	Listino B
BV32R	D. 32	1,69 €	1,87 €
BV40R	D. 40	1,69 €	1,87 €
BV50R	D. 50	1,82 €	2,02 €
BV63R	D. 63	2,37 €	2,63 €
BV80R	D. 80	3,60 €	4,00 €
BV100R	D. 100	9,19 €	10,20 €
BV125R	D. 125	9,19 €	10,20 €
BV140R	D. 140	11,92 €	13,23 €
BV160R	D. 160	17,09 €	18,97 €
BV200R	D. 200	31,97 €	35,49 €



REDI
le strade dell'acqua

Riduzione Redi FM

Codice	Rif.	Listino A	Listino B
R40X32R	40x32	1,73 €	1,93 €
R50X40R	50x40	2,51 €	2,78 €
R63X40R	63x40	2,51 €	2,78 €
R80X63R	80x63	3,40 €	3,77 €
R80X40R	80x40	3,40 €	3,77 €
R100X80R	100x80	4,57 €	5,07 €
R100X63R	100x63	4,57 €	5,07 €
R100X40R	100x40	4,57 €	5,07 €
R125X100R	125x100	6,10 €	6,77 €
R140X100R	140x100	7,55 €	8,38 €
R140X125R	140x125	7,55 €	8,38 €
R160X140R	160x140	7,55 €	8,38 €
R200X160R	200x160	17,49 €	19,41 €



REDI
le strade dell'acqua

Aumento Redi MF

Codice	Rif.	Listino A	Listino B
A32X40R	40x32	2,51 €	2,78 €
A40X50R	50x40	2,51 €	2,78 €
A40X63R	63x40	3,21 €	3,56 €
A40X80R	80x40	3,40 €	3,77 €
A40X100R	100x40	4,57 €	5,07 €
A63X80R	80x63	3,40 €	3,77 €
A63X100R	100x63	4,57 €	5,07 €
A80X100R	100x80	4,57 €	5,07 €
A100X125R	125x100	5,34 €	5,93 €
A100X140R	140x100	7,55 €	8,38 €
A125X140R	140x125	7,55 €	8,38 €
A140X160R	160x140	10,35 €	11,49 €
A160X200R	200x160	17,49 €	19,41 €



REDI
le strade dell'acqua

Braga a "T" Redi

Codice	Rif.	Listino A	Listino B
BT32R	D. 32	1,69 €	1,87 €
BT40R	D. 40	1,69 €	1,87 €
BT50R	D. 50	1,82 €	2,02 €
BT63R	D. 63	2,37 €	2,63 €
BT80R	D. 80	3,60 €	4,00 €
BT100R	D. 100	4,48 €	4,98 €
BT125R	D. 125	9,02 €	10,02 €
BT140R	D. 140	11,92 €	13,23 €
BT160R	D. 160	17,78 €	19,73 €
BT200R	D. 200	31,97 €	35,49 €



REDI
le strade dell'acqua

Tappo a Vite Redi

Codice	Rif.	Listino A	Listino B
TV32R	D. 32	2,54 €	2,81 €
TV40R	D. 40	2,54 €	2,81 €
TV50R	D. 50	2,46 €	2,73 €
TV63R	D. 63	3,81 €	4,23 €
TV80R	D. 80	3,81 €	4,23 €
TV100R	D. 100	5,33 €	5,92 €



REDI
le strade dell'acqua

Sifone Verticale Redi

Codice	Rif.	Listino A	Listino B
SVO100R	D. 100	30,55 €	33,92 €
SVO125R	D. 125	35,63 €	39,55 €



REDI
le strade dell'acqua

Sifone O-O Redi

Codice	Rif.	Listino A	Listino B
SOO100R	D. 100	26,72 €	29,66 €
SOO125R	D. 125	35,63 €	39,55 €



Pozzetto con coperchio 20x20

Codice	Rif.	Listino A	Listino B
PUC20PP	20x20	4,39 €	4,87 €
Pozzetto con coperchio 30x30			
Codice	Rif.	Listino A	Listino B
PUC30PP	30x30	10,63 €	11,80 €
Pozzetto con coperchio 40x40			
Codice	Rif.	Listino A	Listino B
PUC40PP	40x40	21,76 €	24,15 €



Telaio & Coperchio con Chiusino

Codice	Rif.	Listino A	Listino B
TC30S	30x30	13,76 €	15,28 €
TC40S	40x40	21,51 €	23,87 €
TC55S	55x55	77,42 €	85,94 €



Collare per Pluviale

Codice	Rif.	Listino A	Listino B
CL32	D. 32	0,55 €	0,61 €
CL40	D. 40	0,76 €	0,84 €
CL50	D. 50	0,70 €	0,77 €
CL60	D. 63	0,84 €	0,93 €
CL80	D. 80	0,84 €	0,93 €
CL100	D. 100	0,87 €	0,97 €
CL125	D. 125	0,96 €	1,06 €
CL140	D. 140	0,89 €	0,98 €
CL160	D. 160	0,96 €	1,07 €
CL200	D. 200	4,07 €	4,52 €



Telaio Con Coperchio



Telaio & Coperchio con griglia

Codice	Rif.	Listino A	Listino B
UTC20PP	200X200	3,44 €	3,82 €
UTC30PP	300X300	6,88 €	7,64 €
UTC40PP	400X400	13,76 €	15,28 €
UTC55PP	550X550	32,69 €	36,29 €



Chiusino orientabile sifonato angolare in PP con scarico laterale e griglia inox 120x250x180

Codice	Rif.	Listino A	Listino B
CHLANG50NX		32,39 €	35,95 €



Colla Riempitiva PantaKol



Chiusino orientabile sifonato in PP grigio con scarico laterale



Chiusino Laterale

Codice	Rif.	Listino A	Listino B
BCRP	gr. 500	9,87 €	10,96 €



Chiusino orientabile sifonato PP grigio scarico laterale e griglia inox



Chiusino orientabile ribassato in PP grigio con scarico laterale



Colla Riempitiva PantaKol

Codice	Rif.	Listino A	Listino B
TCRP	gr. 125	3,29 €	3,65 €
TCRPX200	200	3,10 €	3,44 €
TCRPX500	500	2,85 €	3,16 €



Chiusino orientabile sifonato in PP grigio con scarico laterale e piletta inox a vite 150x150



Chiusino sifonato in PP grigio con scarico verticale interno



Valvola Antiriflusso Bianca 40X40

Codice	Rif.	Listino A	Listino B
0750AR64B0	40x40	12,07 €	13,40 €
0750AR54B0	32x32	12,95 €	14,38 €

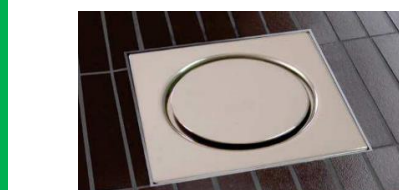

Codice	Rif.	Listino A	Listino B
CHL15065NXV		28,34 €	31,46 €

Codice	Rif.	Listino A	Listino B
CS10PP	10	0,81 €	0,90 €
CS15PP	15	1,62 €	1,80 €
CS20PP	20	3,24 €	3,60 €



Tubo in PP 2 Bicchiere

Codice	Riferimenti	Pz	Listino A	Listino B
VS0501201	cm. 50D. 32	1	2,65 €	2,94 €
VS0501203	MT. 1,00D. 32	1	3,48 €	3,87 €
VS0501205	MT. 2,00D. 32	1	6,41 €	7,12 €
VS0501207	MT. 3,00D. 32	1	8,73 €	9,69 €
VS0501213	cm. 50D. 40	1	2,12 €	2,35 €
VS0501215	MT. 1,00D. 40	1	3,12 €	3,46 €
VS0501217	MT. 2,00D. 40	1	5,48 €	6,08 €
VS0501219	MT. 3,00D. 40	1	8,22 €	9,13 €
VS0501225	cm. 50D. 50	1	2,65 €	2,94 €
VS0501227	MT. 1,00D. 50	1	3,81 €	4,23 €
VS0501229	MT. 2,00D. 50	1	7,29 €	8,10 €
VS0501231	MT. 3,00D. 50	1	10,87 €	12,07 €
VS0501281	cm. 50D. 90	1	6,60 €	7,32 €
VS0501283	MT. 1,00D. 90	1	9,85 €	10,93 €
VS0501285	MT. 2,00D. 90	1	17,47 €	19,39 €
VS0501287	MT. 3,00D. 90	1	26,11 €	28,98 €
VS0501249	cm. 50D. 110	1	7,90 €	8,77 €
VS0501251	MT. 1,00D. 110	1	11,23 €	12,47 €
VS0501253	MT. 2,00D. 110	1	20,81 €	23,10 €
VS0501255	MT. 3,00D. 110	1	30,10 €	33,41 €



Tubo in PP 1 Bicchiere

Codice	Riferimenti	Pz	Listino A	Listino B
VS0501005	cm. 50D. 32	1	1,90 €	2,11 €
VS0501009	MT. 1,00D. 32	1	3,02 €	3,35 €
VS0501013	MT. 2,00D. 32	1	5,67 €	6,29 €
VS0501015	MT. 3,00D. 32	1	8,36 €	9,28 €
VS0501025	cm. 50D. 40	1	1,75 €	1,94 €
VS0501029	MT. 1,00D. 40	1	2,67 €	2,96 €
VS0501033	MT. 2,00D. 40	1	5,16 €	5,72 €
VS0501035	MT. 3,00D. 40	1	7,57 €	8,40 €
VS0501045	cm. 50D. 50	1	2,12 €	2,35 €
VS0501049	MT. 1,00D. 50	1	3,39 €	3,76 €
VS0501053	MT. 2,00D. 50	1	6,50 €	7,22 €
VS0501055	MT. 3,00D. 50	1	9,48 €	10,52 €
VS0501145	cm. 50 D. 90	1	5,39 €	5,98 €
VS0501149	MT. 1,00D. 90	1	8,64 €	9,59 €
VS0501153	MT. 2,00D. 90	1	16,45 €	18,26 €
VS0501155	MT. 3,00D. 90	1	24,99 €	27,74 €
VS0501085	cm. 50D. 110	1	6,13 €	6,81 €
VS0501089	MT. 1,00D. 110	1	9,48 €	10,52 €
VS0501093	MT. 2,00D. 110	1	18,39 €	20,42 €
VS0501095	MT. 3,00D. 110	1	27,87 €	30,94 €



Braga Semplice a 45° in PP

Codice	Riferimenti	Pz	Listino A	Listino B
VS0508001	D. 32	1	2,18 €	2,42 €
VS0508007	D. 40	1	1,60 €	1,77 €
VS0508013	D. 50	1	2,02 €	2,25 €
VS0599061	D. 90	1	5,48 €	6,08 €
VS0508025	D. 110	1	5,39 €	5,98 €



Braga Semplice a 90° in PP

Codice	Riferimenti	Pz	Listino A	Listino B
VS0508005	D. 32	1	2,23 €	2,48 €
VS0508011	D. 40	1	1,60 €	1,77 €
VS0508017	D. 50	1	2,09 €	2,32 €
VS0599065	D. 90	1	5,48 €	6,08 €
VS0508029	D. 110	1	5,39 €	5,98 €



Curva MF a 90° in PP

Codice	Riferimenti	Pz	Listino A	Listino B
VS0504011	D. 32	1	0,93 €	1,03 €
VS0504023	D. 40	1	0,82 €	0,91 €
VS0504035	D. 50	1	1,07 €	1,19 €
VS0599051	D. 90	1	2,79 €	3,09 €
VS0504059	D. 110	1	3,34 €	3,71 €



Curva MF a 45° in PP

Codice	Riferimenti	Pz	Listino A	Listino B
VS0504005	D. 32	1	0,93 €	1,03 €
VS0504017	D. 40	1	0,82 €	0,91 €
VS0504029	D. 50	1	1,03 €	1,15 €
VS0599045	D. 90	1	2,79 €	3,09 €
VS0504053	D. 110	1	3,30 €	3,66 €



Braga Rid.Pp Htea D.90/40
90° VS0599075



Braga Rid.Pp Htea D.40/32
45° VS0510001

Codice	Riferimenti	PZ	Listino A	Listino B
VS0599075	D.90/40	1	3,63 €	4,03 €
VS0599077	D.90/50	1	5,47 €	6,07 €
VS0510029	D.110/40	1	3,74 €	4,16 €
VS0510035	D.110/50	1	3,67 €	4,07 €

Codice	Riferimenti	PZ	Listino A	Listino B
VS0510001	D.40/32	1	2,40 €	2,66 €
VS0599071	D.90/40	1	3,78 €	4,20 €
VS0599073	D.90/50	1	3,92 €	4,35 €
VS0510025	D.110/40	1	3,69 €	4,10 €
VS0599089	D.110/90	1	10,02 €	11,12 €
VS0510031	D.110/50	1	3,64 €	4,04 €



Pp Braga Doppia 110-110- 110-
67



Pp Braga Doppia 90-90-90- 87'

Codice	Riferimenti	PZ	Listino A	Listino B
BDA111167	110-110-110	1	15,79 €	17,53 €

Codice	Riferimenti	PZ	Listino A	Listino B
BDA090987	90-90-90	1	14,40 €	15,98 €



Sella Dm.100/40 Pvc Grigio



Pvc Curva Ridotta 110-100- 87'

Codice	Riferimenti	PZ	Listino A	Listino B
SL104	100X40	1	5,55 €	6,16 €

Codice	Riferimenti	PZ	Listino A	Listino B
BPV111087	110-110	1	8,45 €	9,38 €



Curve Tecniche ad incollaggio



Riduzione Ecc.Pp Htr D.
40/32



Codice	Riferimenti	PZ	Listino A	Listino B
CR40X32FF	D. 40 F x 32 F	1	1,52 €	1,69 €
CR40X32FM	D. 40 F x 32 M	1	Arrivo	Arrivo
C40FF	D. 40 F x 40 F	1	1,86 €	2,06 €

Codice	Riferimenti	PZ	Listino A	Listino B
VS0514001	A. . 40-32	1	1,37 €	1,53 €
VS0514002	A. . 50-32	1	1,61 €	1,78 €
VS0514003	A. . 50-40	1	0,94 €	1,04 €



Tronchetto per collegamento
Pvc



Pp Curva Wc Prolung Dn 110-
90'

Codice	Riferimenti	PZ	Listino A	Listino B
VS0530001	D.40	1	3,34 €	3,71 €
VS0530003	D.50	1	3,81 €	4,23 €
VS0599121	D.90	1	8,60 €	9,55 €
VS0530007	D.110	1	7,06 €	7,84 €

Codice	Riferimenti	PZ	Listino A	Listino B
BSBPR0090	110-90°	1	9,48 €	10,52 €
BSBPR0990	90°-90°	1	8,83 €	9,80 €



Pvc-Pp Racc Passagg Dn 100-110



SIGILL GITANG PLUS TUBETTO
IN ASTUCCIO 125 gr. 0002036

Codice	Riferimenti	PZ	Listino A	Listino B
BPV100110	110-110	1	5,11 €	5,67 €

Codice	Riferimenti	PZ	Listino A	Listino B
0002036		1	4,43 €	4,92 €

Politilene Pn 25 Ad Pe100 Sdr
7,4



PROMO

Codice	Riferimenti	Mt	Listino A	Listino B
PN2025	D. 20-1/2"	200	1,87 €	2,08 €
PN2525	D. 25-3/4"	200	2,76 €	3,06 €
PN3225	D. 32-1"	200	3,09 €	3,43 €
PN4025	D. 40-11/4	100	4,83 €	5,36 €
PN5025	D. 50-11/2	100	7,53 €	8,36 €
PN6325	D. 63-2	50	12,63 €	14,01 €

Politilene Pe100 Pn 16 Sdr11



PROMO

Codice	Riferimenti	Mt	Listino A	Listino B
PN2016	D. 20-1/2"	200	1,45 €	1,61 €
PN2516	D. 25-3/4"	200	1,42 €	1,58 €
PN3216	D. 32-1"	200	2,21 €	2,45 €
PN4016	D. 40-11/4	100	4,13 €	4,59 €
PN5016	D. 50-11/2	100	5,30 €	5,89 €
PN6316	D. 63-2	50	9,97 €	11,06 €

Politilene Bassa Densità Peld
D20 Pn10 PN2010



PROMO

Codice	Riferimenti	Mt	Listino A	Listino B
PN2010	D. 20-1/2"	200	1,35 €	1,49 €
PN2510	D. 25-3/4"	200	1,97 €	2,19 €
PN3210	D. 32-1"	200	3,21 €	3,57 €
PN4010	D. 40-11/4	100	4,94 €	5,49 €
PN5010	D. 50-11/2	100	7,77 €	8,62 €
PN6310	D. 63-2	50	12,32 €	13,67 €

Politilene Irrigazione Pn 6 Bd



PROMO

Codice	Riferimenti	Mt	Listino A	Listino B
P620	D. 20-1/2"	200	0,95 €	1,05 €
P625	D. 25-3/4"	200	1,41 €	1,56 €
P632	D. 32-1"	200	2,30 €	2,55 €
P640	D. 40-11/4	100	3,52 €	3,91 €
P650	D. 50-11/2	100	5,36 €	5,94 €
P663	D. 63-2	50	8,43 €	9,36 €

Politilene Riplast Bassa
Densità

Linea Agricoltura Pn 10 D. 20
P20



PROMO

Codice	Riferimenti	Mt	Listino A	Listino B
P20	D. 20-1/2"	200	0,73 €	0,81 €
P25	D. 25-3/4"	200	1,14 €	1,26 €
P32	D. 32-1"	200	1,85 €	2,05 €
P40	D. 40-11/4"	100	2,45 €	2,72 €
P50	D. 50-11/2	100	3,93 €	4,36 €
P63	D. 63-2	50	6,51 €	7,22 €

Tubi Corrugati In Hpde



PROMO

Codice	Riferimenti	Mt	Listino A	Listino B
CAV40	D. 40	200	1,62 €	1,80 €
CAV50	D. 50	200	1,95 €	2,16 €
CAV63	D. 63	200	2,40 €	2,67 €

Politilene Gas S5 D. 20 Ad
Pe100 P20G

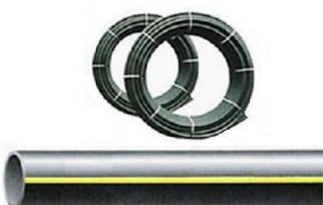

PROMO

Codice	Riferimenti	Mt	Listino A	Listino B
P20G	D. 20-1/2"	200	1,41 €	1,56 €
P25G	D. 25-3/4"	200	2,01 €	2,23 €
P32G	D. 32-1"	200	2,64 €	2,93 €
P40G	D. 40-11/4	100	3,57 €	3,96 €
P50G	D. 50-11/2	100	5,64 €	6,26 €
P63G	D. 63-2	50	8,87 €	9,85 €

HD-PE100 IMPACT PN25-
SDR 7,4 Tubo in rotoli per acqua. Per
il coinvolgimento in pressione di
acqua potabile e per applicazioni
industriali



PROMO

Codice	Riferimenti	Mt	Listino A	Listino B
PI2025	D. 20-1/2"	200	1,44 €	1,60 €
PI2525	D. 25-3/4"	200	2,12 €	2,36 €
PI3225	D. 32-1"	200	3,31 €	3,67 €
PI4025	D. 40-11/4	100	5,16 €	5,73 €
PI5025	D. 50-11/2	100	8,05 €	8,94 €
PI6325	D. 63-2	50	12,62 €	14,01 €



Nipples Maschio Politilene
D. 1/2" X 20 NM20PB

Codice	Riferimenti	Pz	Listino A	Listino B
NM20PB	1/2"x20	1	2,26 €	2,51 €
NM25PB	3/4"x25	1	3,66 €	4,06 €
NM32PB	1"x32	1	6,25 €	6,94 €
NM40PB	1 1/4"x40	1	10,03 €	11,13 €
NM50PB	1 1/2"x50	1	14,27 €	15,84 €
NM63PB	2"x63	1	22,72 €	25,22 €



Niples Femmina Politilene
D. 1/2" X 20 NF20PB

Codice	Riferimenti	Pz	Listino A	Listino B
NF20PB	1/2"x20	1	2,41 €	2,67 €
NF25PB	3/4"x25	1	3,54 €	3,93 €
NF32PB	1"x32	1	5,89 €	6,54 €
NF40PB	1 1/4"x40	1	9,82 €	10,90 €
NF50PB	1 1/2"x50	1	14,42 €	16,01 €
NF63PB	2"x63	1	22,16 €	24,60 €



Nipples Doppio Politilene
D. 20 N20PB

Codice	Riferimenti	Pz	Listino A	Listino B
N20PB	20x20	1	3,66 €	4,06 €
N25PB	25x25	1	5,55 €	6,16 €
N32PB	32x32	1	9,35 €	10,38 €
N40PB	40x40	1	14,73 €	16,35 €
N50PB	50x50	1	25,46 €	28,26 €
N63PB	63x63	1	35,52 €	39,42 €



Gomito Doppio 20
Politilene G20PB

Codice	Riferimenti	Pz	Listino A	Listino B
G20PB	20x20	1	5,01 €	5,56 €
G25PB	25x25	1	7,21 €	8,00 €
G32PB	32x32	1	16,61 €	18,44 €
G40PB	40x40	1	17,33 €	19,24 €
G50PB	50x50	1	29,76 €	33,03 €
G63PB	63x63	1	47,73 €	52,98 €



Gomito Femmina Politilene
D. 1/2" X 20 GF20PB

Codice	Riferimenti	Pz	Listino A	Listino B
GF20PB	1/2"x20	1	3,26 €	3,62 €
GF25PB	3/4"x25	1	5,23 €	5,80 €
GF32PB	1"x32	1	7,72 €	8,56 €
GF40PB	1 1/4"x40	1	13,82 €	15,34 €
GF50PB	1 1/2"x50	1	23,37 €	25,94 €
GF63PB	2"x63	1	38,12 €	42,32 €



Gomito Maschio Politilene
D. 1/2" X 20 GM20PB

Codice	Riferimenti	Pz	Listino A	Listino B
GM20PB	1/2"x20	1	3,30 €	3,66 €
GM25PB	3/4"x25	1	5,16 €	5,73 €
GM32PB	1"x32	1	10,09 €	11,20 €
GM40PB	1 1/4"x40	1	14,97 €	16,61 €
GM50PB	1 1/2"x50	1	23,32 €	25,88 €
GM63PB	2"x63	1	36,73 €	40,77 €



Tee Politilene 3 Lati D. 20
T20PB

Codice	Riferimenti	Pz	Listino A	Listino B
T20PB	20x20	1	6,89 €	7,65 €
T25PB	25x25	1	8,89 €	9,86 €
T32PB	32x32	1	15,91 €	17,66 €
T40PB	40x40	1	24,60 €	27,30 €
T50PB	50x50	1	37,95 €	42,13 €
T63PB	63x63	1	57,04 €	63,31 €



Tees Femmina Politilene
D. 1/2" X 20 TF20PB

Codice	Riferimenti	Pz	Listino A	Listino B
TF20PB	1/2"x20	1	4,90 €	5,43 €
TF25PB	3/4"x25	1	7,30 €	8,11 €
TF32PB	1"x32	1	11,92 €	13,23 €
TF40PB	1 1/4"x40	1	19,73 €	21,90 €
TF50PB	50x50	1	31,10 €	34,52 €
TF63PB	63x63	1	47,74 €	52,99 €



Gomito Femmina Flangiato
Politilene

Codice	Riferimenti	Pz	Listino A	Listino B
GFL20PB	1/2"x20	1	4,42 €	4,90 €
GFL25PB	3/4"x25	1	7,00 €	7,77 €



Anima Rinforzo
Politilene

Codice	Riferimenti	Pz	Listino A	Listino B
A20PB	1/2"x20	1	1,11 €	1,23 €
A25PB	3/4"x25	1	1,58 €	1,76 €
A32PB	1"x32	1	3,12 €	3,46 €
A40PB	1 1/4"x40	1	3,38 €	3,75 €



Raccordo Compressione M
20X3/4" 330-G20

Codice	Riferimenti	Listino A	Listino B	Off.	Box
330-G20	20x3/4"	0,82 €	0,91 €	1	12
330-G25	25x3/4"	1,05 €	1,17 €	1	12
330-H32	32x1"	1,08 €	1,20 €	1	12
330-HB40	40x11/4"	2,54 €	2,82 €	1	12
330-HD50	50x11/2"	3,09 €	3,44 €	1	12
330-OL63	2"	4,09 €	4,54 €	1	12



Gomito Doppio 90° 25X25
332-25

Codice	Riferimenti	Listino A	Listino B	Off.	Box
332-20	D. 20	1,49 €	1,66 €	1	12
332-25	D. 25	1,62 €	1,79 €	1	12
332-32	D. 32	3,54 €	3,93 €	1	12
332-40	D. 40	4,61 €	5,11 €	1	12
332-50	D. 50	8,53 €	9,46 €	1	12
332-63	D. 63	7,51 €	8,34 €	1	12



Tee 90° F 25X3/4" 333-G25

Codice	Riferimenti	Listino A	Listino B	Off.	Box
333-D20	20x1/2"	1,47 €	1,63 €	1	12
333-G25	25x3/4"	1,88 €	2,09 €	1	12
333-H32	32x1"	2,96 €	3,29 €	1	12
333-HB40	40x11/4"	5,44 €	6,04 €	1	12
333-HD50	11/2"x50	6,48 €	7,19 €	1	12
333-OL63	2"x63	10,17 €	11,29 €	1	12



Gomito 90° Maschio
3/4"X25 332A-G25

Codice	Riferimenti	Listino A	Listino B	Off.	Box
332A-D20	1/2"x20	1,06 €	1,18 €	1	12
332A-G25	3/4"x25	1,29 €	1,43 €	1	12
332A-H32	1"x32	1,59 €	1,77 €	1	12
332A-HB40	11/4"x40	2,66 €	2,95 €	1	12
332A-HD50	11/2"x50	3,69 €	4,10 €	1	12
332A-OL63	2"x63	4,88 €	5,42 €	1	12



Gomito Flangia 3/4"X25
332D-G25

Codice	Riferimenti	Listino A	Listino B	Off.	Box
332D-D20	1/2"x20	3,01 €	3,34 €	1	12
332D-G25	3/4"x25	3,01 €	3,34 €	1	12



Raccordo Compressione F
20X1/2" 330A-D20

Codice	Riferimenti	Listino A	Listino B	Off.	Box
330A-D20	20x3/4"	1,59 €	1,77 €	1	12
330A-G25	25x3/4"	1,22 €	1,35 €	1	12
330A-H32	32x1"	1,23 €	1,37 €	1	12
330A-HB40	40x11/4"	2,24 €	2,49 €	1	12
330A-HD50	50x11/2"	3,51 €	3,89 €	1	12
330A-OL63	2"	4,09 €	4,54 €	1	12



Nipples Doppio 25X25 331-25

Codice	Riferimenti	Listino A	Listino B	Off.	Box
331-20	D. 20	1,32 €	1,47 €	1	12
331-25	D. 25	1,53 €	1,70 €	1	12
331-32	D. 32	1,96 €	2,17 €	1	12
331-40	D. 40	4,22 €	4,69 €	1	12
331-50	D. 50	4,81 €	5,34 €	1	12
331-63	D. 63	6,68 €	7,42 €	1	12



Tee 90° Tre Lati D. 25 334-25

Codice	Riferimenti	Listino A	Listino B	Off.	Box
334-20	D. 20	1,73 €	1,92 €	1	12
334-25	D. 25	2,30 €	2,55 €	1	12
334-32	D. 32	2,98 €	3,31 €	1	12
334-40	D. 40	5,19 €	5,76 €	1	12
334-50	D. 50	7,11 €	7,90 €	1	12
334-63	D. 63	10,10 €	11,21 €	1	12



Gomito Politilene F.
3/4"X25 332B-G25

Codice	Riferimenti	Listino A	Listino B	Off.	Box
332B-D20	1/2"x20	1,14 €	1,26 €	1	12
332B-G25	3/4"x25	1,25 €	1,38 €	1	12
332B-H32	1"x32	1,55 €	1,72 €	1	12
332B-HB40	11/4"x40	3,08 €	3,42 €	1	12
332B-HD50	11/2"x50	4,09 €	4,54 €	1	12
332B-OL63	2"x63	5,62 €	6,24 €	1	12



Tee 90° M 25X3/4" 333A-G25

Codice	Riferimenti	Listino A	Listino B	Off.	Box
333A-D20	1/2"x20	1,62 €	1,80 €	1	12
333A-G25	3/4"x25	2,05 €	2,27 €	1	12
333A-H32	1"x32	4,20 €	4,66 €	1	12
333A-HB40	11/4"x40	4,63 €	5,14 €	1	12
333A-HD50	11/2"x50	6,27 €	6,97 €	1	12
333A-OL63	2"x63	10,02 €	11,12 €	1	12

Art. 420

Tappo Calotta Femmina D.
3/4" 420-G

Codice	Riferimenti	Listino A	Listino B	Off.	Box
420-D	1/2"x20	0,18 €	0,20 €	1	12
420-G	3/4"x25	0,23 €	0,26 €	1	12
420-H	1"x32	0,34 €	0,37 €	1	12
420-HB	1 1/4"x40	0,55 €	0,61 €	1	12
420-HD	1 1/2"x50	0,81 €	0,90 €	1	12
420-OL	2"x63	1,01 €	1,12 €	1	12

Art. 460



Gomito Ff 90° D. 3/4" 460-G

Codice	Riferimenti	Listino A	Listino B	Off.	Box
460-D	1/2"x20	0,94 €	1,04 €	1	12
460-G	3/4"x25	1,10 €	1,22 €	1	12
460-H	1"x32	1,23 €	1,37 €	1	12
460-HB	1 1/4"x40	2,10 €	2,34 €	1	12
460-HD	1 1/2"x50	3,28 €	3,65 €	1	12
460-OL	2"x63	4,68 €	5,19 €	1	12

Art. 470



Tee Fff 90° D. 3/4" 470-G

Codice	Riferimenti	Listino A	Listino B	Off.	Box
470-D	1/2"x20	1,23 €	1,37 €	1	12
470-G	3/4"x25	1,51 €	1,68 €	1	12
470-H	1"x32	1,64 €	1,82 €	1	12
470-HB	1 1/4"x40	2,84 €	3,15 €	1	12
470-HD	1 1/2"x50	4,23 €	4,70 €	1	12
470-OL	2"x63	6,63 €	7,36 €	1	12

Art. 440



Manicotto Pvc Ff D. 3/4" 440-G

Codice	Riferimenti	Listino A	Listino B	Off.	Box
440-D	1/2"x20	0,49 €	0,55 €	1	12
440-G	3/4"x25	0,53 €	0,59 €	1	12
440-H	1"x32	0,66 €	0,73 €	1	12
440-HB	1 1/4"x40	1,49 €	1,65 €	1	12
440-HD	1 1/2"x50	2,17 €	2,41 €	1	12
440-OL	2"x63	2,60 €	2,89 €	1	12

Art. 400



Niplo Pvc D. 1" 400-H

Codice	Riferimenti	Listino A	Listino B	Off.	Box
400-D	1/2"x20	0,19 €	0,21 €	10	120
400-G	3/4"x25	0,22 €	0,25 €	10	120
400-H	1"x32	0,33 €	0,36 €	5	60
400-HB	1 1/4"x40	0,57 €	0,64 €	5	40
400-HD	1 1/2"x50	0,78 €	0,87 €	5	40
400-OL	2"x63	1,23 €	1,37 €	5	20

Art. 430



Tappo Maschio Pvc D. 3/4" 430-G

Codice	Riferimenti	Listino A	Listino B	Off.	Box
430-D	1/2"x20	0,22 €	0,25 €	1	12
430-G	3/4"x25	0,31 €	0,34 €	1	12
430-H	1"x32	0,32 €	0,35 €	1	12
430-HB	1 1/4"x40	0,51 €	0,56 €	1	12
430-HD	1 1/2"x50	0,90 €	1,00 €	1	12
430-OL	2"x63	1,10 €	1,22 €	1	12

Art. 500



Gomito 90° Mf D. 3/4" 500-G

Codice	Riferimenti	Listino A	Listino B	Off.	Box
500-D	1/2"x20	0,81 €	0,90 €	1	12
500-G	3/4"x25	0,86 €	0,95 €	1	12
500-H	1"x32	1,04 €	1,15 €	1	12

Art. VJB

Valvola A Sfera Pn16 D.
3/4" PI VJB0202

Codice	Riferimenti	Listino A	Listino B	Off.	Box
VJB0152	1/2"x20	Arrivo	Arrivo	1	12
VJB0202	3/4"x25	2,28 €	2,53 €	1	12
VJB0252	1"x32	2,78 €	3,09 €	1	12
VJB0322	1 1/4"x40	5,06 €	5,62 €	1	12
VJB0402	1 1/2"x50	7,59 €	8,43 €	1	12
VJB0502	2"x63	11,64 €	12,92 €	1	12

Art. 480



Riduzione Pvc Mf 1"X1/2" 480-HD

Codice	Riferimenti	Listino A	Listino B	Off.	Box
480-GD	3/4"X1/2"	0,43 €	0,48 €	1	12
480-HD	1"X1/2"	0,46 €	0,51 €	1	12
480-HG	1"X3/4"	0,47 €	0,52 €	1	12
480-HBD	1 1/4"X1/2"	0,69 €	0,77 €	1	12
480-HBG	1 1/4"X3/4"	0,69 €	0,77 €	1	12
480-HBH	1 1/4"X1"	0,78 €	0,87 €	1	12
480-HDG	1 1/2"X3/4"	1,22 €	1,35 €	1	12
480-HDH	1 1/2"X1"	1,22 €	1,35 €	1	12
480-HDHB	1 1/2"X1 1/4"	1,42 €	1,57 €	1	12
480-OLD	2"X1/2"	1,57 €	1,74 €	1	12
480-OLG	2"X3/4"	1,57 €	1,74 €	1	12
480-OLH	2"X1"	1,93 €	2,14 €	1	12
480-OLHB	2"X1 1/4"	3,97 €	4,41 €	1	12
480-OLHD	2"X1 1/2"	3,97 €	4,41 €	1	12
480-OLDOL	2 1/2"X2"	2,80 €	3,10 €	1	12
480-YOL	3"X2"	6,07 €	6,73 €	1	12
480-YOLD	3"X2 1/2"	6,07 €	6,73 €	1	12



Tubo Polipropilene 20X3,4
Fusiotherm Faser Sdr 6 / 7,4 S Zz
Barra 4 Mt Prezzo Metro
TA20X3,4

Codice	Riferimenti	Listino A	Listino B	Off.	Box
TA20X3,4	D.. 20	1,49 €	1,66 €	4	12
TA25X4,2	D.. 25	2,38 €	2,64 €	4	12
TA32X5,4	D.. 32	4,39 €	4,87 €	4	12
TA40X6,7	D.. 40	7,33 €	8,14 €	4	12



Tee Maschio Polipropilene
1/2X20 TMA1\2X20

Codice	Riferimenti	Listino A	Listino B	Off.	Box
TMA1\2X20	1/2"x20	4,87 €	5,41 €	1	12
TMA3\4X25	3/4"x25	6,63 €	7,36 €	1	12



Gomito Filettato Maschio
1/2"X20 GAM1\2X20

Codice	Riferimenti	Listino A	Listino B	Off.	Box
GAM1\2X20	1/2"x20	2,88 €	3,19 €	1	12
GAM3\4X20	3/4"x20	5,21 €	5,79 €	1	12
GAM1\2X25	1/2"X25	4,87 €	5,41 €	1	12
GAM3\4X25	3/4"X25	5,26 €	5,84 €	1	12
GAM3\4X32	3/4"X32	9,75 €	10,82 €	1	12
GAM1X32	1"X32	12,18 €	13,52 €	1	12



Gomito Fem. Polipropilene
1/2"X20 GFA1\2X20

Codice	Riferimenti	Listino A	Listino B	Off.	Box
GFA1\2X20	1/2"x20	2,96 €	3,29 €	1	12
GFA3\4X20	3/4"x20	3,66 €	4,06 €	1	12
GFA3\4X25	3/4"x25	4,39 €	4,87 €	1	12
GFA3\4X32	3/4"X32	5,65 €	6,28 €	1	12
GFA1X32	1"X32	9,75 €	10,82 €	1	12



Tee Femmina Polipropilene
1/2X20 TFA1\2X20

Codice	Riferimenti	Listino A	Listino B	Off.	Box
TFA1\2X20	1/2"x20	3,31 €	3,68 €	1	12
TFA3\4X25	3/4"x25	5,07 €	5,63 €	1	12
TFA3\4X32	3/4"X32	7,41 €	8,22 €	1	12
TFA1X32	1"X32	12,84 €	14,26 €	1	12



Raccordo Retto Con Dado
Girevole 3/4 F X 20
RRGA3\4X20

Codice	Riferimenti	Listino A	Listino B	Off.	Box
RRGA3\4X20	3/4"X20	10,23 €	11,36 €	1	12
RRGA1X32	1"X32	26,32 €	29,21 €	1	12
RRGA11\2X40	1"1/2X40	19,40 €	21,53 €	1	12
RRGA2X50	2"X50	43,22 €	47,98 €	1	12
RRGA21\2X63	21/2"X63	60,99 €	67,70 €	1	12



Niples Maschio Polipropilene
D.1/2"X20 NMA1\2X20

Codice	Riferimenti	Listino A	Listino B	Off.	Box
NMA1\2X20	1/2"x20	3,02 €	3,35 €	1	12
NMA1\2X25	1/2"x25	4,68 €	5,19 €	1	12
NMA3\4X20	3/4"x20	4,97 €	5,52 €	1	12
NMA3\4X25	3/4"x25	4,87 €	5,41 €	1	12
NMA11\4X40	11/4"x40	21,44 €	23,80 €	1	12
NMA11\2X50	11/2"x50	24,86 €	27,59 €	1	12
NMA2X63	2"x63	38,50 €	42,74 €	1	12



Niples Femmina Polipropilene
D.1/2"X20 NFA1\2X20

Codice	Riferimenti	Listino A	Listino B	Off.	Box
NFA1\2X20	1/2"x20	2,63 €	2,92 €	1	12
NFA1\2X25	1/2"x25	4,19 €	4,65 €	1	12
NFA3\4X20	3/4"x20	3,95 €	4,38 €	1	12
NFA3\4X25	3/4"x25	4,00 €	4,44 €	1	12
NFA11\4X40	11/4"x40	19,98 €	22,18 €	1	12
NFA11\2X50	11/2"x50	22,42 €	24,88 €	1	12
NFA2X63	2"x63	36,07 €	40,03 €	1	12



Manicotto Polipropilene Ff D. 32
MA32



Gomito Ff Polipropilene Da 32
GA32

Codice	Riferimenti	Listino A	Listino B	Off.	Box
MA20	20x20	0,33 €	0,37 €	1	12
MA25	25x25	0,50 €	0,55 €	1	12
MA32	32x32	0,73 €	0,81 €	1	12
MA40	40x40	1,80 €	2,00 €	1	12
MA50	50x50	2,58 €	2,87 €	1	12
MA63	63x63	5,82 €	6,46 €	1	12
MA75	75X75	10,54 €	11,69 €	1	12

Codice	Riferimenti	Listino A	Listino B	Off.	Box
GA20	20x20	0,44 €	0,49 €	1	12
GA25	25x25	0,58 €	0,64 €	1	12
GA32	32x32	0,88 €	0,97 €	1	12
GA40	40x40	2,10 €	2,33 €	1	12
GA50	50x50	4,00 €	4,44 €	1	12
GA63	63x63	8,98 €	9,97 €	1	12
GA75	75X75	14,48 €	16,07 €	1	12



Tee Polipropilene Da 32 TA32



Curva Aperta Polipropilene D.32
CAA32

Codice	Riferimenti	Listino A	Listino B	Off.	Box
TA20	20x20x20	0,50 €	0,55 €	1	12
TA25	25x25x25	0,58 €	0,64 €	1	12
TA32	32x32x32	0,96 €	1,06 €	1	12
TA40	40x40x40	2,24 €	2,49 €	1	12
TA50	50x50x50	4,78 €	5,30 €	1	12
TA63	63x63x63	9,79 €	10,87 €	1	12
TA75	75X75x75	22,92 €	25,44 €	1	12

Codice	Riferimenti	Listino A	Listino B	Off.	Box
CAA20	20x20	0,55 €	0,61 €	1	12
CAA25	25x25	0,79 €	0,88 €	1	12
CAA32	32x32	1,25 €	1,38 €	1	12
CAA40	40x40	2,05 €	2,27 €	1	12
CAA50	50x50	4,63 €	5,14 €	1	12
CAA63	63x63	7,70 €	8,55 €	1	12
CAA75	75X75	9,82 €	10,90 €	1	12



Riduzion Polipropilene 25X20 M
/F RA25X20



Sorpasso Sald. Polipropilene 20
SSA20

Codice	Riferimenti	Listino A	Listino B	Off.	Box
RA25X20	20x25	0,47 €	0,52 €	1	12
RA32X20	20x32	0,58 €	0,65 €	1	12
RA32X25	25x32	0,68 €	0,76 €	1	12
RA40X32	32x40	1,56 €	1,73 €	1	12
RA50X32	32x50	2,44 €	2,70 €	1	12
RA50X40	40x50	2,44 €	2,71 €	1	12
RA63X50	50x63	4,58 €	5,08 €	1	12
RA75X63	63x75	4,55 €	5,05 €	1	12

Codice	Riferimenti	Listino A	Listino B	Off.	Box
SSA20	20x20	2,07 €	2,29 €	1	12
SSA25	25x25	2,63 €	2,92 €	1	12



Gomit Flang. Polipropilene
1/2"X20 GFLA1\2X20

Codice	Riferimenti	Listino A	Listino B	Off.	Box
GFLA1\2X20	1/2"x20	2,92 €	3,25 €	1	12



Rubinetto A Sfera Con Maniglia
Dn 25 RIA25



Rubinetto D'Arresto A Vitone
Con Cappuccio D. 25 RCA25

Codice	Riferimenti	Listino A	Listino B	Off.	Box
RIA20	D.. 20x20	31,19 €	34,62 €	1	12
RIA25	D.. 25x25	32,17 €	35,70 €	1	12

Codice	Riferimenti	Listino A	Listino B	Off.	Box
RCA20	D.. 20x20	14,37 €	15,95 €	1	12
RCA25	D.. 25x25	16,62 €	18,45 €	1	12



Rubinetto D'Arresto A Vitone
Con Maniglia D 25 RIAP25



Rubinetto D'Arresto A Spera Con
Cappuccio D. 25 RICA25

Codice	Riferimenti	Listino A	Listino B	Off.	Box
RIAP20	D.. 20x20	21,02 €	23,33 €	1	12
RIAP25	D.. 25x25	24,29 €	26,96 €	1	12

Codice	Riferimenti	Listino A	Listino B	Off.	Box
RICA20	D.. 20x20	25,83 €	28,67 €	1	12
RICA25	D.. 25x25	27,78 €	30,84 €	1	12



Gomito Giallo Da 1/2" Ff GG1\2

Codice	Riferimenti	Listino A	Listino B	Off.	Box
GG1\4	1/4" FF	1,88 €	2,09 €	1	12
GG3\8	3/8" FF	1,65 €	1,83 €	1	12
GG1\2	1/2" FF	2,89 €	3,21 €	1	12
GG3\4	3/4" FF	3,67 €	4,07 €	1	12
GG1	1" FF	5,66 €	6,28 €	1	12
GG11\4	1"1/4 FF	7,45 €	8,27 €	1	12
GG11\2	1"1/2 FF	9,82 €	10,89 €	1	12
GG2	2" FF	16,28 €	18,08 €	1	12



Gomito Giallo Da 1/2" Mf GG1\2MF

Codice	Riferimenti	Listino A	Listino B	Off.	Box
GG1\4MF	1/4" MF	0,89 €	0,99 €	1	12
GG3\8MF	3/8" MF	1,52 €	1,68 €	1	12
GG1\2MF	1/2" MF	2,58 €	2,86 €	1	12
GG3\4MF	3/4" MF	3,39 €	3,76 €	1	12
GG1MF	1" MF	6,39 €	7,10 €	1	12
GG11\4MF	1"1/4 MF	8,58 €	9,53 €	1	12
GG11\2MF	1"1/2 MF	10,63 €	11,80 €	1	12
GG2MF	2" MF	18,20 €	20,20 €	1	12



Raccordo Tre Vie Gialla D. 1/4" TG1\4

Codice	Riferimenti	Listino A	Listino B	Off.	Box
TG1\4	1/4" FFF	1,26 €	1,40 €	1	12
TG3\8	3/8" FFF	1,78 €	1,98 €	1	12
TG1\2	1/2" FFF	2,84 €	3,15 €	1	12
TG3\4	3/4" FFF	4,46 €	4,95 €	1	12
TG1	1" FFF	7,58 €	8,42 €	1	12
TG11\4	1"1/4 FFF	9,24 €	10,25 €	1	12
TG11\2	1"1/2 FFF	12,00 €	13,32 €	1	12
TG2	2" FFF	21,15 €	23,47 €	1	12



Manicotto Ottone Giallo 1/4 MG1\4

Codice	Riferimenti	Listino A	Listino B	Off.	Box
MG1\4	1/4" FF	1,48 €	1,64 €	1	12
MG3\8	3/8" FF	1,07 €	1,19 €	1	12
MG1\2	1/2" FF	1,50 €	1,67 €	1	12
MG3\4	3/4" FF	2,30 €	2,55 €	1	12
MG1	1" FF	3,83 €	4,26 €	1	12
MG11\4	1"1/4 FF	4,68 €	5,20 €	1	12
MG11\2	1"1/2 FF	6,78 €	7,53 €	1	12
MG2	2" FF	12,54 €	13,92 €	1	12



Niples Ott. Giallo Da 1/8 NG1\8

Codice	Riferimenti	Listino A	Listino B	Off.	Box
NG1\8	1/8" MM	0,64 €	0,71 €	1	12
NG1\4	1/4" MM	0,50 €	0,56 €	1	12
NG3\8	3/8" MM	0,78 €	0,86 €	1	12
NG1\2	1/2" MM	1,10 €	1,22 €	1	12
NG3\4	3/4" MM	1,86 €	2,07 €	1	12
NG1	1" MM	2,83 €	3,14 €	1	12
NG11\4	1"1/4 MM	4,40 €	4,89 €	1	12
NG11\2	1"1/2 MM	4,91 €	5,45 €	1	12
NG2	2" MM	7,58 €	8,42 €	1	12



Controdado Flangia Giallo 3/8" CF3\8

Codice	Riferimenti	Listino A	Listino B	Off.	Box
CF3\8	1/2"	0,68 €	0,75 €	1	12
CF1\2	3/4"	0,79 €	0,87 €	1	12
CF3\4	1"	1,04 €	1,16 €	1	12
CF1	1" 1\4	1,25 €	1,39 €	1	12
CF11\4	1" 1\4	1,46 €	1,62 €	1	12
CF11\2	1" 1\2	1,93 €	2,14 €	1	12
CF2	2"	3,64 €	4,04 €	1	12



Tappo Giallo Maschio D. 1/4 TGM1\4

Codice	Riferimenti	Listino A	Listino B	Off.	Box
TGM1\4	1/4" M	0,57 €	0,64 €	1	12
TGM3\8	3/8" M	0,62 €	0,69 €	1	12
TGM1\2	1/2" M	0,92 €	1,02 €	1	12
TGM3\4	3/4" M	1,44 €	1,60 €	1	12
TGM1	1" M	1,48 €	1,65 €	1	12
TGM11\4	1"1/4 M	3,21 €	3,57 €	1	12
TGM11\2	1"1/2 M	4,10 €	4,56 €	1	12
TGM2	2" M	5,18 €	5,75 €	1	12



Tappo Giallo Femmina D. 1/4" TGF1\4

Codice	Riferimenti	Listino A	Listino B	Off.	Box
TGF1\4	1/4" F	0,28 €	0,31 €	1	12
TGF3\8	3/8" F	0,60 €	0,66 €	1	12
TGF1\2	1/2" F	0,86 €	0,96 €	1	12
TGF3\4	3/4" F	1,54 €	1,71 €	1	12
TGF1	1" F	1,48 €	1,65 €	1	12
TGF11\4	1"1/4 F	2,69 €	2,98 €	1	12
TGF11\2	1"1/2 F	3,70 €	4,11 €	1	12
TGF2	2" F	4,02 €	4,46 €	1	12

Raccordo 3 Pz Ott. Giallo 1/2"
BG1\2

Codice	Riferimenti	Listino A	Listino B	Off.	Box
BG1\2	1/2"	6,67 €	7,40 €	1	12
BG3\4	3/4"	8,48 €	9,41 €	1	12
BG1	1"	10,81 €	12,00 €	1	12
BG11\4	1" 1/4	18,96 €	21,05 €	1	12
BG11\2	1" 1/2	26,50 €	29,41 €	1	12
BG2	2"	40,28 €	44,71 €	1	12

Raccordo 3 Pz Ott. Giallo 1/2"
Mf BG1\2MF

Codice	Riferimenti	Listino A	Listino B	Off.	Box
BG1\2MF	1/2"	4,91 €	5,45 €	1	12
BG3\4MF	3/4"	7,23 €	8,02 €	1	12
BG1MF	1"	10,84 €	12,03 €	1	12
BG11\4MF	1" 1/4	15,70 €	17,43 €	1	12
BG11\2MF	1" 1/2	21,24 €	23,57 €	1	12
BG2MF	2"	31,45 €	34,91 €	1	12

Gomito Giallo 3 Pz Mf Da 1/2"
G3G1\2MF

Codice	Riferimenti	Listino A	Listino B	Off.	Box
G3G1\2MF	1/2" MF	2,63 €	2,92 €	1	12
G3G3\4MF	3/4" MF	12,13 €	13,47 €	1	12
G3G1MF	1" MF	18,48 €	20,51 €	1	12

Raccordo 3 Pz. Giallo 1/2" Mf
R3G1\2MF

Codice	Riferimenti	Listino A	Listino B	Off.	Box
R3G1\2MF	1/2" MF	2,53 €	2,81 €	1	12
R3G3\4MF	3/4" MF	3,92 €	4,35 €	1	12
R3G1MF	1" MF	10,84 €	12,03 €	1	12



Niples Ridotta Ottone Giallo MM

Codice	Riferimenti	Listino A	Listino B	Off.	Box
NRG3\8X1\4	3/8" X 1/4"	0,72 €	0,80 €	1	12
NRG1\2X1\4	1/2" X 1/4"	0,69 €	0,77 €	1	12
NRG1\2X3\8	1/2" X 3/8"	1,39 €	1,55 €	1	12
NRG3\4X1\2	3/4" X 1/2"	1,55 €	1,72 €	1	12
NRG1X1\2	1" X 1/2"	2,02 €	2,24 €	1	12
NRG1X3\4	1" X 3/4"	2,53 €	2,81 €	1	12
NRG11\4X3\4	1"1/4 X 3/4"	3,82 €	4,24 €	1	12
NRG11\2X3\4	1"1/2 X 3/4"	4,14 €	4,59 €	1	12
NRG11\2X1	1"1/2 X 1"	4,96 €	5,50 €	1	12
NRG2X3\4	2" X 3/4"	Arrivo	Arrivo	1	12

Manicotto Ottone Giallo Ridotto
FF

Codice	Riferimenti	Listino A	Listino B	Off.	Box
MRG3\8X1\4	3/8" X 1/4"	Arrivo	Arrivo	1	12
MRG1\2X1\4	1/2" X 1/4"	Arrivo	Arrivo	1	12
MRG1\2X3\8	1/2" X 3/8"	0,92 €	1,02 €	1	12
MRG3\4X1\2	3/4" X 1/2"	1,72 €	1,91 €	1	12
MRG1X1\2	1" X 1/2"	2,20 €	2,44 €	1	12
MRG1X3\4	1" X 3/4"	2,74 €	3,04 €	1	12
MRG11\4X3\4	1"1/4 X 3/4"	2,70 €	3,00 €	1	12
MRG11\2X3\4	1"1/2 X 3/4"	Arrivo	Arrivo	1	12
MRG11\2X1	1"1/2 X 1"	5,13 €	5,69 €	1	12
MRG2X3\4	2" X 3/4"	Arrivo	Arrivo	1	12

Prolunga Ridotta Ottone
Gialla FM

Codice	Riferimenti	Listino A	Listino B	Off.	Box
PRG1\4X1\8	1/4"x1/8"	1,08 €	1,20 €	1	12
PRG3\8X1\4	3/8" X 1/4"	1,22 €	1,35 €	1	12
PRG1\2X1\4	1/2"x1/4"	1,41 €	1,56 €	1	12
PRG1\2X3\8	1/2"x3/8"	1,20 €	1,34 €	1	12
PRG3\4X1\2	3/4x1/2"	2,26 €	2,50 €	1	12
PRG1X1\2	1"x1/2"	2,91 €	3,23 €	1	12
PRG1X3\4	1"x3/4"	3,32 €	3,69 €	1	12
PRG11\4X1	1"1\4X1"	5,10 €	5,66 €	1	12
PRG11\4X3\4	1"1\4X3\4"	5,49 €	6,09 €	1	12
PRG11\2X11\4	1"12x11\4"	5,87 €	6,52 €	1	12
PRG11\2X1	1"1\2x1"	6,61 €	7,34 €	1	12
PRG2X11\2	2"x11\2"	Arrivo	Arrivo	1	12
PRG2X11\4	2"x11\4"	Arrivo	Arrivo	1	12
PRG2X1	2"x1"	Arrivo	Arrivo	1	12



Riduzione Ottone Gialla MF

Codice	Riferimenti	Listino A	Listino B	Off.	Box
RG1\4X1\8	1/4"x1/8"	0,54 €	0,59 €	1	12
RG3\8X1\4	3/8" X 1/4"	0,41 €	0,46 €	1	12
RG1\2X1\4	1/2"x1/4"	0,87 €	0,97 €	1	12
RG1\2X3\8	1/2"x3/8"	0,63 €	0,70 €	1	12
RG3\4X1\2	3/4x1/2"	1,29 €	1,43 €	1	12
RG1X1\2	1"x1/2"	2,05 €	2,28 €	1	12
RG1X3\4	1"x3/4"	1,74 €	1,93 €	1	12
RG11\4X1	1"1\4X1"	3,02 €	3,36 €	1	12
RG11\4X3\4	1"1\4X3\4"	3,33 €	3,69 €	1	12
RG11\2X11\4	1"12x11\4"	2,77 €	3,07 €	1	12
RG11\2X1	1"1\2x1"	4,25 €	4,71 €	1	12
RG2X11\2	2"x11\2"	4,66 €	5,17 €	1	12
RG2X11\4	2"x11\4"	5,23 €	5,81 €	1	12
RG2X1	2"x1"	6,84 €	7,59 €	1	12



Gomito Ottone Giallo Ridotto
FF

Codice	Riferimenti	Listino A	Listino B	Off.	Box
GGRDC	1/2X3/8	Arrivo	Arrivo	1	12
GGRGD	3/4x1/2"	2,05 €	2,28 €	1	12
GGRHD	1"x1/2"	7,31 €	8,12 €	1	12
GGRHG	1"x3/4"	4,36 €	4,84 €	1	12



Gomito Ottone Giallo 1/2"
Flangiato GGF1\2

Codice	Riferimenti	Listino A	Listino B	Off.	Box
GGF1\2	1/2"	1,78 €	1,98 €	1	12



Prolunga Ott. Gialla 3/8"X10 P.
PG3\8X10P

Codice	Riferimenti	Listino A	Listino B	Off.	Box
PG3\8X10P	1/2"X10 mm	1,08 €	1,19 €	1	12
PG3\8X15P	1/2"X15 mm	1,30 €	1,44 €	1	12
PG3\8X20P	1/2"X20 mm	1,50 €	1,66 €	1	12
PG3\8X25P	1/2"X25 mm	1,77 €	1,96 €	1	12
PG3\8X30P	1/2"X30 mm	2,04 €	2,26 €	1	12
PG3\8X40P	1/2"X40 mm	2,86 €	3,17 €	1	12
PG3\8X50P	1/2"X50 mm	3,34 €	3,70 €	1	12



Prolunga Ott. G. 1/2"X10 P.
PG1\2X10P

Codice	Riferimenti	Listino A	Listino B	Off.	Box
PG1\2X10P	1/2"X10 mm	1,22 €	1,35 €	1	12
PG1\2X15P	1/2"X15 mm	1,56 €	1,73 €	1	12
PG1\2X20P	1/2"X20 mm	1,84 €	2,04 €	1	12
PG1\2X25P	1/2"X25 mm	2,18 €	2,42 €	1	12
PG1\2X30P	1/2"X30 mm	2,32 €	2,57 €	1	12
PG1\2X40P	1/2"X40 mm	2,94 €	3,27 €	1	12
PG1\2X50P	1/2"X50 mm	3,59 €	3,99 €	1	12



Prolunga Gialla 3/4"X10 Pes.
PG3\4X10P

Codice	Riferimenti	Listino A	Listino B	Off.	Box
PG3\4X10P	1/2"X10 mm	2,09 €	2,32 €	1	12
PG3\4X15P	1/2"X15 mm	2,60 €	2,89 €	1	12
PG3\4X20P	1/2"X20 mm	2,91 €	3,23 €	1	12
PG3\4X25P	1/2"X25 mm	3,37 €	3,74 €	1	12
PG3\4X30P	1/2"X30 mm	3,82 €	4,24 €	1	12
PG3\4X40P	1/2"X40 mm	4,50 €	4,99 €	1	12
PG3\4X50P	1/2"X50 mm	5,49 €	6,09 €	1	12



Riduzione Ottone Gialla
Prolungata MF

Codice	Riferimenti	Listino A	Listino B	Off.	Box
RG1\2X3\8P	1/2"x3/8"	0,98 €	1,09 €	1	12
RG3\4X1\2P	3/4x1/2"	1,52 €	1,68 €	1	12



Raccordo Tre Vie Gialla D. 1"
Maschio TG1M

Codice	Riferimenti	Listino A	Listino B	Off.	Box
TG1M	1"	8,68 €	9,64 €	1	12



Prolunga Gialla Pes. 1"X10
PG1X10P

Codice	Riferimenti	Listino A	Listino B	Off.	Box
PG1X10P	1/2"X10 mm	2,63 €	2,92 €	1	12
PG1X15P	1/2"X15 mm	3,22 €	3,58 €	1	12
PG1X20P	1/2"X20 mm	3,79 €	4,21 €	1	12
PG1X25P	1/2"X25 mm	4,31 €	4,79 €	1	12
PG1X30P	1/2"X30 mm	4,84 €	5,37 €	1	12
PG1X40P	1/2"X40 mm	5,91 €	6,56 €	1	12
PG1X50P	1/2"X50 mm	6,93 €	7,69 €	1	12



Kronos Femm. Riparatubi 3/8"
KF3\8

Codice	Riferimenti	Listino A	Off.	Listino B	Box
KF3\8	D.. 3/8"	6,93 €		7,70 €	1 12
KF1\2	D.. 1/2"	8,20 €		9,10 €	1 12
KF3\4	D.. 3/4"	11,28 €		12,52 €	1 12
KF1	D.. 1"	13,71 €		15,21 €	1 12



Kronos Maschio Riparatubi 3/8"
KM3\8

Codice	Riferimenti	Listino A	Off.	Listino B	Box
KM3\8	D.. 3/8"	6,93 €		7,70 €	1 12
KM1\2	D.. 1/2"	8,20 €		9,10 €	1 12
KM3\4	D.. 3/4"	11,28 €		12,52 €	1 12
KM1	D.. 1"	13,71 €		15,21 €	1 12



Barilotto in Ottone Giallo

Codice	Riferimenti	Listino A	Listino B	Off.	Box
BG1\2X40	1/2"X40	2,23 €	2,48 €	1	10
BG1\2X50	1/2"X50	1,84 €	2,05 €	1	10
BG1\2X60	1/2"X60	2,23 €	2,48 €	1	10
BG1\2X70	1/2"X70	2,55 €	2,83 €	1	10
BG1\2X80	1/2"X80	3,50 €	3,88 €	1	10
BG1\2X100	1/2"X100	4,90 €	5,44 €	1	10
BG1\2X150	1/2"X150	7,82 €	8,68 €	1	10
BG1\2X200	1/2"X200	9,53 €	10,58 €	1	10
BG3\4X50	3/4"X50	2,97 €	3,30 €	1	10
BG3\4X60	3/4"X60	2,97 €	3,30 €	1	10
BG3\4X70	3/4"X70	3,30 €	3,66 €	1	10
BG3\4X80	3/4"X80	3,85 €	4,27 €	1	10
BG3\4X100	3/4"X100	5,43 €	6,03 €	1	10
BG3\4X150	3/4"X150	9,28 €	10,30 €	1	10
BG3\4X200	3/4"X200	11,13 €	12,35 €	1	10
BG1X50	1"X50	3,89 €	4,32 €	1	10
BG1X60	1"X60	3,98 €	4,42 €	1	10
BG1X70	1"X70	4,57 €	5,08 €	1	10
BG1X80	1"X80	5,23 €	5,80 €	1	10
BG1X100	1"X100	9,04 €	10,03 €	1	10
BG1X150	1"X150	12,87 €	14,28 €	1	10
BG1X200	1"X200	15,66 €	17,38 €	1	10

Tappo Maschio Con Rosetta
1/2" TMCR

Codice	Riferimenti	Listino A	Listino B	Off.	Box
TMCR		1,64 €	1,82 €	1	20
TMCRx5	Offertax5	1,54 €	1,71 €	5	20
TMCRx10	Offertax10	1,48 €	1,64 €	10	20
TMCRx20	Offertax20	1,42 €	1,57 €	20	20

Portagomma In Ottone
Maschio

Codice	Riferimenti	Listino A	Listino B	Off.	Box
PGM1\2X13	1/2X13	1,12 €	1,24 €	1	10
PGM3\4X20	3/4X20	1,90 €	2,11 €	1	10
PGM1X25	1"X25	2,97 €	3,30 €	1	5
PGM11\4X30	1"1/4X30	3,17 €	3,52 €	1	5
PGM11\4X40	1"1/4X40	4,39 €	4,87 €	1	5
PGM11\2X40	1"1/2X40	4,98 €	5,53 €	1	5
PGM2X50	2"X50	6,99 €	7,76 €	1	3

Raccordo Cassone con
raccordo smontabile

Codice	Riferimenti	Listino A	Listino B	Pz	Box
R3C1\2	1/2"	4,96 €	5,50 €	1	10
R3C3\4	3/4"	7,86 €	8,72 €	1	10
R3C1	1"	10,83 €	12,02 €	1	5
R3C11\4	1" 1\4	14,92 €	16,56 €	1	5
R3C11\2	1"1\2	21,54 €	23,91 €	1	5
R3C2	2"	28,80 €	31,97 €	1	5

Portagomma In Ottone
Maschio con bocchettone
"Excelsior"

Codice	Riferimenti	Listino A	Listino B	Off.	Box
RE1\2	1/2X15	3,00 €	3,33 €	1	10
RE3\4	3/4X20	5,35 €	5,94 €	1	10
RE1	1"X25	8,97 €	9,96 €	1	10
RE11\4	1"1/4X30	11,92 €	13,23 €	1	5
RE11\2	1"1/2X40	13,26 €	14,72 €	1	5
RE2	2"X50	19,80 €	21,98 €	1	5



Raccordo Cassone A Piletta

Codice	Riferimenti	Listino A	Listino B	Pz	Box
RCP1\2	1/2"	4,01 €	4,45 €	1	10
RCP3\4	3/4"	5,71 €	6,34 €	1	10
RCP1	1"	7,11 €	7,89 €	1	5
RCP11\4	1" 1\4	9,91 €	11,00 €	1	5
RCP11\2	1"1\2	20,72 €	23,00 €	1	5
RCP2	2"	21,81 €	24,21 €	1	5



Gomito Cromato Ff 3/8 GC3\8

Codice	Riferimenti	Listino A	Off.	Listino B	Box
GC3\8	D. 3/8"	1,74 €	10	€ 1,52	218
GC1\2	D. 1/2"	2,15 €	10	€ 1,88	175
GC3\4	D. 3/4"	2,53 €	10	€ 2,21	110
GC1	D. 1"	4,14 €	10	€ 3,62	50



Gomito Cromo 3/8" Mf Zx GC3\8MF

Codice	Riferimenti	Listino A	Listino B	Off.	Box
GC3\8MF	D. 3/8"	1,74 €	1,93 €	1	12
GC1\2MF	D. 1/2"	2,51 €	2,78 €	1	12
GC3\4MF	D. 3/4"	3,91 €	4,34 €	1	12
GC1MF	D. 1"	6,78 €	7,52 €	1	12



Tee Cromata

Codice	Riferimenti	Listino A	Listino B	Off.	Box
TC3\8	D. 3/8"	1,92 €	2,13 €	1	12
TC1\2	D. 1/2"	3,27 €	3,63 €	1	12
TC3\4	D. 3/4"	4,95 €	5,49 €	1	12
TC1	D. 1"	7,27 €	8,07 €	1	12



Niplo Cromato

Codice	Riferimenti	Listino A	Listino B	Off.	Box
NC3\8	D. 3/8"	1,12 €	1,24 €	1	12
NC1\2	D. 1/2"	1,38 €	1,53 €	1	12
NC3\4	D. 3/4"	1,98 €	2,20 €	1	12
NC1	D. 1"	3,50 €	3,89 €	1	12



Manicotto Cromo

Codice	Riferimenti	Listino A	Listino B	Off.	Box
MC3\8	D. 3/8"	1,28 €	1,42 €	1	12
MC1\2	D. 1/2"	1,76 €	1,95 €	1	12
MC3\4	D. 3/4"	2,52 €	2,80 €	1	12
MC1	D. 1"	4,77 €	5,29 €	1	12



Nipples Cromo Ridotto

Codice	Riferimenti	Listino A	Listino B	Off.	Box
NCR1\2X3\8	1/2M X3/8M	1,85 €	2,05 €	1	12
NCR3\4X1\2	3/4 M X1/2M	2,49 €	2,76 €	1	12



Tappo Maschio Cromo

Codice	Riferimenti	Listino A	Listino B	Off.	Box
TCM3\8	D. 3/8"	0,72 €	0,80 €	1	12
TCM1\2	D. 1/2"	0,91 €	1,01 €	1	12
TCM3\4	D. 3/4"	1,36 €	1,51 €	1	12
TCM1	D. 1"	2,09 €	2,32 €	1	12



Tappo Femmina Cromo

Codice	Riferimenti	Listino A	Listino B	Off.	Box
TCF3\8	D. 3/8"	0,83 €	0,92 €	1	12
TCF1\2	D. 1/2"	0,77 €	0,86 €	1	12
TCF3\4	D. 3/4"	1,37 €	1,52 €	1	12
TCF1	D. 1"	1,96 €	2,18 €	1	12



Riduzione Cromo

Codice	Riferimenti	Listino A	Listino B	Off.	Box
RC1\2X3\8	1/2M X3/8F	1,17 €	1,30 €	1	12
RC3\4X1\2	3/4M X1/2F	1,12 €	1,24 €	1	12



Prolunga Ridotta Cromata

Codice	Riferimenti	Listino A	Listino B	Off.	Box
PRC1\2X3\8	1/2F X3/8M	1,66 €	1,85 €	1	12
PRC3\4X1\2	3/4F X1/2M	2,08 €	2,31 €	1	12
PRC1X3\4	1F X3/4M	3,47 €	3,85 €	1	12
PRC1X1\2	1F X1/2M	4,55 €	5,05 €	1	12



Prolunga Ottone Cromato MF 3/8"

Codice	Riferimenti	Listino A	Listino B	Off.	Box
PC3\8X10	3/8X10 mm	1,23 €	1,36 €	1	12
PC3\8X15	3/8X15 mm	1,49 €	1,66 €	1	12
PC3\8X20	3/8X20 mm	1,68 €	1,87 €	1	12
PC3\8X25	3/8X25 mm	1,96 €	2,18 €	1	12
PC3\8X30	3/8X30 mm	2,24 €	2,48 €	1	12
PC3\8X40	3/8X40 mm	2,83 €	3,14 €	1	12
PC3\8X50	3/8X50 mm	3,76 €	4,18 €	1	12



Prolunga Ottone Cromato MF 1/2"

Codice	Riferimenti	Listino A	Listino B	Off.	Box
PC1\2X10	3/8X10 mm	1,33 €	1,48 €	1	12
PC1\2X15	3/8X15 mm	1,70 €	1,88 €	1	12
PC1\2X20	3/8X20 mm	1,98 €	2,20 €	1	12
PC1\2X25	3/8X25 mm	2,32 €	2,57 €	1	12
PC1\2X30	3/8X30 mm	2,46 €	2,73 €	1	12
PC1\2X40	3/8X40 mm	3,11 €	3,45 €	1	12
PC1\2X50	3/8X50 mm	3,83 €	4,25 €	1	12



Prolunga Ottone Cromato MF 3/4"

Codice	Riferimenti	Listino A	Listino B	Off.	Box
PC3\4X10	3/8X10 mm	2,26 €	2,51 €	1	12
PC3\4X15	3/8X15 mm	2,77 €	3,08 €	1	12
PC3\4X20	3/8X20 mm	3,08 €	3,42 €	1	12
PC3\4X25	3/8X25 mm	3,78 €	4,20 €	1	12
PC3\4X30	3/8X30 mm	4,53 €	5,03 €	1	12
PC3\4X40	3/8X40 mm	5,45 €	6,05 €	1	12
PC3\4X50	3/8X50 mm	6,40 €	7,11 €	1	12



PROCHBH Prolunga Ridotta Cromata 1 1/4" F X1" M Zz Ex Prc11/4X1 PROCHBH

PROCHDHB Prolunga Ridotta Cromata Fm 1 1/2" X1 1/4 PROCHDHB

Codice	Riferimenti	Listino A	Listino B	Off.	Box
PROCHBH	1" 1/4 X1"	5,14 €	5,70 €	1	50
PROCHDHB	1" 1/2 X1" 1/4	5,14 €	5,70 €	1	50



RM114100 Riduzione Cromata 1 1/4" M X1" F RM114100

RM1121140 Riduzione Cromata D. 1 1/2" M x 1 1/4" F RM1121140

Codice	Riferimenti	Listino A	Listino B	Off.	Box
RM114100	1" 1/4 x 1"	5,14 €	5,70 €	1	50
RM1121140	1" 1/2 x 1" 1/4	6,33 €	7,02 €	1	50



Nipples Cromo Femmina bicono

Codice	Riferimenti	Listino A	Listino B	Off.	Box
NFC1\2X10	10 x 1/2	1,64 €	1,83 €	1	12



Nipples Cromo maschio bicono

Codice	Riferimenti	Listino A	Listino B	Off.	Box
NMC3\8X1	10 x 3/8	0,89 €	0,98 €	1	12
NMC1\2X10	10 x 1/2	1,64 €	1,83 €	1	12



Nipples cromata Esagonale maschio bicono con prolunga

Codice	Riferimenti	Listino A	Listino B	Off.	Box
NMCPD10	1/2" X (3/8" X10)	2,35 €	2,61 €	1	12



Nipples cromata Esagonale ridotta con prolunga

Codice	Riferimenti	Listino A	Listino B	Off.	Box
N CPRDC	1/2" X3/8"	2,16 €	2,40 €	1	12
N CPRDD	1/2" X1/2"	2,01 €	2,23 €	1	12



Rame Cotto Cromato Da 10 Mm RC10

Codice	Riferimenti	Listino A	Listino B	Off.	Box
RC10	Mt. 5	5,13 €	5,69 €	1	5



Rubinetto A "T" X Lav. 1/2" X3/4" RTL

Codice	Riferimenti	Listino A	Listino B	Off.	Box
RTL	Cromo	6,24 €	6,93 €	1	12
RTLx5	Off.x5	5,99 €	6,65 €	5	12



Raccordo Cromo 1/2" M "Y" Usc. F. RY1\2

Codice	Riferimenti	Listino A	Listino B	Off.	Box
RCY1\2	D. 1/2"	5,75 €	6,38 €	1	12



Curva a 90° M/F
Fig. 1

Codice	Riferimenti	Listino A	Listino B	Off.	Box
CZ1\2MF	D. 1/2"	1,67 €	1,85 €	1	10
CZ3\4MF	D. 3/4"	2,91 €	3,23 €	1	10
CZ1MF	D. 1"	3,96 €	4,40 €	1	10
CZ11\4MF	D. 1 1/4"	6,83 €	7,58 €	1	10
CZ11\2MF	D. 1 1/2"	9,06 €	10,05 €	1	10
CZ2MF	D. 2"	15,76 €	17,49 €	1	10
CZ21\2MF	D. 2 1/2"	32,84 €	36,45 €	1	10
CZ3MF	D. 3"	42,10 €	46,73 €	1	10
CZ4MF	D. 4"	76,46 €	84,87 €	1	10



Curva a 90° F/F
Fig. 2

Codice	Riferimenti	Listino A	Listino B	Off.	Box
CZ1\2FF	D. 1/2"	1,90 €	2,11 €	1	10
CZ3\4FF	D. 3/4"	2,94 €	3,26 €	1	10
CZ1FF	D. 1"	3,96 €	4,40 €	1	10
CZ11\4FF	D. 1 1/4"	6,87 €	7,63 €	1	10
CZ11\2FF	D. 1 1/2"	7,82 €	8,68 €	1	10
CZ2FF	D. 2"	12,68 €	14,07 €	1	10
CZ21\2FF	D. 2 1/2"	30,51 €	33,87 €	1	10
CZ3FF	D. 3"	38,38 €	42,61 €	1	10
CZ4FF	D. 4"	72,77 €	80,77 €	1	10



Gomito Zincato Mf
Fig.92

Codice	Riferimenti	Listino A	Listino B	Off.	Box
GZ1\2MF	D. 1/2"	0,68 €	0,76 €	1	10
GZ3\4MF	D. 3/4"	1,38 €	1,53 €	1	10
GZ1MF	D. 1"	1,94 €	2,15 €	1	10
GZ11\4MF	D. 1 1/4"	3,33 €	3,70 €	1	10
GZ11\2MF	D. 1 1/2"	5,00 €	5,55 €	1	10
GZ2MF	D. 2"	6,07 €	6,74 €	1	10
GZ21\2MF	D. 2 1/2"	12,50 €	13,88 €	1	10
GZ3MF	D. 3"	18,80 €	20,86 €	1	10
GZ4MF	D. 4"	46,74 €	51,88 €	1	10



Gomito Zincato
Fig. 90

Codice	Riferimenti	Listino A	Listino B	Off.	Box
GZ1\2	D. 1/2"	0,76 €	0,84 €	1	10
GZ3\4	D. 3/4"	1,38 €	1,53 €	1	10
GZ1	D. 1"	2,09 €	2,32 €	1	10
GZ11\4	D. 1 1/4"	3,63 €	4,03 €	1	10
GZ11\2	D. 1 1/2"	4,58 €	5,09 €	1	10
GZ2	D. 2"	6,43 €	7,14 €	1	10
GZ21\2	D. 2 1/2"	14,01 €	15,55 €	1	10
GZ3	D. 3"	21,73 €	24,12 €	1	10
GZ4	D. 4"	49,44 €	54,88 €	1	10



Tee Zincato Fig.
130

Codice	Riferimenti	Listino A	Listino B	Off.	Box
TZ1\2	D. 1/2"	1,02 €	1,13 €	1	10
TZ3\4	D. 3/4"	1,76 €	1,96 €	1	10
TZ1	D. 1"	2,00 €	2,22 €	1	10
TZ11\4	D. 1 1/4"	3,86 €	4,29 €	1	10
TZ11\2	D. 1 1/2"	5,30 €	5,89 €	1	10
TZ2	D. 2"	7,46 €	8,28 €	1	10
TZ21\2	D. 2 1/2"	26,30 €	29,19 €	1	10
TZ3	D. 3"	21,46 €	23,82 €	1	10
TZ4	D. 4"	36,68 €	40,71 €	1	10



Bocchettone F/F Fig.
340

Codice	Riferimenti	Listino A	Listino B	Off.	Box
BZ1\2	D. 1/2"	2,91 €	3,23 €	1	10
BZ3\4	D. 3/4"	3,29 €	3,65 €	1	10
BZ1	D. 1"	4,30 €	4,77 €	1	10
BZ11\4	D. 1 1/4"	6,53 €	7,25 €	1	10
BZ11\2	D. 1 1/2"	7,65 €	8,49 €	1	10
BZ2	D. 2"	14,25 €	15,81 €	1	10
BZ21\2	D. 2 1/2"	29,00 €	32,19 €	1	10
BZ3	D. 3"	40,46 €	44,91 €	1	10
BZ4	D. 4"	75,55 €	83,86 €	1	10



Curva di Sorpasso
Fig. 85

Codice	Riferimenti	Listino A	Listino B	Off.	Box
SSZ1\2	D. 1/2"	2,09 €	2,31 €	1	10
SSZ3\4	D. 3/4"	Arrivo	Arrivo	1	10
SSZ1	D. 1"	Arrivo	Arrivo	1	10



Bocchettone M/F Fig.
341

Codice	Riferimenti	Listino A	Listino B	Off.	Box
BZ1\2MF	D. 1/2"	3,81 €	4,23 €	1	10
BZ3\4MF	D. 3/4"	4,58 €	5,09 €	1	10
BZ1MF	D. 1"	4,13 €	4,58 €	1	10
BZ11\4MF	D. 1 1/4"	5,57 €	6,19 €	1	10



Manicotto Zincato
F.270

Codice	Riferimenti	Listino A	Listino B	Off.	Box
MZ1\2	D. 1/2"	0,87 €	0,97 €	1	10
MZ3\4	D. 3/4"	1,18 €	1,31 €	1	10
MZ1	D. 1"	1,57 €	1,74 €	1	10
MZ11\4	D. 1 1/4"	2,46 €	2,73 €	1	10
MZ11\2	D. 1 1/2"	3,55 €	3,94 €	1	10
MZ2	D. 2"	5,25 €	5,83 €	1	10
MZ21\2	D. 2 1/2"	10,83 €	12,02 €	1	10
MZ3	D. 3"	12,63 €	14,01 €	1	10
MZ4	D. 4"	25,00 €	27,75 €	1	10



Niples Zincato Fig.280

Codice	Riferimenti	Listino A	Listino B	Off.	Box
NZ1\2	D. 1/2"	0,58 €	0,64 €	1	10
NZ3\4	D. 3/4"	1,00 €	1,11 €	1	10
NZ1	D. 1"	1,46 €	1,62 €	1	10
NZ11\4	D. 1 1/4"	2,63 €	2,92 €	1	10
NZ11\2	D. 1 1/2"	2,20 €	2,44 €	1	10
NZ2	D. 2"	5,12 €	5,68 €	1	10
NZ21\2	D. 2 1/2"	9,20 €	10,21 €	1	10
NZ3	D. 3"	7,94 €	8,82 €	1	10
NZ4	D. 4"	25,00 €	27,75 €	1	10



Tappo Femmina
Zincato
F. 300

Codice	Riferimenti	Listino A	Listino B	Off.	Box
TZF1\2	D. 1/2"	0,98 €	1,09 €	1	10
TZF3\4	D. 3/4"	0,88 €	0,98 €	1	10
TZF1	D. 1"	1,04 €	1,15 €	1	10
TZF11\4	D. 1 1/4"	1,56 €	1,73 €	1	10
TZF11\2	D. 1 1/2"	1,93 €	2,15 €	1	10
TZF2	D. 2"	3,65 €	4,05 €	1	10
TZF21\2	D. 2 1/2"	6,66 €	7,40 €	1	10
TZF3	D. 3"	7,03 €	7,81 €	1	10
TZF4	D. 4"	15,38 €	17,08 €	1	10



Tappo M con Bordo
Fig. 290

Codice	Riferimenti	Listino A	Listino B	Off.	Box
TZM1\2	D. 1/2"	0,89 €	0,98 €	1	10
TZM3\4	D. 3/4"	0,61 €	0,68 €	1	10
TZM1	D. 1"	0,67 €	0,75 €	1	10
TZM11\4	D. 1 1/4"	1,24 €	1,38 €	1	10
TZM11\2	D. 1 1/2"	2,09 €	2,32 €	1	10
TZM2	D. 2"	2,78 €	3,08 €	1	10
TZM21\2	D. 2 1/2"	6,08 €	6,74 €	1	10
TZM3	D. 3"	7,59 €	8,43 €	1	10
TZM4	D. 4"	13,36 €	14,83 €	1	10



Manicotto Ridotto F/F
Fig. 240

Codice	Riferimenti	Listino A	Listino B	Off.	Box
MZR3\4x1\2	3/4"x1/2"	1,56 €	1,73 €	1	5
MZR1X3\4	1"x3/4"	1,78 €	1,98 €	1	5
MZR1X1\2	1"x1/2"	1,96 €	2,17 €	1	5



Tee Zincata 4 Vie F. 223
D.1/2"

Codice	Riferimenti	Listino A	Listino B	Off.	Box
TZ4V1\2	D. 1/2"	3,44 €	3,82 €	1	5
TZ4V3\4	D. 3/4"	4,30 €	4,77 €	1	5
TZ4V1	D. 1"	6,35 €	7,05 €	1	5



Manicotto Ridotto F/M
Fig. 246

Codice	Riferimenti	Listino A	Listino B	Off.	Box
MZ1\2MF	D. 1/2"	1,14 €	1,26 €	1	5
MZ3\4MF	D. 3/4"	2,37 €	2,63 €	1	5
MZ1MF	D. 1"	3,68 €	4,09 €	1	5
MZ11\4MF	D. 1 1/4"	3,37 €	3,74 €	1	5
MZ11\2MF	D. 1 1/2"	Arrivo	Arrivo	1	5
MZ2MF	D. 2"	Arrivo	Arrivo	1	5



Gomito Zinc. 3 V. 1/2"
F.
221

Codice	Riferimenti	Listino A	Listino B	Off.	Box
GZ3V1\2	D. 1/2"	2,47 €	2,74 €	1	5
GZ3V3\4	D. 3/4"	3,95 €	4,38 €	1	5
GZ3V1	D. 1"	5,22 €	5,79 €	1	5
GZ3V11\4	D. 1 1/4"	9,25 €	10,27 €	1	5

Nipplo Ridotto M/M
Fig. 245



Codice	Riferimenti	Listino A	Listino B	Off.	Box
NZR3/4X1/2	3/4"x1/2"	1,60 €	1,77 €	1	5
NZR1X1/2	1"x1/2"	3,24 €	3,60 €	1	5
NZR1X3/4	1"x3/4"	1,84 €	2,05 €	1	5
NZR11/4X1	1 1/4"x1"	2,91 €	3,23 €	1	5
NZR11/2X1 1/4	1 1/2"x1 1/4"	3,68 €	4,09 €	1	5
NZR11/2X1	1 1/2"x1"	6,78 €	7,53 €	1	5
NZR2X1 1/2	2"x1 1/2"	6,95 €	7,71 €	1	5
NZR2X1 1/4	2"x1 1/4"	5,47 €	6,07 €	1	5



Gomito Ridotto a 90°
F/F Fig. 90R

Codice	Riferimenti	Listino A	Listino B	Off.	Box
GZR3/4X1/2	3/4"x1/2"	1,62 €	1,79 €	1	5
GZR1X1/2	1"x1/2"	1,70 €	1,89 €	1	5
GZR1X3/4	1"x3/4"	1,79 €	1,99 €	1	5



Nipplo Tutto Filetto
Fig. 531

Codice	Riferimenti	Listino A	Listino B	Off.	Box
PZ1/2	D. 1/2"	0,77 €	0,86 €	1	5
PZ3/4	D. 3/4"	0,91 €	1,01 €	1	5
PZ1	D. 1"	1,16 €	1,28 €	1	5
PZ1 1/4	D. 1 1/4"	2,34 €	2,60 €	1	5
PZ1 1/2	D. 1 1/2"	14,70 €	16,32 €	1	5
PZ2	D. 2"	22,49 €	24,96 €	1	5



Croce Zincata Fig. 180

Codice	Riferimenti	Listino A	Listino B	Off.	Box
CZ1/2	D. 1/2"	2,63 €	2,92 €	1	5
CZ3/4	D. 3/4"	3,95 €	4,38 €	1	5
CZ1	D. 1"	4,88 €	5,42 €	1	5
CZ1 1/4	D. 1 1/4"	6,55 €	7,27 €	1	5
CZ1 1/2	D. 1 1/2"	8,75 €	9,72 €	1	5
CZ2	D. 2"	13,31 €	14,77 €	1	5
CZ2 1/2	D. 2 1/2"	29,53 €	32,78 €	1	5
CZ3	D. 3"	34,03 €	37,77 €	1	5
CZ4	D. 4"	89,44 €	99,28 €	1	5

Riduzione M/F
Fig. 241



Codice	Riferimenti	Listino A	Listino B	Off.	Box
RZ3/4X1/2	3/4"X1/2"	0,82 €	0,91 €	1	5
RZ1X1/2	1"X1/2"	1,15 €	1,28 €	1	5
RZ1X3/4	1"X3/4"	0,84 €	0,93 €	1	5
RZ1 1/4X1/2	1" 1/4X1/2"	1,99 €	2,21 €	1	5
RZ1 1/4X3/4	1" 1/4X3/4"	1,78 €	1,98 €	1	5
RZ1 1/4X1	1" 1/4X1"	1,12 €	1,24 €	1	5
RZ1 1/2X1/2	1" 1/2X1/2"	1,90 €	2,11 €	1	5
RZ1 1/2X3/4	1" 1/2X3/4"	2,91 €	3,23 €	1	5
RZ1 1/2X1	1" 1/2X1"	1,70 €	1,88 €	1	5
RZ1 1/2X1 1/4	1" 1/2X1 1/4"	1,70 €	1,88 €	1	5
RZ2X1/2	2"X1/2"	3,80 €	4,21 €	1	5
RZ2X3/4	2"X3/4"	5,23 €	5,81 €	1	5
RZ2X1	2"X1"	3,09 €	3,43 €	1	5
RZ2X1 1/4	2"X1 1/4"	2,94 €	3,26 €	1	5
RZ2X1 1/2	2"X1 1/2"	3,66 €	4,07 €	1	5
RZ2 1/2X1 1/2	2" 1/2X1 1/2"	6,63 €	7,36 €	1	5
RZ2 1/2X2	2" 1/2X2"	7,05 €	7,82 €	1	5
RZ3X2	3"X2"	9,08 €	10,08 €	1	5
RZ4X3	4"X3"	14,70 €	16,32 €	1	5
RZ4X2	4"X2"	22,49 €	24,96 €	1	5



Tubo Zincato Saldato Norme
Uni Tubo Mt. 6

Codice	Riferimenti	Listino A	Listino B	Off.	Box
TZ1/2E	D. 1/2"	34,73 €	38,56 €	1	5
TZ3/4E	D. 3/4"	42,63 €	47,32 €	1	5
TZ1E	D. 1"	61,45 €	68,21 €	1	5
TZ1 1/4E	D. 1 1/4"	78,82 €	87,49 €	1	5
TZ1 1/2E	D. 1 1/2"	83,47 €	92,65 €	1	5
TZ2E	D. 2"	113,82 €	126,34 €	1	5



Collare Pesante
Completo

Codice	Riferimenti	Listino A	Listino B	Off.	Box
CPT1/2	D.1/2"	0,58 €	0,64 €	1	10
CPT3/4	D.3/4"	0,62 €	0,69 €	1	10
CPT1	D.1"	0,64 €	0,71 €	1	10
CPT1 1/4	D.1" 1/4"	0,68 €	0,75 €	1	10
CPT1 1/2	D.1" 1/2"	0,72 €	0,79 €	1	10
CPT2	D.2"	0,82 €	0,91 €	1	10

Barilotto Zincato
D. 1/2"

Codice	Riferimenti	Listino A	Listino B	Off.	Box
BZ1\2X100	1/2"X100mm	1,41 €	1,56 €	1	10
BZ1\2X150	1/2"X150mm	1,88 €	2,09 €	1	10
BZ1\2X200	1/2"X200mm	1,29 €	1,43 €	1	10
BZ1\2X250	1/2"X250mm	1,63 €	1,81 €	1	10
BZ1\2X300	1/2"X300mm	1,77 €	1,97 €	1	10
BZ1\2X400	1/2"X400mm	4,83 €	5,36 €	1	10
BZ1\2X500	1/2"X500mm	5,77 €	6,40 €	1	10
BZ1\2X1000	1/2"X1000mm	11,13 €	12,36 €	1	10

Barilotto Zincato
D. 1 1/2"

Codice	Riferimenti	Listino A	Listino B	Off.	Box
BZ11\2X100	1 1/2"X100mm	2,66 €	2,95 €	1	5
BZ11\2X150	1 1/2"X150mm	3,64 €	4,04 €	1	5
BZ11\2X200	1 1/2"X200mm	3,37 €	3,74 €	1	5
BZ11\2X250	1 1/2"X250mm	7,40 €	8,21 €	1	5
BZ11\2X300	1 1/2"X300mm	4,83 €	5,36 €	1	5
BZ11\2X400	1 1/2"X400mm	6,96 €	7,72 €	1	5
BZ11\2X500	1 1/2"X500mm	7,84 €	8,71 €	1	5
BZ11\2X1000	1 1/2"X1000	15,79 €	17,53 €	1	5

Barilotto Zincato
D. 3/4"

Codice	Riferimenti	Listino A	Listino B	Off.	Box
BZ3\4X100	3/4"X100mm	0,94 €	1,05 €	1	10
BZ3\4X150	3/4"X150mm	1,23 €	1,37 €	1	10
BZ3\4X200	3/4"X200mm	1,47 €	1,63 €	1	10
BZ3\4X250	3/4"X250mm	1,82 €	2,02 €	1	10
BZ3\4X300	3/4"X300mm	2,15 €	2,39 €	1	10
BZ3\4X400	3/4"X400mm	6,04 €	6,71 €	1	10
BZ3\4X500	3/4"X500mm	7,18 €	7,96 €	1	10
BZ3\4X1000	3/4"X1000mm	6,88 €	7,64 €	1	10

Barilotto Zincato
D. 2"

Codice	Riferimenti	Listino A	Listino B	Off.	Box
BZ2X100	2"X100mm	3,95 €	4,39 €	1	5
BZ2X150	2"X150mm	3,64 €	4,04 €	1	5
BZ2X200	2"X200mm	4,55 €	5,06 €	1	5
BZ2X250	2"X250mm	6,00 €	6,66 €	1	5
BZ2X300	2"X300mm	9,94 €	11,03 €	1	5
BZ2X400	2"X400mm	9,74 €	10,81 €	1	5
BZ2X500	2"X500mm	11,82 €	13,12 €	1	5
BZ2X1000	2"X1000mm	21,35 €	23,70 €	1	5

Barilotto Zincato
D. 1"

Codice	Riferimenti	Listino A	Listino B	Off.	Box
BZ1X100	1"X100mm	1,16 €	1,29 €	1	5
BZ1X150	1"X150mm	1,64 €	1,83 €	1	5
BZ1X200	1"X200mm	2,93 €	3,26 €	1	5
BZ1X250	1"X250mm	2,73 €	3,03 €	1	5
BZ1X300	1"X300mm	3,26 €	3,62 €	1	5
BZ1X400	1"X400mm	7,60 €	8,44 €	1	5
BZ1X500	1"X500mm	7,83 €	8,69 €	1	5
BZ1X1000	1"X1000mm	10,22 €	11,35 €	1	5

Barilotto Zincato Prolungato
" Scorrevole "

Codice	Riferimenti	Listino A	Listino B	Off.	Box
BZ1\2X150P	1/2"X150mm	1,21 €	1,35 €	1	5
BZ1\2X200P	1/2"X200mm	1,57 €	1,74 €	1	5
BZ3\4X150P	3/4"X150mm	1,57 €	1,74 €	1	5
BZ3\4X200P	3/4"X200mm	1,59 €	1,76 €	1	5
BZ1X150P	1"X150mm	2,13 €	2,36 €	1	5
BZ1X200P	1"X200mm	2,88 €	3,20 €	1	5
BZ11\4X150P	1 1/4"X150mm	2,96 €	3,29 €	1	5
BZ11\4X200P	1 1/4"X200mm	3,82 €	4,24 €	1	5
BZ11\2X150P	1 1/2"X150mm	3,44 €	3,82 €	1	5
BZ11\2X200P	1 1/2"X200mm	4,55 €	5,06 €	1	5
BZ2X150P	2"X150mm	4,83 €	5,36 €	1	5
BZ2X200P	2"X200mm	6,02 €	6,68 €	1	5

Barilotto Zincato
D. 1 1/4"

Codice	Riferimenti	Listino A	Listino B	Off.	Box
BZ11\4X100	1 1/4"X100mm	1,62 €	1,80 €	1	5
BZ11\4X150	1 1/4"X150mm	2,18 €	2,42 €	1	5
BZ11\4X200	1 1/4"X200mm	3,87 €	4,29 €	1	5
BZ11\4X250	1 1/4"X250mm	3,64 €	4,04 €	1	5
BZ11\4X300	1 1/4"X300mm	4,20 €	4,66 €	1	5
BZ11\4X400	1 1/4"X400mm	5,84 €	6,49 €	1	5
BZ11\4X500	1 1/4"X500mm	6,73 €	7,47 €	1	5
BZ11\4X1000	1 1/4"X1000mm	13,46 €	14,94 €	1	5



Collare Riparazione 1 Tirante

Codice	Riferimenti	Listino A	Listino B	Off.	Box
030200	21/25	9,11 €	10,11 €	1	10
030201	26/30	9,11 €	10,11 €	1	10
030202	33/37	9,56 €	10,62 €	1	10
030203	42/45	10,48 €	11,63 €	1	10
030204	48/51	10,48 €	11,63 €	1	10
030205	60/64	14,35 €	15,92 €	1	10



Collare Di Presa In A 4 Bullone 50 3/4"-1"

Codice	Riferimenti	Listino A	Listino B	Off.	Box
072030	50 3/4"-1"	37,98 €	42,16 €	1	10
072031	63 3/4"-11/4"	40,31 €	44,74 €	1	10
072032	75 3/4"-1"1/4	63,31 €	70,27 €	1	10
072033	90 1"-2"	70,59 €	78,36 €	1	10
072034	110 1"1/4-2"	84,26 €	93,52 €	1	10
072035	125 1"1/4-2"	97,92 €	108,69 €	1	10



Collare Riparazione Permanente 48/56

Codice	Riferimenti	Listino A	Listino B	Off.	Box
030220	48/56	107,03 €	118,80 €	1	1
030221	56/64	107,03 €	118,80 €	1	1
030222	60/68	109,30 €	121,33 €	1	1



Giunto Diel. Gas Pn10 1/2" Mf

Codice	Riferimenti	Listino A	Listino B	Off.	Box
GDG11/2MF	D. 1/2"	13,03 €	14,46 €	1	10
GDG3/4MF	D. 3/4"	29,17 €	32,38 €	1	10
GDG1MF	D. 1"	35,76 €	39,69 €	1	10
GDG11/4MF	D. 11/4"	47,82 €	53,08 €	1	10
GDG11/2MF	D. 11/2"	57,38 €	63,70 €	1	10
GDG2MF	D. 2"	70,67 €	78,44 €	1	10



Presse a staffa

Art. 610

REFERENZE - MISURA

C=3/8" H =1" OL = 2"
D=1/2" HB=11/4" OLD=21/2"
G= 3/4" HD=11/2" Y=3" Z=4"

Codice	Riferimenti	Listino A	Listino B	Off.	Box
610-D20	1/2"x20	1,07 €	1,19 €	1	10
610-D25	1/2"x25	1,04 €	1,15 €	1	10
610-G25	3/4"x25	1,07 €	1,19 €	1	10
610-D32	1/2"x32	1,20 €	1,33 €	1	10
610-G32	3/4"x32	1,20 €	1,33 €	1	10
610-D40	1/2"x40	1,42 €	1,57 €	1	10
610-G40	3/4"x40	1,42 €	1,57 €	1	10
610-H40	1"x40	1,39 €	1,54 €	1	10
610-D50	1/2"x50	1,92 €	2,13 €	1	10
610-G50	3/4"x50	1,70 €	1,89 €	1	10
610-H50	1"x50	1,92 €	2,13 €	1	10
610-HB50	11/4"x50	2,05 €	2,27 €	1	10
610-D63	1/2"x63	2,05 €	2,27 €	1	10
610-G63	3/4"x63	2,90 €	3,22 €	1	10
610-H63	1"x63	2,90 €	3,22 €	1	10
610-HB63	11/4"x63	2,27 €	2,52 €	1	10
610-D75	1/2"x75	2,33 €	2,59 €	1	10
610-G75	3/4"x75	2,33 €	2,59 €	1	10
610-H75	1"x75	2,33 €	2,59 €	1	10
610-HB75	11/4"x75	2,46 €	2,73 €	1	10
610-HD75	11/2"x75	2,46 €	2,73 €	1	10
610-OL75	2"x75	2,46 €	2,73 €	1	10
610-D90	1/2"x90	2,93 €	3,25 €	1	10
610-G90	3/4"x90	2,93 €	3,25 €	1	10
610-H90	1"x90	2,93 €	3,25 €	1	10
610-HB90	11/4"x90	3,18 €	3,53 €	1	10
610-HD90	11/2"x90	2,93 €	3,25 €	1	10
610-OL90	2"x90	2,93 €	3,25 €	1	10
610-D110	1/2"x110	3,62 €	4,02 €	1	10
610-G110	3/4"x110	3,62 €	4,02 €	1	10



Filtro Gas

Codice	Riferimenti	Listino A	Listino B	Off.	Box
FG11/2E	1/2"	12,65 €	14,04 €	1	10
FG3/4E	3/4"	12,65 €	14,04 €	1	10
FG1E	1"	22,32 €	24,77 €	1	10



Rubinetto Sfera Pes. Leva
1/2" Blu RS1\2P

Codice	Riferimenti	Listino A	Listino B	Off.	Box
RS1\2P	1/2"	9,60 €	10,65 €	1	12
RS3\4P	3/4"	12,60 €	13,98 €	1	8



Rubinetto Sfera Pes. 1/2"
Leva Alluminio Nera
2050N015

Codice	Riferimenti	Listino A	Listino B	Off.	Box
2050N015	1/2"	8,24 €	9,15 €	1	1



Rubinetto A Sfera Da 1/2"
RS1\2

Codice	Riferimenti	Listino A	Listino B	Off.	Box
RS1\2	1/2"	5,21 €	5,78 €	1	12
RS3\4	3/4"	8,19 €	9,10 €	1	8
RS1	1"	13,85 €	15,37 €	1	6



Rubinetto A Sfera
C/Portagomma Asta Piatta
1/2" 2060ST015

Codice	Riferimenti	Listino A	Listino B	Off.	Box
2060ST015	1/2"	5,76 €	6,39 €	1	12
2060ST020	3/4"	8,13 €	9,02 €	1	8
2060ST025	1"	14,08 €	15,63 €	1	6



Rubinetto A Sfera Doppio
Portagomma 2040ST015

Codice	Riferimenti	Listino A	Listino B	Off.	Box
2040ST015	1/2"	12,83 €	14,24 €	1	8



Rubinetto A Sfera 1/2" P
/Lucch. RS1\2L

Codice	Riferimenti	Listino A	Listino B	Off.	Box
RS1\2L	1/2"	7,53 €	8,36 €	1	12
RS3\4L	3/4"	8,90 €	9,88 €	1	8



Portagomma rapido per
Rubinetto

Codice	Riferimenti	Listino A	Listino B	Off.	Box
COD20700	1/2"	2,43 €	2,70 €	1	5



Portagomma X Rubinetto

Codice	Riferimenti	Listino A	Listino B	Off.	Box
PR1\2	1/2"	1,34 €	1,49 €	1	10
PR3\4	3/4"	2,46 €	2,73 €	1	5
PR1	1"	1,96 €	2,17 €	1	10



ROIS
Rubinetto Inox Olio Salva Gocc.
ROIS



RSO1\2
Rubinetto A Sfera Per Olio
1/2" RSO1\2

Codice	Riferimenti	Listino A	Listino B	Off.	Box
ROIS	1/2"	16,06 €	17,83 €	1	5
RSO1\2	1/2"	5,13 €	5,70 €	1	5



Valvola Mignon D. 1/2" Mf
L/Nera VM1\2N



Codice	Riferimenti	Listino A	Listino B	Off.	Box
VM1\2N	D. 1/2"	4,24 €	4,70 €	1	10
VM3\8	D. 3/8"	2,71 €	3,01 €	1	10



Valvola Mignon Cr. Esag. Mf



Valvola Mignon Ff 1/2"
L/Nera VM1\2FN



Codice	Riferimenti	Listino A	Listino B	Off.	Box
VM1\2BN	D. 1/2"	4,27 €	4,74 €	1	10
VM1\2FBN	D. 1/2"	3,61 €	4,01 €	1	10

Codice	Riferimenti	Listino A	Listino B	Off.	Box
VM1\2FN	D. 1/2"	3,74 €	4,15 €	1	10
VM3\8F	D. 3/8"	2,97 €	3,30 €	1	10



Valvola Sfera P /T Leva

Codice	Riferimenti	Listino A	Listino B	Off.	Box
VS12	1/2" FF	5,75 €	6,38 €	1	10
VS34	3/4" FF	8,69 €	9,65 €	1	10
VS1	1" FF	14,40 €	15,98 €	1	8
VS11\4	1"1/4 FF	22,94 €	25,46 €	1	6
VS11\2	1"1/2 FF	31,74 €	35,23 €	1	4
VS2	2" FF	53,33 €	59,19 €	1	2



Valvola Sfera Mf
Leva Rossa

Codice	Riferimenti	Listino A	Listino B	Off.	Box
VS12MF	1/2" MF	5,75 €	6,38 €	1	10
VS34MF	3/4" MF	8,52 €	9,46 €	1	10
VS1MF	1" MF	14,65 €	16,26 €	1	8
VS11\4MF	1"1/4 MF	22,94 €	25,46 €	1	6
VS11\2MF	1"1/2 MF	31,20 €	34,63 €	1	4
VS2MF	2" MF	53,33 €	59,19 €	1	2



Valvola 1/2" Ff A
Farfalla

Codice	Riferimenti	Listino A	Listino B	Off.	Box
VS12F	1/2" FF	5,75 €	6,38 €	1	10
VS34F	3/4" FF	8,52 €	9,46 €	1	10
VS1F	1" FF	14,41 €	16,00 €	1	8



Valvola 1/2" Mf A
Farfalla

Codice	Riferimenti	Listino A	Listino B	Off.	Box
VS12FMF	1/2" MF	6,41 €	7,12 €	1	10
VS34FMF	3/4" MF	8,68 €	9,63 €	1	10
VS1FMF	1" MF	14,65 €	16,26 €	1	8



Valvola Ad Angolo Mf

Codice	Riferimenti	Listino A	Listino B	Off.	Box
VA12	1/2" MF	8,87 €	9,85 €	1	10
VA34	3/4" MF	14,00 €	15,54 €	1	10
VA1	1" MF	22,75 €	25,25 €	1	8



Valvola Bocchettone Mf

Codice	Riferimenti	Listino A	Listino B	Off.	Box
VB12	1/2" MF	7,27 €	8,07 €	1	10
VB34	3/4" MF	11,07 €	12,29 €	1	10
VB1	1" MF	19,15 €	21,25 €	1	8



Valvola Ad Angolo Mf

Codice	Riferimenti	Listino A	Listino B	Off.	Box
VA1\2P	1/2"	9,06 €	10,05 €	1	10
VA3\4P	3/4"	14,30 €	15,87 €	1	10



Valvola A Sfera Rosso A P/
Totale Squadra Con Attacco
Girevole Portatermometro
87226AF11

Codice	Riferimenti	Listino A	Listino B	Off.	Box
87226AF11		35,02 €	38,87 €	1	10



Valvola Bocchettone Mf

Codice	Riferimenti	Listino A	Listino B	Off.	Box
VB1\2P	1/2"	7,49 €	8,31 €	1	10
VB3\4P	3/4"	11,30 €	12,54 €	1	10



Valvola A Sfera Blu A P/ Totale
Squadra Con Attacco Girevole
Portatermometro 87226AF12

Codice	Riferimenti	Listino A	Listino B	Off.	Box
87226AF12		35,02 €	38,87 €	1	10



Valvola Sfera 3 V. P/T A L
1/2" V3VL1\2



Codice	Riferimenti	Listino A	Listino B	Off.	Box
V3VL1\2	1/2" "L"	31,65 €	35,13 €	1	10
V3VL3\4	3/4" "L"	39,83 €	44,21 €	1	10



Valvola Sfera 3 V. P/T A T
1/2" V3VLT1\2



Codice	Riferimenti	Listino A	Listino B	Off.	Box
V3VLT1\2	1/2" "L"	31,65 €	35,13 €	1	10
V3VLT3\4	3/4" "L"	39,83 €	44,21 €	1	10



Valvola Tenuta Apm



Codice	Riferimenti	Listino A	Listino B	Off.	Box
VE1\2A	1/2"	6,31 €	7,00 €	1	10
VE3\4A	3/4"	10,42 €	11,57 €	1	10
VE1A	1"	15,85 €	17,59 €	1	8
VE11\4A	1"1/4	22,51 €	24,98 €	1	6
VE11\2A	1"1/2	29,84 €	33,12 €	1	4
VE2A	2"	46,43 €	51,53 €	1	2



Valvola Clapet



Codice	Riferimenti	Listino A	Listino B	Off.	Box
VC1\2	1/2"	5,31 €	5,90 €	1	10
VC3\4	3/4"	7,59 €	8,43 €	1	10
VC1	1"	12,31 €	13,66 €	1	8
VC11\4	1"1/4	18,83 €	20,90 €	1	6
VC11\2	1"1/2	28,34 €	31,46 €	1	4
VC2	2"	31,80 €	35,30 €	1	2



Valvola Tenuta Planet

Codice	Riferimenti	Listino A	Listino B	Off.	Box
VT1\2P	1/2"	3,93 €	4,37 €	1	10
VT3\4P	3/4"	5,18 €	5,75 €	1	10
VT1P	1"	8,08 €	8,97 €	1	8
VT11\4P	1"1/4	11,13 €	12,36 €	1	6
VT11\2P	1"1/2	16,87 €	18,72 €	1	4
VT2P	2"	23,62 €	26,22 €	1	2



Filtro Raccogli Impurita'

Codice	Riferimenti	Listino A	Listino B	Off.	Box
FY1\2	1/2"	3,79 €	4,21 €	1	10
FY3\4	3/4"	7,19 €	7,98 €	1	10
FY1	1"	9,44 €	10,47 €	1	8
FY11\4	1"1/4	17,28 €	19,18 €	1	6
FY11\2	1"1/2	13,75 €	15,26 €	1	4
FY2	2"	30,81 €	34,20 €	1	2

Valvola Di Fondo 1/2" Ottone
VF1\2

Codice	Riferimenti	Listino A	Listino B	Off.	Box
VF1\2	1/2"	4,76 €	5,28 €	1	10
VF3\4	3/4"	7,41 €	8,23 €	1	10
VF1	1"	9,00 €	9,99 €	1	8
VF11\4	1"1/4	14,10 €	15,65 €	1	6
VF11\2	1"1/2	17,62 €	19,56 €	1	4
VF2	2"	28,18 €	31,28 €	1	2

Cestello Valvola Di Fondo
1/2" CVF1\2

Codice	Riferimenti	Listino A	Listino B	Off.	Box
CVF1\2	1/2"	1,06 €	1,18 €	1	10
CVF3\4	3/4"	1,72 €	1,91 €	1	10
CVF1	1"	2,63 €	2,92 €	1	8
CVF11\4	1"1/4	2,19 €	2,43 €	1	6
CVF11\2	1"1/2	1,68 €	1,87 €	1	4
CVF2	2"	3,31 €	3,68 €	1	2

Valvola A Sfera Incasso 1/2"
VSI1\2E

Codice	Riferimenti	Listino A	Listino B	Off.	Box
VSI1\2E	1/2" FF	26,20 €	29,08 €	1	10
VSI3\4E	3/4" FF	47,36 €	52,57 €	1	10

Valvola Sfera Incasso F/F
Deviatore Cromata

Codice	Riferimenti	Listino A	Listino B	Off.	Box
VSI1\2	1/2" FF	17,51 €	19,43 €	1	10
VSI3\4	1/2" FF	18,74 €	20,80 €	1	10

Saracinesca Ott. Ff Pn10 1/2"
S1\2

Codice	Riferimenti	Listino A	Listino B	Off.	Box
S1\2	1/2" FF	7,55 €	8,38 €	1	10
S3\4	3/4" FF	10,12 €	11,24 €	1	10
S1	1" FF	12,56 €	13,95 €	1	8
S11\4	1"1/4 FF	21,67 €	24,05 €	1	6
S11\2	1"1/2 FF	20,08 €	22,29 €	1	4
S2	2" FF	36,73 €	40,77 €	1	2
S21\2	2 1/2" FF	68,55 €	76,09 €	1	2
S3	3" FF	93,85 €	104,18 €	1	2
S4	4" FF	158,73 €	176,20 €	1	2



Valvola Gas MF Leva Piatta

Codice	Riferimenti	Listino A	Listino B	Off.	Box
VSG1\2PMF	D. 1/2"	8,01 €	8,90 €	1	12
VSG3\4PMF	D. 3/4"	11,85 €	13,16 €	1	10
VSG1PMF	D. 1"	18,39 €	20,41 €	1	8
VSG11\4PMF	D. 1 1/4"	23,74 €	26,35 €	1	6
VSG11\2PMF	D. 1 1/2"	29,65 €	32,91 €	1	4
VSG2PMF	D. 2"	51,42 €	57,08 €	1	2



Valvola Gas FF Leva Piatta

Codice	Riferimenti	Listino A	Listino B	Off.	Box
VSG1\2P	D. 1/2"	7,63 €	8,47 €	1	12
VSG3\4P	D. 3/4"	11,51 €	12,78 €	1	10
VSG1P	D. 1"	18,39 €	20,41 €	1	8
VSG11\4P	D. 1 1/4"	23,74 €	26,35 €	1	6
VSG11\2P	D. 1 1/2"	29,65 €	32,91 €	1	4
VSG2P	D. 2"	51,42 €	57,08 €	1	2



Valvola Gas MF Leva Farfalla

Codice	Riferimenti	Listino A	Listino B	Off.	Box
VSG1\2FMF	D. 1/2"	8,01 €	8,90 €	1	12
VSG3\4FMF	D. 3/4"	11,85 €	13,16 €	1	10
VSG1FMF	D. 1"	18,39 €	20,41 €	1	8



Valvola Gas FF Leva Farfalla

Codice	Riferimenti	Listino A	Listino B	Off.	Box
VSG1\2F	D. 1/2"	7,63 €	8,47 €	1	12
VSG3\4F	D. 3/4"	11,51 €	12,78 €	1	10
VSG1F	D. 1"	19,61 €	21,77 €	1	8



Valvola Gas FF Leva Farfalla
Presa Pressione

Codice	Riferimenti	Listino A	Listino B	Off.	Box
VSG1\2FPPP	D. 1/2"	16,25 €	18,04 €	1	12
VSG3\4FPPP	D. 3/4"	23,32 €	25,89 €	1	10
VSG1FPPP	D. 1"	33,09 €	36,73 €	1	8



Rubinetto Gas Sq.
1/2" Mx1/2" F RGSMFDD

Codice	Riferimenti	Listino A	Listino B	Off.	Box
RGSMFDD	1/2"x1/2"	7,70 €	8,55 €	1	12
RGSMFDG	1/2"x3/4"	11,61 €	12,89 €	1	10



Rubinetto Gas Squadra MM

Codice	Riferimenti	Listino A	Listino B	Off.	Box
RGSMM	D. 1/2"	7,59 €	8,43 €	1	12



Rubinetto Gas Squadra M

Codice	Riferimenti	Listino A	Listino B	Off.	Box
RGS1\2MET	1/2" metano	6,05 €	6,71 €	1	12



Contatore Gas Cl.G2,5
Gpl.Met CG2,5

Codice	Riferimenti	Listino A	Listino B	Off.	Box
CG2,5	max 4 lt/h	78,44 €	87,06 €	1	1



Rubinetto Squadra M

Codice	Riferimenti	Listino A	Listino B	Off.	Box
RGS1\2GPL	1/2" gpl	Arrivo	Arrivo	1	12



Coppia Mensola C /Valv. Cont. 11/4"
Attacco Contatore Uscita 3/4" M
Entrata 3/4" F CMCG

Codice	Riferimenti	Listino A	Listino B	Off.	Box
CMCG	3/4"x1 1/4"	29,98 €	33,28 €	1	1



Guarnizione Gpl Cuoio 17X10X2
5020CUOIO

Codice	Riferimenti	Listino A	Listino B	Off.	Box
5020CUOIO	17x10x2	0,03 €	0,04 €	1	100



Nuovo Tubo Gas Rivestito 100Mm
EMITEG100

Codice	Riferimenti	Listino A	Listino B	Off.	Box
EMITEG100	cm.100	12,15 €	13,48 €	1	10
EMITEG150	cm.150	17,33 €	19,24 €	1	10
EMITEG200	cm.200	21,00 €	23,31 €	1	10
EMITEG300	cm.300	34,66 €	38,48 €	1	10



Flex Acqua Mf Da 1/2" 110/210
FA1\220

Codice	Riferimenti	Listino A	Listino B	Off.	Box
FA1\220	1/2" 10<>20	5,24 €	5,81 €	1	10
FA1\240	1/2" 20<>40	6,20 €	6,88 €	1	10
FA3\420	3/4" 10<>20	7,29 €	8,09 €	1	10
FA3\440	3/4" 20<>40	9,24 €	10,25 €	1	10

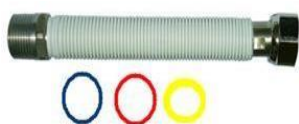

Flex Riv. Bianco 10-20 1/2"
GA1201B

Codice	Riferimenti	Listino A	Listino B	Off.	Box
GA1201B	1/2" 10<>20	6,15 €	6,82 €	1	10
GA1202B	1/2" 20<>40	7,08 €	7,86 €	1	10
GA3401B	3/4" 10<>20	8,53 €	9,46 €	1	10
GA3402B	3/4" 20<>40	9,31 €	10,34 €	1	10



Valvola Con Cassetta Gas Ispezione
1/2" F CGI1\2CR

Codice	Riferimenti	Listino A	Listino B	Off.	Box
CGI1\2CR	1/2" FF	48,65 €	54,00 €	1	4
CGI3\4CR	3/4" MM	42,19 €	46,83 €	1	4



Ecogiunto Retto Per Gas 3/4" Pe 25
034000/G

Codice	Riferimenti	Listino A	Listino B	Off.	Box
034000/G	D. 3/4"	26,42 €	29,32 €	1	1
034001/G	D. 1"	27,33 €	30,33 €	1	1
034002/G	D. 1 1/4"	31,43 €	34,88 €	1	1
034003/G	D. 1 1/2"	36,43 €	40,44 €	1	1
034004/G	D. 2"	40,08 €	44,49 €	1	1



Tubo Gas Estensibile Autoest. D. 20
Mm TGAS20E

Codice	Riferimenti	Listino A	Listino B	Off.	Box
TGAS20E	D. 20	0,73 €	0,81 €	1	50
TGAS25E	D. 25	0,81 €	0,89 €	1	50
TGAS30E	D. 30	0,98 €	1,09 €	1	25
TGAS40E	D. 40	1,59 €	1,77 €	1	25



Flex Gas Estensibile Gas D. 1/2"
100<>200 FG1\220

Codice	Riferimenti	Listino A	Listino B	Off.	Box
FG1\220	1/2" 10<>20	6,27 €	6,97 €	1	10
FG1\240	1/2" 20<>40	7,29 €	8,09 €	1	10
FG3\420	3/4" 10<>20	8,70 €	9,66 €	1	10
FG3\440	3/4" 20<>40	10,58 €	11,75 €	1	10



Kit Caldaia Universale 5 Pz 10<>20
Cm. KC

Codice	Riferimenti	Listino A	Listino B	Off.	Box
KC	Kit 10 <> 20	40,99 €	45,50 €	1	6
KCP	Kit 20 <> 40	37,73 €	41,87 €	1	6

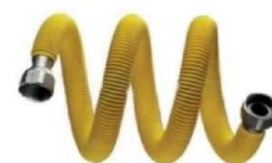

Flex Gas 75-150 Ff 1/2" FG150

Codice	Riferimenti	Listino A	Listino B	Off.	Box
FG150	75<>150	15,92 €	17,67 €	1	10



Ecogiunto Curvo Per Gas 3/4" Pe 25
034020/G

Codice	Riferimenti	Listino A	Listino B	Off.	Box
034020/G	D. 3/4"	45,54 €	50,55 €	1	1
034021/G	D. 1"	51,01 €	56,62 €	1	1
034022/G	D. 1 1/4"	63,76 €	70,77 €	1	1
034023/G	D. 1 1/2"	68,32 €	75,83 €	1	1
034024/G	D. 2"	84,71 €	94,03 €	1	1

Minicentralina Per 2 Bombole Modello Y +
Reg Bp 4Kg Con Manometro E Riduttori Di
1° E 2° Stadio (Completa Di Staffa E
Tasselli) Con Membrana In Viton + Fless
MC230212F



Codice	Riferimenti	Listino A	Listino B	Off.	Box
MC230212F	2 vie 4 KG	73,38 €	81,45 €	1	4

Riduttore Primo Stadio In Alluminio Per
Serbatoi Gpl Interrati E Fuori Terra Ad Uso
Domestico Ed Industriale Portata 40-60
Kg/H C/Manometro P.E. 16 Bar Max 1/4" F -
3/8" F (P.U.= 1-3 Bar) RGAP40M



Codice	Riferimenti	Listino A	Listino B	Off.	Box
RGAP40M	40-60 kg	50,60 €	56,17 €	1	6

Riduttore Pressione 12-14
Kg/H RGAP14M



Codice	Riferimenti	Listino A	Listino B	Off.	Box
RGAP14M	14 kg	25,81 €	28,65 €	1	6

Regolatore Gas Alta
Pressione Pesante
AP02100XZ



Codice	Riferimenti	Listino A	Listino B	Off.	Box
AP02100XZ		52,63 €	58,42 €	1	6

Regolatore 7Kg. Bp F.3/8"
RG7C



Codice	Riferimenti	Listino A	Listino B	Off.	Box
RG7C	7 kg	18,22 €	20,22 €	1	6
RG10C	10 kg	19,23 €	21,34 €	1	6

Regolatore Bassa Press.
Variab RGBPV



Codice	Riferimenti	Listino A	Listino B	Off.	Box
RGBPV	bp	3,88 €	4,30 €	1	12

Tubo Pvc X Gas Bombole Gpl
8X13 Imq rotolo Mt. 50
TGGPL



Codice	Riferimenti	Listino A	Listino B	Off.	Box
TGGPL	D. 13x8	1,13 €	1,25 €	1	50

Minicentralina Gas 2 V. Reg. 4 Kg. Con
Flessibili MCG24F



Codice	Riferimenti	Listino A	Listino B	Off.	Box
MCG24F	2 vie	39,22 €	43,53 €	1	4

Riduttore Primo Stadio In Alluminio Per
Serbatoi Gpl Interrati E Fuori Terra Ad Uso
Domestico Ed Industriale Portata 40-60
Kg/H S/Manometro
P.E. 16 Bar Max 1/4" F - 3/8" F (P.U.= 1-3
Bar) RGAP40



Codice	Riferimenti	Listino A	Listino B	Off.	Box
RGAP40	40-60 kg	43,77 €	48,59 €	1	6

Regolatore Alta Pressione
RGAP



Codice	Riferimenti	Listino A	Listino B	Off.	Box
RGAP		8,10 €	8,99 €	1	12

Ridutt. Aprn 40 Kg. 0 /3 Bar
Con Manometro RAP40M



Codice	Riferimenti	Listino A	Listino B	Off.	Box
RAP40M	40 kg	50,60 €	56,17 €	1	6

Regolatore Gas 4 Kg Entrata
Dado Ch25 Uscita G 3/8 F
RG4CD



Codice	Riferimenti	Listino A	Listino B	Off.	Box
RG4CD	4 kg	9,87 €	10,95 €	1	6

Regolatore Gas Bassa
Pressione RGBP



Codice	Riferimenti	Listino A	Listino B	Off.	Box
RGBP	bp	5,44 €	6,04 €	1	12

Tubo Pvc X Gas Metano
13X20 Imq rotolo Mt. 50
TGM



Codice	Riferimenti	Listino A	Listino B	Off.	Box
TGM	D. 20x13	1,87 €	2,08 €	1	50



Gomito M. 1/2" X Gpl
GM1\2G

Codice	Riferimenti	Listino A	Listino B	Off.	Box
GM1\2G	Gpl	2,13 €	2,36 €	1	10



Gomito M. 1/2" X Met.
GM1\2M

Codice	Riferimenti	Listino A	Listino B	Off.	Box
GM1\2M	Metano	2,55 €	2,83 €	1	10



Niples Femmina
1/2"X10 Gpl NF1\2G

Codice	Riferimenti	Listino A	Listino B	Off.	Box
NF1\2G	Gpl	1,47 €	1,63 €	1	10



Niples Maschio
1/2"X10 Gpl NM1\2G

Codice	Riferimenti	Listino A	Listino B	Off.	Box
NM1\2G		1,26 €	1,40 €	1	10



Raccordo A Gomito G
1/2" M-M RG110001

Codice	Riferimenti	Listino A	Listino B	Off.	Box
RG110001	1/2"	1,67 €	1,85 €	1	10



Niples Gialla 1/2" Ds Sx
NG1\2DS

Codice	Riferimenti	Listino A	Listino B	Off.	Box
NG1\2DD	1/2" Dx-Dx	1,87 €	2,08 €	1	10
NG1\2DS	1/2" Dx-Sx	4,43 €	4,91 €	1	10



Port. A 90° - Ø 14 Metano
Con Filetto Maschio, In Zama
G 1/2" M 1/8" F PG911406

Codice	Riferimenti	Listino A	Listino B	Off.	Box
PG911406	1/2"	1,77 €	1,97 €	1	10



Gomito F. 1/2" X Gpl
GF1\2G

Codice	Riferimenti	Listino A	Listino B	Off.	Box
GF1\2G	Gpl	1,91 €	2,12 €	1	10



Gomito F. 1/2" X Met.
GF1\2M

Codice	Riferimenti	Listino A	Listino B	Off.	Box
GF1\2M	Metano	2,23 €	2,48 €	1	10



Niples Femmina
1/2"X14 Met NF1\2M

Codice	Riferimenti	Listino A	Listino B	Off.	Box
NF1\2M	Metano	2,91 €	3,23 €	1	10



Niples Maschio
1/2"X14 Met NM1\2M

Codice	Riferimenti	Listino A	Listino B	Off.	Box
NM1\2M		1,32 €	1,46 €	1	10



Raccordo A Gomito G 1/2" M-
F Port. A 90° - Ø 14 Metano
Con Filetto Maschio, In Zama
RG100001

Codice	Riferimenti	Listino A	Listino B	Off.	Box
RG100001	1/2"	1,72 €	1,91 €	1	10



Raccordo A "Y" Gpl
RYGPL

Codice	Riferimenti	Listino A	Listino B	Off.	Box
RYMET	Metano	3,80 €	4,21 €	1	10
RYGPL	Gpl	0,96 €	1,07 €	1	10



Raccordo M.1/4" Dado
Mm 25 147.010

Codice	Riferimenti	Listino A	Listino B	Off.	Box
147.010		2,45 €	2,72 €	1	10



Tubo rame 373 x 1

Codice	Riferimenti	U.M.	Conf.	Listino A	Listino B
SO10	D. 10x1	Mt.	50	Controllare prezzo si excel	
SO12	D. 12x1	Mt.	50	Controllare prezzo si excel	
SO14	D. 14x1	Mt.	50	Controllare prezzo si excel	
SO16	D. 16x1	Mt.	50	Controllare prezzo si excel	
SO18	D. 18x1	Mt.	25	Controllare prezzo si excel	
SO22	D. 22x1	Mt.	25	Controllare prezzo si excel	



Tubo rame 373 x 0,8

Codice	Riferimenti	U.M.	Conf.	Listino A	Listino B
S810	D. 10x0,8	Mt.	50	Controllare prezzo si excel	
S812	D. 12x0,8	Mt.	50	Controllare prezzo si excel	
S814	D. 14x0,8	Mt.	50	Controllare prezzo si excel	
S816	D. 16x0,8	Mt.	50	Controllare prezzo si excel	
S818	D. 18x0,8	Mt.	25	Controllare prezzo si excel	
S822	D. 22x0,8	Mt.	25	Controllare prezzo si excel	



Tubo rame Pvc

Codice	Riferimenti	U.M.	Conf.	Listino A	Listino B
S10P	D. 10x1	Mt.	50	Controllare prezzo si excel	
S12P	D. 12x1	Mt.	50	Controllare prezzo si excel	
S14P	D. 14x1	Mt.	50	Controllare prezzo si excel	
S16P	D. 16x1	Mt.	50	Controllare prezzo si excel	
S18P	D. 18x1	Mt.	25	Controllare prezzo si excel	
S22P	D. 22x1	Mt.	25	Controllare prezzo si excel	



Tubo rame gas stellare

Codice	Riferimenti	U.M.	Conf.	Listino A	Listino B
SGS12	D. 12x1	Mt.	50	Controllare prezzo si excel	
SGS14	D. 14x1	Mt.	50	Controllare prezzo si excel	
SGS16	D. 16x1	Mt.	50	Controllare prezzo si excel	
SGS18	D. 18x1	Mt.	25	Controllare prezzo si excel	
SGS22	D. 22x1	Mt.	25	Controllare prezzo si excel	



Rame a Barre da 5 mt.

Codice	Riferimenti	U.M.	Conf.	Listino A	Listino B
V10S	10X1	Mt.	5	Controllare prezzo si excel	
V12S	12X1	Mt.	5	Controllare prezzo si excel	
V14S	14X1	Mt.	5	Controllare prezzo si excel	
V16S	16X1	Mt.	5	Controllare prezzo si excel	
V18S	18X1	Mt.	5	Controllare prezzo si excel	
V22S	22X1	Mt.	5	Controllare prezzo si excel	
V28S	28X1	Mt.	5	Controllare prezzo si excel	
V35S	35X1	Mt.	5	Controllare prezzo si excel	
V42S	42X1	Mt.	5	Controllare prezzo si excel	
V54X1,5S	54X1,5	Mt.	5	Controllare prezzo si excel	



Barra Isolante Mt 2

Codice	Riferimenti	U.M.	Q.tà	Listino A	Listino B
I16X6	16x6 mm	Mt	2	0,95 €	1,06 €
I18X6	18x6 mm	Mt	2	0,79 €	0,88 €
I22X6	22x6 mm	Mt	2	0,84 €	0,93 €
I28X6	28x6 mm	Mt	2	1,14 €	1,26 €
I35X6	35x6 mm	Mt	2	1,16 €	1,29 €
I42X6	42x6 mm	Mt	2	1,51 €	1,68 €
I16X9	16x9 mm	Mt	2	1,16 €	1,29 €
I18X9	18x9 mm	Mt	2	2,16 €	2,40 €
I22X9	22x9 mm	Mt	2	2,20 €	2,44 €
I28X9	28x9 mm	Mt	2	3,06 €	3,40 €
I35X9	35x9 mm	Mt	2	3,29 €	3,65 €
I42X9	42x9 mm	Mt	2	3,80 €	4,22 €
I54X9	54x9 mm	Mt	2	4,88 €	5,42 €
I16X13	16x13 mm	Mt	2	1,63 €	1,81 €
I18X13	18x13 mm	Mt	2	1,70 €	1,89 €
I22X13	22x13 mm	Mt	2	1,79 €	1,99 €
I28X13	28x13 mm	Mt	2	2,10 €	2,33 €
I35X13	35x13 mm	Mt	2	2,54 €	2,82 €
I42X13	42x13 mm	Mt	2	3,00 €	3,33 €
I54X13	54x13 mm	Mt	2	4,01 €	4,45 €



Nastro Neoprene MI 10 Zz
NNA

Codice	Riferimenti	Listino A	Listino B	Off.	Box
NNA	10 ml	3,62 €	4,02 €	1	24



Lega Saldante Cu-P-Ag.
2%Corac PK2

Codice	Riferimenti	Listino A	Listino B	Off.	Box
PK2	CU-P-AG.2%	52,48 €	58,25 €	1	24
PK5	CU-P-AG.5%	86,71 €	96,25 €	1	24



Rotolo Lega Saldante Corac
L-1000

Codice	Riferimenti	Listino A	Listino B	Off.	Box
L-1000		39,34 €	43,67 €	1	24



Disossidante 60W Corac
60W

Codice	Riferimenti	Listino A	Listino B	Off.	Box
60W	Barattolo	3,74 €	4,16 €	1	24



Scopri di più



Codice	Riferimenti	U.M.	Q.tà	Listino A	Listino B
RC1\4	1\4X0,8 MM 6,35	Mt.	50	Vedi foglio commissione excel	
RC3\8	3\8X0,8 MM 9,52	Mt.	50	Vedi foglio commissione excel	
RC1\2	1\2X0,8 MM 12,7	Mt.	50	Vedi foglio commissione excel	



Codice	Riferimenti	U.M.	Q.tà	Listino A	Listino B
RC1\4X1	1\4X1 MM 6,35	Mt.	50	Vedi foglio commissione excel	
RC3\8x1	3\8X1 MM 9,52	Mt.	50	Vedi foglio commissione excel	
RC1\2x1	1\2X1 MM 12,7	Mt.	50	Vedi foglio commissione excel	
RC5\8x1	5\8X1 MM 15,87	Mt.	25	Vedi foglio commissione excel	
RC3\4x1	3\4X1 MM 19,05	Mt.	25	Vedi foglio commissione excel	
RC7\8x1	7\8X1 MM 22,22	Mt.	25	Vedi foglio commissione excel	



Nastro Neoprene Armaflex
Xg MI 15 XG-TAPE

Codice	Riferimenti	Listino A	Listino B	Off.	Box
XG-TAPE	15 ml	9,87 €	10,96 €	1	24



Nastro In Alluminio H50
MI50 NA50

Codice	Riferimenti	Listino A	Listino B	Off.	Box
NA50	mt. 50	9,84 €	10,93 €	1	24



Benda Vinilica Bianca H.10
25M RBVB

Codice	Riferimenti	Listino A	Listino B	Off.	Box
RBVB	Bianco	4,13 €	4,59 €	1	24
RBVR	Rosso	4,38 €	4,87 €	1	24
RBVBLU	Blu	4,38 €	4,87 €	1	24
RBVGC	Grigio Chiaro	4,38 €	4,87 €	1	24



Tubo Multistrato "373"
Rivestito



TM16X2EB
TM20X2EB
TM26X3EB
TM32X3EB



TM16X2ER
TM20X2ER
TM26X3ER
TM32X3ER

Codice	Riferimenti	Listino A	Listino B	Off.	Mt
TM16X2E	16X2X0,2	1,80 €	2,00 €	1	50
TM20X2E	20X2X0,2	2,07 €	2,29 €	1	50
TM26X3E	26X3X0,3	5,03 €	5,59 €	1	2
TM32X3E	32X3X0,3	8,47 €	9,40 €	1	25

Tubo Multistrato A Barre Prezzo Al Mt tubo 4 mt



Codice	Riferimenti	Listino A	Listino B	Off.	Mt
MTNU200B	20x2	1,83 €	2,03 €	1	4
MTNU260B	26x3	3,43 €	3,81 €	1	4
MTNU320B	32x3	5,19 €	5,76 €	1	4
MTNU400B	40x3,5	20,91 €	23,21 €	1	4



Collettore Inclinato D. 3/4"
MF uscita 1/2" M tasca D. 16

Codice	Riferimenti	Listino A	Listino B	Off.	Box
CI2A	2 vie	9,36 €	10,38 €	1	12
CI3A	3 vie	14,04 €	15,58 €	1	12
CI4A	4 vie	18,71 €	20,77 €	1	12
CI5A	5 vie	21,33 €	23,68 €	1	12



Cassette per Collettori

Codice	Riferimenti	Listino A	Listino B	Off.	Box
C3024	300X240X80	14,97 €	16,62 €	1	24
C4024	400X240X80	17,70 €	19,64 €	1	24
C5024	500X240X80	21,84 €	24,24 €	1	24
C6024	600X240X80	25,10 €	27,86 €	1	24



Tubo Multistrato Pex 16X2



PROMO

Codice	Riferimenti	Listino A	Listino B	Off.	Mt
TM16X2	16X2X0,2	1,27 €	1,41 €	1	100
TM20X2	20X2X0,2	1,62 €	1,80 €	1	100
TM26X3	26X3X0,3	3,11 €	3,45 €	1	50
TM32X3	32X3X0,3	4,76 €	5,28 €	1	25



Tubo Multistrato "373"
Rivestito Refrigerazione

Codice	Riferimenti	Listino A	Listino B	Off.	Mt
TM16X2EF	16X2-Isolante 13	2,46 €	2,73 €	1	50
TM20X2EF	20X2-Isolante 13	2,91 €	3,23 €	1	50
TM26X3EF	26X3-Isolante 13	5,18 €	5,75 €	1	25
TM32X3EF	32X3-Isolante 13	9,08 €	10,08 €	1	25



Tubo Multistrato "373"
Rivestito Gas

Codice	Riferimenti	Listino A	Listino B	Off.	Mt
TM16X2G	16X2X0,3	3,03 €	3,36 €	1	50
TM20X2G	20X2X0,4	4,01 €	4,45 €	1	50
TM26X3G	26X3X0,6	7,49 €	8,32 €	1	25



Collettore Angolo D. 3/4" MF
uscita 1/2" M tasca D. 16

Codice	Riferimenti	Listino A	Listino B	Off.	Box
C1\212	2 vie	14,41 €	15,99 €	1	12
C1\213	3 vie	21,61 €	23,99 €	1	12
C1\214	4 vie	28,81 €	31,98 €	1	12



Inserto 1/2 Icma Art. 415 Da
Mettere Nei Collettori Per Una Sede
Piana C59415AD01

Codice	Riferimenti	Listino A	Listino B	Off.	Box
C59415AD01	1/2"x16	1,17 €	1,30 €	1	12



Collettore senza chiusura
3/4" MF uscita 1/2" M tasca
D. 16

Codice	Riferimenti	Listino A	Listino B	Off.	Box
CS2V3\4X1\2	2 vie	5,82 €	6,46 €	1	12
CS3V3\4X1\2	3 vie	8,73 €	9,69 €	1	12
CS4V3\4X1\2	4 vie	11,64 €	12,92 €	1	12

Collettore MF 1" Uscita D. 1/2"

Codice	Riferimenti	Listino A	Listino B	Off.	Box
CS2V1X1\2	2 vie	9,65 €	10,71 €	1	12
CS3V1X1\2	3 vie	12,61 €	14,00 €	1	12
CS4V1X1\2	4 vie	15,15 €	16,82 €	1	12

Collettore MF 1 1/4" Uscita D. 1/2"

Codice	Riferimenti	Listino A	Listino B	Off.	Box
CS2V11\4X1\2	2 vie	13,12 €	14,56 €	1	12
CS3V11\4X1\2	3 vie	18,79 €	20,86 €	1	12
CS4V11\4X1\2	4 vie	24,48 €	27,17 €	1	12



Kit Dado Completo 1/2" X 10
KCD10

Codice	Riferimenti	Listino A	Listino B	Off.	Box
KCD10	1/2"xRame 10	1,73 €	1,92 €	1	24
KCD12	1/2"xRame 12	1,73 €	1,92 €	1	24



Kit Completo X V+D 22-24-19
X 10 KC10

Codice	Riferimenti	Listino A	Listino B	Off.	Box
KC10	22-24x10	1,25 €	1,39 €	1	24
KC12	22-24x12	2,15 €	2,38 €	1	24
KC14	22-24x14	1,25 €	1,39 €	1	24
KC16	22-24x16	1,25 €	1,39 €	1	24



Monocono 3/8"X10 P.T.F.E.
12X10 M3\8X10

Codice	Riferimenti	Listino A	Listino B	Off.	Box
M3\8X10	3/8"X10	0,40 €	0,45 €	1	24
M1\2X12	1/2"X12	0,44 €	0,49 €	1	24
M1\2X14	1/2"X14	0,48 €	0,53 €	1	24
M1\2X10	1/2"X10	0,54 €	0,59 €	1	24



Raccordo Retto Quick per
attacco rapido multistrato

Codice	Riferimenti	Listino A	Listino B	Off.	Box
RQ16B	D. 16	1,49 €	1,66 €	1	24
RQ20R	D. 20	2,28 €	2,53 €	1	24



Collettore Barra

Codice	Riferimenti	Listino A	Listino B	Off.	Box
CB2GD	2 vie	5,87 €	6,52 €	1	10
CB3GD	3 vie	8,78 €	9,75 €	1	10
CB4GD	4 vie	11,61 €	12,89 €	1	10
CB5GD	5 vie	14,50 €	16,09 €	1	10
CB6GD	6 vie	17,41 €	19,32 €	1	10
CB7GD	7 vie	20,24 €	22,47 €	1	10
CB8GD	8 vie	23,08 €	25,61 €	1	10
CB9GD	9 vie	25,96 €	28,82 €	1	10
CB10GD	10 vie	28,74 €	31,90 €	1	10
CB11GD	11 vie	31,27 €	34,71 €	1	10
CB12GD	12 vie	34,16 €	37,91 €	1	10

Collettore FF 1" Uscita D. 1/2"

Codice	Riferimenti	Listino A	Listino B	Off.	Box
CB2HD	2 vie	6,96 €	7,72 €	1	10
CB3HD	3 vie	10,35 €	11,49 €	1	10
CB4HD	4 vie	13,61 €	15,11 €	1	10
CB5HD	5 vie	17,31 €	19,21 €	1	10
CB6HD	6 vie	20,55 €	22,81 €	1	10
CB7HD	7 vie	23,96 €	26,60 €	1	10
CB8HD	8 vie	27,30 €	30,30 €	1	10
CB9HD	9 vie	29,70 €	32,97 €	1	10
CB10HD	10 vie	33,12 €	36,76 €	1	10
CB11HD	11 vie	36,21 €	40,19 €	1	10
CB12HD	12 vie	41,47 €	46,03 €	1	10

Collettore FF 1 1/4" Uscita D. 1/2"

Codice	Riferimenti	Listino A	Listino B	Off.	Box
CB2HBD	2 vie	8,45 €	9,38 €	1	10
CB3HBD	3 vie	12,25 €	13,59 €	1	10
CB4HBD	4 vie	16,37 €	18,17 €	1	10
CB5HBD	5 vie	20,75 €	23,03 €	1	10
CB6HBD	6 vie	24,67 €	27,38 €	1	10
CB7HBD	7 vie	29,10 €	32,30 €	1	10
CB8HBD	8 vie	33,25 €	36,90 €	1	10
CB9HBD	9 vie	37,80 €	41,96 €	1	10
CB10HBD	10 vie	41,87 €	46,48 €	1	10
CB11HBD	11 vie	48,25 €	53,56 €	1	10
CB12HBD	12 vie	52,88 €	58,70 €	1	10



Dado Di Serraggio 10 (3/8")
D10

Codice	Riferimenti	Listino A	Listino B	Off.	Box
D10	3/8X3/8X10	0,83 €	0,92 €	1	24
D12	3/8X3/8X12	0,75 €	0,83 €	1	24
D12R	1/2X1/2X12	1,14 €	1,26 €	1	24
D14	1/2X1/2X14	0,83 €	0,92 €	1	24
D16	1/2X1/2X16	0,83 €	0,92 €	1	24
D18	3/4X3/4X18	1,28 €	1,43 €	1	24
D22	22X22	1,94 €	2,15 €	1	24



Gomito Femmina
bicono con ogiva in
teflon serie eco

Codice	Riferimenti	Listino A	Listino B	Off.	Box
GF3\8X10	3/8X3/8X10	3,52 €	3,91 €	1	10
GF3\8X12	3/8X3/8X12	3,52 €	3,90 €	1	10
GF3\8X14	3/8X1/2X14	0,00 €	0,00 €	1	10
GF1\2X10	1/2X3/8X10	5,74 €	6,37 €	1	10
GF1\2X12	1/2X1/2X12	3,50 €	3,88 €	1	10
GF1\2X14	1/2X1/2X14	3,13 €	3,48 €	1	10
GF1\2X16	1/2X1/2X16	3,13 €	3,47 €	1	10
GF1\2X18	1/2X3/4X18	4,88 €	5,41 €	1	10
GF3\4X12	3/4X1/2X12	7,95 €	8,82 €	1	10
GF3\4X14	3/4X1/2X14	7,88 €	8,75 €	1	10
GF3\4X16	3/4X1/2X16	5,67 €	6,29 €	1	10
GF3\4X18	3/4X3/4X18	8,03 €	8,91 €	1	10
GF3\4X22	3/4X22	5,61 €	6,22 €	1	10



Gomito Maschio
bicono con ogiva in
teflon serie eco

Codice	Riferimenti	Listino A	Listino B	Off.	Box
GM3\4X14	3/4X1/2X14	5,76 €	6,39 €	1	10
GM3\4X16	3/4X1/2X16	5,61 €	6,22 €	1	10
GM3\4X22	3/4X22	6,96 €	7,73 €	1	10



Gomito Flangiato
bicono con ogiva in
teflon serie eco

Codice	Riferimenti	Listino A	Listino B	Off.	Box
GFL1\2X12	1/2X1/2X12	3,75 €	4,16 €	1	10
GFL1\2X14	1/2X1/2X14	3,87 €	4,29 €	1	10
GFL1\2X16	1/2X1/2X16	3,87 €	4,29 €	1	10



Gomito Doppio bicono
con ogiva in teflon serie
eco

Codice	Riferimenti	Listino A	Listino B	Off.	Box
G10	3/8X3/8X10	4,91 €	5,45 €	1	10
G12	3/8X3/8X12	4,91 €	5,45 €	1	10
G12R	1/2X1/2X12	4,81 €	5,34 €	1	10
G14	1/2X1/2X14	3,85 €	4,28 €	1	10
G16	1/2X1/2X16	3,85 €	4,28 €	1	10
G18	3/4X3/4X18	6,52 €	7,24 €	1	10
G22	22X22	7,50 €	8,32 €	1	10



Niples Doppio bicono
con ogiva in teflon serie
eco

Codice	Riferimenti	Listino A	Listino B	Off.	Box
N10	3/8X3/8X10	2,33 €	2,59 €	1	10
N12	3/8X3/8X12	2,56 €	2,84 €	1	10
N12R	1/2X1/2X12	3,09 €	3,43 €	1	10
N14	1/2X1/2X14	2,87 €	3,18 €	1	10
N16	1/2X1/2X16	2,87 €	3,18 €	1	10
N18	3/4X3/4X18	5,27 €	5,85 €	1	10
N22	22X22	5,90 €	6,55 €	1	10



Tee bicono tre lati con
ogiva in teflon serie eco

Codice	Riferimenti	Listino A	Listino B	Off.	Box
T10	3/8X3/8X10	6,96 €	7,73 €	1	10
T12	3/8X3/8X12	5,76 €	6,40 €	1	10
T12R	1/2X1/2X12	5,40 €	5,99 €	1	10
T14	1/2X1/2X14	5,34 €	5,93 €	1	10
T16	1/2X1/2X16	5,27 €	5,85 €	1	10
T18	3/4X3/4X18	8,63 €	9,58 €	1	10
T22	22X22x22	10,81 €	12,00 €	1	10



Tee bicono centrale
femmina con ogiva in
teflon serie eco

Codice	Riferimenti	Listino A	Listino B	Off.	Box
TF12	1/2X1/2X12	4,90 €	5,44 €	1	10
TF14	1/2X1/2X14	4,78 €	5,31 €	1	10
TF16	1/2X1/2X16	4,73 €	5,25 €	1	10
TF18	3/4X3/4X18	9,75 €	10,82 €	1	10
TF22	22X3/4x22	9,37 €	10,40 €	1	10



Nipples Femmina
Bicono Ogiva PTFE

Codice	Riferimenti	Listino A	Listino B	Off.	Box
NF3\8X10	3/8X3/8X10	2,09 €	2,32 €	1	10
NF3\8X12	3/8X3/8X12	2,09 €	2,32 €	1	10
NF3\8X14	3/8X1/2X14	2,51 €	2,78 €	1	10
NF1\2X10	1/2X3/8X10	2,48 €	2,76 €	1	10
NF1\2X12	1/2X1/2X12	2,30 €	2,55 €	1	10
NF1\2X14	1/2X1/2X14	2,23 €	2,48 €	1	10
NF1\2X16	1/2X1/2X16	2,23 €	2,48 €	1	10
NF1\2X18	1/2X3/4X18	4,25 €	4,72 €	1	10
NF3\4X12	3/4X1/2X12	3,30 €	3,66 €	1	10
NF3\4X14	3/4X1/2X14	3,30 €	3,66 €	1	10
NF3\4X16	3/4X1/2X16	3,56 €	3,95 €	1	10
NF3\4X18	3/4X3/4X18	3,56 €	3,95 €	1	10
NF3\4X22	3/4X22	4,62 €	5,13 €	1	10
NF1X22	1"X22	6,05 €	6,72 €	1	10



Nipples Maschio
Bicono Ogiva PTFE

Codice	Riferimenti	Listino A	Listino B	Off.	Box
NM3\8X10	3/8X3/8X10	1,83 €	2,03 €	1	10
NM3\8X12	3/8X3/8X12	1,64 €	1,82 €	1	10
NM3\8X14	3/8X1/2X14	2,08 €	2,31 €	1	10
NM1\2X10	1/2X3/8X10	2,04 €	2,26 €	1	10
NM1\2X12	1/2X1/2X12	2,23 €	2,48 €	1	10
NM1\2X14	1/2X1/2X14	2,04 €	2,26 €	1	10
NM1\2X16	1/2X1/2X16	1,99 €	2,21 €	1	10
NM1\2X18	1/2X3/4X18	3,45 €	3,83 €	1	10
NM3\4X12	3/4X1/2X12	3,56 €	3,95 €	1	10
NM3\4X14	3/4X1/2X14	2,72 €	3,02 €	1	10
NM3\4X16	3/4X1/2X16	2,72 €	3,02 €	1	10
NM3\4X18	3/4X3/4X18	3,61 €	4,00 €	1	10
NM3\4X22	3/4X22	4,38 €	4,87 €	1	10
NM1X22	1"X22	5,38 €	5,98 €	1	10



Dado Di Serraggio 10 (3/8")
D10

Codice	Riferimenti	Listino A	Listino B	Off.	Box
D10	3/8X3/8X10	0,83 €	0,92 €	1	24
D12	3/8X3/8X12	0,75 €	0,83 €	1	24
D12R	1/2X1/2X12	1,14 €	1,26 €	1	24
D14	1/2X1/2X14	0,83 €	0,92 €	1	24
D16	1/2X1/2X16	0,83 €	0,92 €	1	24
D18	3/4X3/4X18	1,28 €	1,43 €	1	24
D22	22X22	1,94 €	2,15 €	1	24



Croce Bicono 4 Lati
Bicono Ogiva PTFE

Codice	Riferimenti	Listino A	Listino B	Off.	Box
C16	1/2X1/2X16	16,88 €	18,74 €	1	10



Monocono 3/8"X10 P.T.F.E.
12X10 M3\8X10

Codice	Riferimenti	Listino A	Listino B	Off.	Box
M3\8X10	3/8"X10	0,40 €	0,45 €	1	24
M1\2X12	1/2"X12	0,44 €	0,49 €	1	24
M1\2X14	1/2"X14	0,48 €	0,53 €	1	24
M1\2X10	1/2"X10	0,54 €	0,59 €	1	24



Anima Di Rinforzo

Codice	Riferimenti	Listino A	Listino B	Off.	Box
A10	D. 10	0,09 €	0,10 €	1	10
A12	D. 12	0,18 €	0,20 €	1	10
A14	D. 14	0,18 €	0,20 €	1	10
A16	D. 16	0,73 €	0,81 €	1	10
A18	D. 18	0,90 €	1,00 €	1	10
A22	D. 22	1,06 €	1,18 €	1	10



Ogiva Teflon P.T.F.E.

Codice	Riferimenti	Listino A	Listino B	Off.	Box
OT10	3/8X3/8X10	0,21 €	0,24 €	1	50
OT12	3/8X3/8X12	0,28 €	0,31 €	1	50
OT12R	1/2X1/2X12	0,45 €	0,50 €	1	50
OT14	1/2X1/2X14	0,45 €	0,50 €	1	50
OT16	1/2X1/2X16	0,45 €	0,50 €	1	50
OT18	3/4X3/4X18	0,61 €	0,67 €	1	50
OT22	22X22	0,69 €	0,77 €	1	50



Ogiva In Ottone

Codice	Riferimenti	Listino A	Listino B	Off.	Box
OO10	3/8X3/8X10	0,35 €	0,39 €	1	50
OO12	3/8X3/8X12	0,37 €	0,41 €	1	50
OO14	1/2X1/2X14	0,45 €	0,50 €	1	50
OO16	1/2X1/2X16	0,58 €	0,64 €	1	50
OO18	3/4X3/4X18	0,65 €	0,73 €	1	50
OO22	22X22	0,58 €	0,64 €	1	50

Raccordi a compressione in ottone - Tenuta O-Ring



1 - Terminale di giunzione



2 - Tubo: taglio



3 - Tubo: sbavatura



4 - Accoppiamento Acqua



5 - Accoppiamento Gas



6 - Giunzione finita

Guida all'installazione

Conex | Bänninger

Conex O-Ring



Nipples Doppia Con Oring D. 10 IG30110

Codice	Riferimenti	Listino A	Listino B	Off.	Box
IG30110	D. 10	2,68 €	2,97 €	1	10
IG30112	D. 12	3,28 €	3,64 €	1	10
IG30114	D. 14	3,68 €	4,08 €	1	10
IG30116	D. 16	4,41 €	4,89 €	1	10
IG30118	D. 18	5,11 €	5,67 €	1	10
IG30122	D. 22	8,20 €	9,10 €	1	10
IG30128	D. 28	10,66 €	11,83 €	1	10



Tee 3 Lati Con Oring D. 10 IG60110

Codice	Riferimenti	Listino A	Listino B	Off.	Box
IG60110	D. 10	6,56 €	7,28 €	1	10
IG60112	D. 12	5,83 €	6,47 €	1	10
IG60114	D. 14	6,56 €	7,28 €	1	10
IG60116	D. 16	8,11 €	9,00 €	1	10
IG60118	D. 18	10,38 €	11,53 €	1	10
IG60122	D. 22	15,67 €	17,39 €	1	10
IG60128	D. 28	18,22 €	20,22 €	1	10



Nipples Maschio Con Oring D. 3/8"X12 IG302C12

Codice	Riferimenti	Listino A	Listino B	Off.	Box
IG302C12	3/8"X12	1,91 €	2,12 €	1	10
IG302D12	1/2"X12	1,90 €	2,11 €	1	10
IG302C14	3/8"X14	1,91 €	2,12 €	1	10
IG302D14	1/2"X14	2,17 €	2,41 €	1	10
IG302G14	3/4"X14	3,23 €	3,59 €	1	10
IG302D16	1/2"X16	2,53 €	2,81 €	1	10
IG302G16	3/4"X16	3,78 €	4,20 €	1	10
IG302D18	1/2"X18	3,30 €	3,66 €	1	10
IG302G18	3/4"X18	3,47 €	3,85 €	1	10
IG302H18	1"X18	7,79 €	8,64 €	1	10
IG302G22	3/4"X22	5,08 €	5,64 €	1	10
IG302H22	1"X22	6,68 €	7,41 €	1	10
IG302G28	3/4"X28	8,11 €	9,00 €	1	10
IG302H28	1"X18	8,11 €	9,00 €	1	10



Nipples Femmina Con Oring D. 3/8"X12 IG303C12

Codice	Riferimenti	Listino A	Listino B	Off.	Box
IG303C12	3/8"X12	2,79 €	3,09 €	1	10
IG303D12	1/2"X12	2,30 €	2,55 €	1	10
IG303C14	3/8"X14	3,19 €	3,54 €	1	10
IG303D14	1/2"X14	2,39 €	2,65 €	1	10
IG303G14	3/4"X14	3,78 €	4,20 €	1	10
IG303D16	1/2"X16	3,19 €	3,54 €	1	10
IG303G16	3/4"X16	4,04 €	4,48 €	1	10
IG303D18	1/2"X18	3,55 €	3,94 €	1	10
IG303G18	3/4"X18	4,04 €	4,48 €	1	10
IG303H18	1"X18	8,72 €	9,68 €	1	10
IG303G22	3/4"X22	5,19 €	5,76 €	1	10
IG303H22	1"X22	7,20 €	7,99 €	1	10
IG303G28	3/4"X28	8,93 €	9,91 €	1	10
IG303H28	1"X18	8,93 €	9,91 €	1	10



Tee 3 Lati Con Oring D. 10 IG60110

Codice	Riferimenti	Listino A	Listino B	Off.	Box
IG60110	D. 10	6,56 €	7,28 €	1	10
IG60112	D. 12	5,83 €	6,47 €	1	10
IG60114	D. 14	6,56 €	7,28 €	1	10
IG60116	D. 16	8,11 €	9,00 €	1	10
IG60118	D. 18	10,38 €	11,53 €	1	10
IG60122	D. 22	15,67 €	17,39 €	1	10
IG60128	D. 28	18,22 €	20,22 €	1	10



Tee 2 Lati Bicono F. Centrale Con Oring D. 1/2"X12 IG617D12

Codice	Riferimenti	Listino A	Listino B	Off.	Box
IG617D12	1/2"X12	6,10 €	6,77 €	1	10
IG617D14	1/2"X14	6,65 €	7,38 €	1	10
IG617D16	1/2"X16	8,20 €	9,10 €	1	10
IG617D18	1/2"X18	9,11 €	10,11 €	1	10
IG617G18	3/4"X18	11,20 €	12,44 €	1	10
IG617G22	3/4"X22	13,94 €	15,47 €	1	10
IG617H28	1"X28	13,94 €	15,47 €	1	10



Gomito Bicono Maschio Con
Oring D. 1/2"X12 IG402D12

Codice	Riferimenti	Listino A	Listino B	Off.	Box
IG402D12	1/2"X12	3,30 €	3,66 €	1	10
IG402C12	3/8"X12	4,08 €	4,53 €	1	10
IG402D14	1/2"X14	3,46 €	3,84 €	1	10
IG402G14	3/4"X14	5,19 €	5,76 €	1	10
IG402D16	1/2"X16	4,19 €	4,65 €	1	10
IG402G16	3/4"X16	5,47 €	6,07 €	1	10
IG402D18	1/2"X18	5,70 €	6,33 €	1	10
IG402G18	3/4"X18	5,37 €	5,97 €	1	10
IG402H28	1"X18	15,21 €	16,88 €	1	10
IG402G22	3/4"X22	8,95 €	9,94 €	1	10
IG402H28	1"X28	15,21 €	16,88 €	1	10



Gomito Femmina Con Oring
D. 1/2"X12 IG403D12

Codice	Riferimenti	Listino A	Listino B	Off.	Box
IG403D12	1/2"X12	3,64 €	4,04 €	1	10
IG403C12	3/8"X12	4,10 €	4,55 €	1	10
IG403D14	1/2"X14	3,61 €	4,00 €	1	10
IG403G14	3/4"X14	5,78 €	6,42 €	1	10
IG403D16	1/2"X16	4,51 €	5,00 €	1	10
IG403G16	3/4"X16	6,19 €	6,88 €	1	10
IG403D18	1/2"X18	6,38 €	7,08 €	1	10
IG403G18	3/4"X18	5,21 €	5,79 €	1	10
IG403H28	1"X18	15,21 €	16,88 €	1	10
IG403G22	3/4"X22	8,77 €	9,74 €	1	10
IG403H28	1"X28	15,21 €	16,88 €	1	10



Gomito Femmina Con Oring
D. 1/2"X12 IG403D12

Codice	Riferimenti	Listino A	Listino B	Off.	Box
IG403D12	1/2"X12	3,64 €	4,04 €	1	10
IG403D14	1/2"X14	3,61 €	4,00 €	1	10
IG403D16	1/2"X16	4,51 €	5,00 €	1	10
IG403D18	1/2"X18	6,38 €	7,08 €	1	10

Conex O-Ring



O-Ring Di Tenuta In Epdm D.
10 IG00310

Codice	Riferimenti	Listino A	Listino B	Off.	Box
IG00310	D. 10	0,20 €	0,22 €	1	10
IG00312	D. 12	0,20 €	0,22 €	1	10
IG00314	D. 14	0,21 €	0,23 €	1	10
IG00316	D. 16	0,25 €	0,27 €	1	10
IG00318	D. 18	0,26 €	0,29 €	1	10
IG00322	D. 22	0,27 €	0,30 €	1	10
IG00328	D. 28	0,58 €	0,65 €	1	10



O-Ring Di Tenuta In Hnbr D.
10 IG00410

Codice	Riferimenti	Listino A	Listino B	Off.	Box
IG00410	D. 10	0,35 €	0,38 €	1	10
IG00412	D. 12	0,40 €	0,44 €	1	10
IG00414	D. 14	0,37 €	0,41 €	1	10
IG00416	D. 16	0,43 €	0,48 €	1	10
IG00418	D. 18	0,45 €	0,50 €	1	10
IG00422	D. 22	0,67 €	0,74 €	1	10
IG00428	D. 28	0,87 €	0,96 €	1	10

Informazioni Tecniche e Applicazioni

Conformi alle norme	UNI EN 1254-2, UNI EN 1254-4
Idonei per accoppiamento con tubi di rame secondo	UNI EN 1057 sia in verghe (R290 o R250) che in rotoli (R220)
Idonei per accoppiamento con tubi di Acciaio INOX secondo	EN10312
Idonei per accoppiamento con tubi di Acciaio al Carbonio secondo	EN10305-3
Terminali filettati secondo	UNI EN 10226-1
Materiali costruttivi	Ottone CW617N-DW, O-Ring EPDM nero secondo EN681-1, O-Ring HNBR giallo secondo EN549
Idonea per contatto con sostanze destinate al consumo umano	Sì
Idonea per installazioni negli impianti idrotermosanitari, circuito sanitario	Sì
Idonea per installazioni negli impianti di riscaldamento, raffrescamento ad acqua refrigerata (Chiller)	Sì
Idonea per installazioni negli impianti di trasporto ed utilizzazione di aria compressa	Sì
Idonea per installazioni nei settori meccanico ed industriale	Sì
Misure Disponibili Acqua	10 - 28 (millimetri)
Misure Disponibili Gas	10 - 28 (millimetri)
Misure Disponibili Aria Compressa	10 - 28 (millimetri)
Limiti Impiego Acqua	D=10 - 28 mm, P=10 bar, T=0/+95 °C
Limiti Impiego Gas	D=10 - 28 mm, P=7 bar, T=0/+70 °C
Limiti Impiego Aria Compressa (O-Ring EPDM nero)	D=10 - 28 mm, P=10 bar, T=0/+95 °C
Limiti Impiego Aria Compressa (O-Ring HNBR giallo)	D=10 - 28 mm, P=10 bar, T=0/+70 °C

Raccordi a compressione in ottone - Tenuta metallica



Niples Doppia A
Compressione In Ottone
Tenuta Metallica D. 6
Nd6Org 3016

Codice	Riferimenti	Listino A	Listino B	Off.	Box
3016	D. 6	3,64 €	4,04 €	1	10
3018	D. 8	3,73 €	4,15 €	1	10
30110	D. 10	3,10 €	3,44 €	1	10
30112	D. 12	3,65 €	4,06 €	1	10
30114	D. 14	4,34 €	4,82 €	1	10
30116	D. 16	4,39 €	4,88 €	1	10
30118	D. 18	5,44 €	6,04 €	1	10
30122	D. 22	6,63 €	7,35 €	1	10
30128	D. 28	10,02 €	11,12 €	1	10
30135	D. 35	18,04 €	20,02 €	1	10
30142	D. 42	21,68 €	24,06 €	1	10
30154	D. 54	35,10 €	38,97 €	1	10



Gomito Doppio 90° 18 40118

Codice	Riferimenti	Listino A	Listino B	Off.	Box
4018	D. 8	4,59 €	5,10 €	1	10
40110	D. 10	5,70 €	6,33 €	1	10
40112	D. 12	4,53 €	5,02 €	1	10
40114	D. 14	5,08 €	5,64 €	1	10
40116	D. 16	5,58 €	6,19 €	1	10
40118	D. 18	8,54 €	9,47 €	1	10
40122	D. 22	8,80 €	9,77 €	1	10
40128	D. 28	11,29 €	12,53 €	1	10
40135	D. 35	21,43 €	23,79 €	1	10
40142	D. 42	25,65 €	28,47 €	1	10
40154	D. 54	48,72 €	54,08 €	1	10



Niples Femmina
A Compressione In Ottone
Tenuta Metallica

Codice	Riferimenti	Listino A	Listino B	Off.	Box
303C10	3/8"X10	2,70 €	3,00 €	1	10
303D10	1/2"X10	2,97 €	3,29 €	1	10
303C12	3/8"X12	2,76 €	3,06 €	1	10
303D12	1/2"X12	2,94 €	3,26 €	1	10
303D14	1/2"X14	3,50 €	3,88 €	1	10
303D16	1/2"X16	3,81 €	4,23 €	1	10
303G16	3/4"X16	5,61 €	6,23 €	1	10
303D18	1/2"X18	6,59 €	7,31 €	1	10
303G18	3/4"X18	4,92 €	5,46 €	1	10
303D22	1/2"X22	6,47 €	7,18 €	1	10
303G22	3/4"X22	6,44 €	7,15 €	1	10
303H22	1"X22	7,20 €	7,99 €	1	10
303G28	3/4"X28	9,84 €	10,92 €	1	10
303H28	1"X28	9,11 €	10,11 €	1	10
303HB35	1 1/4"X35	20,40 €	22,65 €	1	10
303HD42	1 1/2"X42	22,41 €	24,87 €	1	10
303OL54	2"X54	28,24 €	31,34 €	1	10



Niples Maschio
A Compressione In Ottone
Tenuta Metallica

Codice	Riferimenti	Listino A	Listino B	Off.	Box
302A6	1/8"X6	5,74 €	6,37 €	1	10
302B6	1/4"X6	5,74 €	6,37 €	1	10
302B8	1/4"X8	3,01 €	3,34 €	1	10
302C8	3/8"X8	3,60 €	3,99 €	1	10
302D8	1/2"X8	4,62 €	5,13 €	1	10
302B10	1/4"X10	3,52 €	3,91 €	1	10
302C10	3/8"X10	2,77 €	3,07 €	1	10
302D10	1/2"X10	2,48 €	2,75 €	1	10
302C12	3/8"X12	2,24 €	2,49 €	1	10
302D12	1/2"X12	2,58 €	2,86 €	1	10
302TAD14	1/2"X14	3,32 €	3,68 €	1	10
302TAD16	1/2"X16	3,53 €	3,91 €	1	10
302TAG16	3/4"X16	3,32 €	3,68 €	1	10
302D18	1/2"X18	3,30 €	3,66 €	1	10
302G18	3/4"X18	4,34 €	4,81 €	1	10
302D22	1/2"X22	5,10 €	5,66 €	1	10
302G22	3/4"X22	5,09 €	5,65 €	1	10
302H22	1"X22	5,92 €	6,57 €	1	10
302G28	3/4"X28	10,29 €	11,43 €	1	10
302H28	1"X28	8,02 €	8,90 €	1	10
302HB28	1 1/4"X28	14,12 €	15,67 €	1	10
302HB35	1 1/4"X35	15,39 €	17,09 €	1	10
302HD42	1 1/2"X42	19,49 €	21,64 €	1	10
302OL54	2"X54	31,88 €	35,39 €	1	10



Gomito Maschio
A Compressione In Ottone
Tenuta Metallica

Codice	Riferimenti	Listino A	Listino B	Off.	Box
402C12	3/8"X12	3,89 €	4,32 €	1	10
402D12	1/2"X12	3,42 €	3,79 €	1	10
402TAD14	1/2"X14	4,74 €	5,26 €	1	10
402TAD16	1/2"X16	4,96 €	5,51 €	1	10
402D18	1/2"X18	6,72 €	7,46 €	1	10
402G18	3/4"X18	6,36 €	7,06 €	1	10
402D22	1/2"X22	7,05 €	7,83 €	1	10
402G22	3/4"X22	7,74 €	8,59 €	1	10
402G28	3/4"X28	13,39 €	14,86 €	1	10
402H28	1"X28	13,48 €	14,96 €	1	10
402HB35	1 1/4"X35	21,77 €	24,16 €	1	10
402HD42	1 1/2"X42	26,60 €	29,52 €	1	10
402OL54	2"X54	36,16 €	40,14 €	1	10



Gomito Femmina Flangiato
A Compressione In Ottone
Tenuta Metallica

Codice	Riferimenti	Listino A	Listino B	Off.	Box
403WD12	1/2"X12	8,65 €	9,61 €	1	10
403WD14	1/2"X14	8,65 €	9,61 €	1	10
403WLD16	1/2"X16	15,24 €	16,92 €	1	10
403WLD18	1/2"X18	15,38 €	17,07 €	1	10
403WLD22	1/2"X22	11,37 €	12,62 €	1	10
403WLG22	3/4"X22	13,00 €	14,43 €	1	10



Tee 2 Lati
Compressione Centrale
Femmina

Codice	Riferimenti	Listino A	Listino B	Off.	Box
617D12	1/2"X12	8,84 €	9,81 €	1	10
617D14	1/2"X14	9,75 €	10,82 €	1	10
617G16	3/4"X16	10,75 €	11,93 €	1	10
617D18	1/2"X18	12,87 €	14,28 €	1	10
617D22	1/2"X22	15,17 €	16,84 €	1	10
617G22	3/4"X22	13,39 €	14,86 €	1	10
617H28	1"X28	25,34 €	28,13 €	1	10



Ogiva In Ottone

Codice	Riferimenti	Listino A	Listino B	Off.	Box
65O6	D. 6	0,25 €	0,27 €	1	10
65O8	D. 8	0,35 €	0,39 €	1	10
65O10	D. 10	0,28 €	0,31 €	1	10
65O12	D. 12	0,36 €	0,40 €	1	10
65O14	D. 14	0,36 €	0,40 €	1	10
65O16	D. 16	0,31 €	0,34 €	1	10
65O18	D. 18	0,44 €	0,49 €	1	10
65O22	D. 22	0,41 €	0,45 €	1	10
65O28	D. 28	0,70 €	0,78 €	1	10
65O35	D. 35	1,06 €	1,17 €	1	10
65O42	D. 42	1,33 €	1,48 €	1	10
65O54	D. 54	2,73 €	3,03 €	1	10



Gomito Femmina
A Compressione In Ottone
Tenuta Metallica

Codice	Riferimenti	Listino A	Listino B	Off.	Box
403C10	3/8"X10	4,96 €	5,51 €	1	10
403D10	1/2"X10	4,45 €	4,94 €	1	10
403C12	3/8"X12	3,73 €	4,15 €	1	10
403D12	1/2"X12	4,45 €	4,94 €	1	10
403D14	1/2"X14	4,77 €	5,30 €	1	10
403D16	1/2"X16	5,01 €	5,56 €	1	10
403G16	3/4"X16	12,06 €	13,38 €	1	10
403D18	1/2"X18	6,77 €	7,51 €	1	10
403G18	3/4"X18	7,35 €	8,16 €	1	10
403D22	1/2"X22	6,69 €	7,42 €	1	10
403G22	3/4"X22	8,59 €	9,54 €	1	10
403H22	1"X22	11,29 €	12,54 €	1	10
403H28	1"X28	12,66 €	14,05 €	1	10
403HB35	1 1/4"X35	22,59 €	25,07 €	1	10
403HD42	1 1/2"X42	28,24 €	31,34 €	1	10
403OL54	2"X54	61,03 €	67,74 €	1	10



Tee 3 Lati
A Compressione In Ottone
Tenuta Metallica

Codice	Riferimenti	Listino A	Listino B	Off.	Box
601EQ6	D. 6	4,04 €	4,49 €	1	10
601EQ8	D. 8	3,64 €	4,04 €	1	10
601EQ10	D. 10	6,18 €	6,86 €	1	10
601EQ12	D. 12	6,38 €	7,08 €	1	10
601EQ14	D. 14	6,56 €	7,28 €	1	10
601EQ16	D. 16	8,06 €	8,95 €	1	10
601EQ18	D. 18	9,75 €	10,82 €	1	10
601EQ22	D. 22	10,93 €	12,13 €	1	10
601EQ28	D. 28	17,49 €	19,41 €	1	10
601EQ35	D. 35	32,52 €	36,09 €	1	10
601EQ42	D. 42	38,26 €	42,46 €	1	10
601EQ54	D. 54	69,23 €	76,84 €	1	10



Dado Di Serraggio

Codice	Riferimenti	Listino A	Listino B	Off.	Box
63DS6	D. 6	0,63 €	0,70 €	1	10
63DS8	D. 8	0,75 €	0,83 €	1	10
63DS10	D. 10	0,82 €	0,91 €	1	10
63DS12	D. 12	0,84 €	0,93 €	1	10
63DS14	D. 14	1,18 €	1,30 €	1	10
63DS16	D. 16	1,43 €	1,59 €	1	10
63DS18	D. 18	1,30 €	1,45 €	1	10
63DS22	D. 22	1,67 €	1,85 €	1	10
63DS28	D. 28	2,40 €	2,67 €	1	10
63DS35	D. 35	4,10 €	4,55 €	1	10
63DS42	D. 42	6,01 €	6,67 €	1	10
63DS54	D. 54	12,30 €	13,65 €	1	10

RACCORDERIA MULTISTRATO CON INSERTO SMONTABILE



Nipples Maschio
Multistrato a stringere
inserto estraibile

Codice	Riferimenti	Listino A	Listino B	Off.	Box
NM1\2X16MS	1\2x16x2	1,99 €	2,21 €	1	10
NM1\2X20MS	1\2x20x2	3,40 €	3,77 €	1	10
NM3\4X20MS	3\4x20x2	4,28 €	4,75 €	1	5
NM3\4X26MS	3\4x26x3	7,62 €	8,46 €	1	5
NM1X26MS	1"x26x3	8,09 €	8,98 €	1	5



Nipples Femmina
Multistrato a stringere
inserto estraibile

Codice	Riferimenti	Listino A	Listino B	Off.	Box
NF1\2X16MS	1\2x16x2	2,08 €	2,30 €	1	10
NF1\2X20MS	1\2x20x2	3,42 €	3,80 €	1	10
NF3\4X20MS	3\4x20x2	3,94 €	4,38 €	1	5
NF3\4X26MS	3\4x26x3	6,64 €	7,37 €	1	5
NF1X26MS	1"x26x3	6,83 €	7,58 €	1	5



Nipples Doppio
Multistrato a stringere
inserto estraibile

Codice	Riferimenti	Listino A	Listino B	Off.	Box
ND16MS	16x16x2	3,16 €	3,51 €	1	10
ND20MS	20x20x2	5,05 €	5,60 €	1	10
ND26MS	26x26x3	11,10 €	12,32 €	1	5



Nipples Femmina
Multistrato a stringere
inserto estraibile

Codice	Riferimenti	Listino A	Listino B	Off.	Box
GD16MS	16x16x2	3,72 €	4,13 €	1	10
GD20MS	20x20x2	5,82 €	6,46 €	1	10
GD26MS	26x26x3	12,08 €	13,41 €	1	5



Gomito Femmina
Multistrato a stringere
inserto estraibile

Codice	Riferimenti	Listino A	Listino B	Off.	Box
GF1\2X16MS	1\2x16x2	2,70 €	3,00 €	1	10
GF1\2X20MS	1\2x20x2	3,86 €	4,29 €	1	10
GF3\4X20MS	3\4x20x2	5,51 €	6,12 €	1	5
GF3\4X26MS	3\4x26x3	7,66 €	8,50 €	1	5
GF1X26MS	1"x26x3	8,34 €	9,26 €	1	5



Gomito Maschio
Multistrato a stringere
inserto estraibile

Codice	Riferimenti	Listino A	Listino B	Off.	Box
GM1\2X16MS	1\2x16x2	3,79 €	4,21 €	1	10
GM1\2X20MS	1\2x20x2	4,95 €	5,49 €	1	10
GM3\4X20MS	3\4x20x2	5,16 €	5,72 €	1	5
GM3\4X26MS	3\4x26x3	8,05 €	8,93 €	1	5



Gomito Flangiato
Multistrato a stringere
inserto estraibile

Codice	Riferimenti	Listino A	Listino B	Off.	Box
GFL1\2X16MS	1\2x16x2	3,79 €	4,21 €	1	10



Tees tre lati
Multistrato a stringere
inserto estraibile

Codice	Riferimenti	Listino A	Listino B	Off.	Box
T16MS	16x16x16x2	5,00 €	5,55 €	1	10
T20MS	20x20x20x2	7,85 €	8,71 €	1	10
T26MS	26x26x26x3	17,74 €	19,69 €	1	5



Inserto per Multistrato

Codice	Riferimenti	Listino A	Listino B	Off.	Box
GFL1\2X16MS	1\2x16x2	3,79 €	4,21 €	1	10



Tees centrale Femmina
Multistrato a stringere
inserto estraibile

Codice	Riferimenti	Listino A	Listino B	Off.	Box
TF1\2X16MS	16x1\2x16x2	5,79 €	6,43 €	1	10
TF1\2X20MS	20x1\2x20x2	5,69 €	6,32 €	1	10
TF3\4X20MS	20x3\4x20x2	8,17 €	9,07 €	1	5
TF3\4X26MS	26x3\4x26x3	12,07 €	13,40 €	1	5
TF1X32M	32x1"x32x3	15,90 €	17,65 €	1	5



Niples Maschio Mult.
1/2"X16X2,0 NM1\2X16M



Niplo F. Nich.
Mult.1/2"X16X2,0
NF1\2X16M

Codice	Riferimenti	Listino A	Listino B	Off.	Box
NM1\2X16M	1/2"x16	1,85 €	2,05 €	1	10
NM1\2X20M	1/2"x20	3,37 €	3,74 €	1	10
NM3\4X16M	3/4"x16	3,07 €	3,41 €	1	5
NM3\4X20M	3/4"x20	3,40 €	3,77 €	1	5

Codice	Riferimenti	Listino A	Listino B	Off.	Box
NF1\2X16M	1/2"x16	2,00 €	2,22 €	1	10
NF1\2X20M	1/2"x20	3,32 €	3,68 €	1	10
NF3\4X16M	3/4"x16	2,53 €	2,81 €	1	5
NF3\4X20M	3/4"x20	4,07 €	4,51 €	1	5



Niples Doppia 16 Multistrato
ND16M



Gomito Doppio 16
Multistrato GD16M

Codice	Riferimenti	Listino A	Listino B	Off.	Box
ND16M	16x16	2,98 €	3,31 €	1	10
ND20M	20x20	4,14 €	4,60 €	1	10
ND26M	26x26	6,07 €	6,74 €	1	5
ND32M	32x32	15,38 €	17,07 €	1	5

Codice	Riferimenti	Listino A	Listino B	Off.	Box
GD16M	16x16	3,34 €	3,71 €	1	10
GD20M	20x20	5,43 €	6,02 €	1	10
GD26M	26x26	8,25 €	9,16 €	1	5
GD32M	32x32	14,21 €	15,77 €	1	5



Gomito F. 1/2"X20
Multistrato GF1\2X20M



Gomito Maschio 1/2"X20
Mult. GM1\2X20M

Codice	Riferimenti	Listino A	Listino B	Off.	Box
GF1\2X16M	1/2"x16	2,47 €	2,74 €	1	10
GF1\2X20M	1/2"x20	4,12 €	4,57 €	1	10
GF3\4X16M	3/4"x16	3,51 €	3,90 €	1	5
GF3\4X20M	3/4"x20	4,69 €	5,21 €	1	5

Codice	Riferimenti	Listino A	Listino B	Off.	Box
GM1\2X16M	1/2"x16	2,51 €	2,79 €	1	10
GM1\2X20M	1/2"x20	4,03 €	4,48 €	1	10
GM3\4X16M	3/4"x16	2,61 €	2,90 €	1	5
GM3\4X20M	3/4"x20	4,62 €	5,13 €	1	5



Tee Tre Vie Multistrato 16X2
T16M



Inserti per Multistrato

Codice	Riferimenti	Listino A	Listino B	Off.	Box
T16M	16x16	4,95 €	5,49 €	1	10
T20M	20x20	7,27 €	8,07 €	1	10
T26M	26x26	11,87 €	13,18 €	1	5
T32M	32x32	15,51 €	17,22 €	1	5

Codice	Riferimenti	Listino A	Listino B	Off.	Box
I16M	16x1/2	1,42 €	1,57 €	1	25
KCM16	22-24x16x2	5,41 €	6,01 €	1	25
KCM20	22-24x20x2	6,78 €	7,53 €	1	25



Gomito Flangiato 1/2"X16
Mult GFL1\2X16M



Tee Femmina Multistrato
D. 16X1/2"X16X2,0
TF1\2X16M

Codice	Riferimenti	Listino A	Listino B	Off.	Box
GFL1\2X16M	1/2"x16	3,42 €	3,80 €	1	10
GFL1\2X20M	1/2"x20	5,32 €	5,91 €	1	10

Codice	Riferimenti	Listino A	Listino B	Off.	Box
TF1\2X16M	16x1/2x16	3,92 €	4,35 €	1	10
TF1\2X20M	20x1/2x20	6,21 €	6,89 €	1	10
TF3\4X20M	20x3/4x20	7,03 €	7,80 €	1	5
TF3\4X26M	26x3/4x26	10,94 €	12,14 €	1	5



Niplo Maschio 1/2"X16Press.
NM1\2X16MP

Codice	Riferimenti	Listino A	Listino B	Off.	Box
NM1\2X16MP	1/2"x16	2,51 €	2,79 €	1	10
NM1\2X20MP	1/2"x20	3,37 €	3,74 €	1	10
NM3\4X16MP	3/4"x16	2,85 €	3,16 €	1	5
NM3\4X20MP	3/4"x20	3,91 €	4,34 €	1	5



Niples F. 1/2"X16 M. Press.
NF1\2X16MP

Codice	Riferimenti	Listino A	Listino B	Off.	Box
NF1\2X16MP	1/2"x16	2,63 €	2,92 €	1	10
NF1\2X20MP	1/2"x20	2,58 €	2,86 €	1	10
NF3\4X16MP	3/4"x16	2,73 €	3,03 €	1	5
NF3\4X20MP	3/4"x20	3,30 €	3,66 €	1	5



Niplo Doppio 16 Press.
ND16MP

Codice	Riferimenti	Listino A	Listino B	Off.	Box
ND16MP	16x16	2,35 €	2,61 €	1	10
ND20MP	20x20	3,08 €	3,42 €	1	10
ND26MP	26x26	3,94 €	4,37 €	1	5
ND32MP	32x32	5,82 €	6,46 €	1	5



Gomito Doppio D. 16
M.Press. GD16MP

Codice	Riferimenti	Listino A	Listino B	Off.	Box
GD16MP	16x16	1,71 €	1,90 €	1	10
GD20MP	20x20	4,24 €	4,71 €	1	10
GD26MP	26x26	9,51 €	10,55 €	1	5
GD32MP	32x32	11,64 €	12,92 €	1	5



Gomito Multist.Pinz. 1/2"X16
GF1\2X16MP

Codice	Riferimenti	Listino A	Listino B	Off.	Box
GF1\2X16MP	1/2"x16	3,02 €	3,35 €	1	10
GF1\2X20MP	1/2"x20	3,35 €	3,72 €	1	10
GF3\4X16MP	3/4"x16	3,52 €	3,90 €	1	10
GF3\4X20MP	3/4"x20	4,41 €	4,89 €	1	10



Gomito M. 1/2"X16 M. Press.
GM1\2X16MP

Codice	Riferimenti	Listino A	Listino B	Off.	Box
GM1\2X16MP	1/2"x16	3,24 €	3,60 €	1	10
GM1\2X20MP	1/2"x20	3,29 €	3,65 €	1	10
GM3\4X16MP	3/4"x16	3,42 €	3,79 €	1	10
GM3\4X20MP	3/4"x20	5,29 €	5,87 €	1	10



Tee D. 16 Mul. Pinsare
T16MP

Codice	Riferimenti	Listino A	Listino B	Off.	Box
T16MP	16x16	4,26 €	4,72 €	1	10
T20MP	20x20	4,69 €	5,21 €	1	10
T26MP	26x26	8,23 €	9,14 €	1	10
T32MP	32x32	9,65 €	10,71 €	1	10



Niples F. 1/2"X16 Gir. Mp
NF1\2X16GMP

Codice	Riferimenti	Listino A	Listino B	Off.	Box
NF1\2X16GMP	1/2"x16	5,46 €	6,06 €	1	10
NF3\4X16GMP	1/2"x20	6,09 €	6,76 €	1	10



Gomito Flang.1/2"X16
Mul.Pre. GFL1\2X16MP

Codice	Riferimenti	Listino A	Listino B	Off.	Box
GFL1\2X16MP	1/2"x16	3,12 €	3,47 €	1	10
GFL1\2X20MP	1/2"x20	3,61 €	4,01 €	1	10



Tee F. 1/2"X16 Mul. Press.
TF1\2x16MP

Codice	Riferimenti	Listino A	Listino B	Off.	Box
TF1\2X16MP	16x1/2x16	4,74 €	5,26 €	1	10
TF1\2X20MP	20x1/2x20	6,13 €	6,81 €	1	10
TF3\4X20MP	20x3/4x20	6,12 €	6,79 €	1	10
TF3\4X26MP	26x3/4x26	7,99 €	8,87 €	1	10



Nipples Multistrato a pinzare
per Gas Maschio

Codice	Riferimenti	Listino A	Listino B	Off.	Box
NM1/2X16MPG	1/2"x16	3,06 €	3,40 €	1	10
NM1/2X20MPG	1/2"x20	3,67 €	4,07 €	1	10
NM3/4X16MPG	3/4"x16	Arrivo	Arrivo	1	10
NM3/4X20MPG	3/4"x20	4,13 €	4,59 €	1	10



Nipples Multistrato a pinzare
per Gas Femmina

Codice	Riferimenti	Listino A	Listino B	Off.	Box
NF1/2X16MPG	1/2"x16	2,54 €	2,82 €	1	10
NF1/2X20MPG	1/2"x20	3,21 €	3,56 €	1	10
NF3/4X16MPG	3/4"x16	Arrivo	Arrivo	1	10
NF3/4X20MPG	3/4"x20	3,21 €	3,56 €	1	10



Nipples Multistrato a pinzare
per Gas Doppio

Codice	Riferimenti	Listino A	Listino B	Off.	Box
ND16MPG	16x16	3,47 €	3,86 €	1	10
ND20MPG	20x20	4,85 €	5,39 €	1	10
ND26MPG	26x26	7,03 €	7,80 €	1	10
ND32MPG	32x32	Arrivo	Arrivo	1	10



Gomito Multistrato a pinzare
per Gas Doppio

Codice	Riferimenti	Listino A	Listino B	Off.	Box
GD16MPG	16x16	3,43 €	3,81 €	1	10
GD20MPG	20x20	5,51 €	6,12 €	1	10
GD26MPG	26x26	7,16 €	7,94 €	1	10
GD32MPG	32x32	Arrivo	Arrivo	1	10



Gomito Multistrato a pinzare
per Gas Femmina

Codice	Riferimenti	Listino A	Listino B	Off.	Box
GF1/2X16MPG	1/2"x16	4,09 €	4,54 €	1	10
GF1/2X20MPG	1/2"x20	3,85 €	4,27 €	1	10
GF3/4X16MPG	3/4"x16	Arrivo	Arrivo	1	10
GF3/4X20MPG	3/4"x20	4,23 €	4,69 €	1	10



Gomito Multistrato a pinzare
per Gas Maschio

Codice	Riferimenti	Listino A	Listino B	Off.	Box
GM1/2X16MPG	1/2"x16	3,09 €	3,43 €	1	10
GM1/2X20MPG	1/2"x20	4,02 €	4,46 €	1	10
GM3/4X16MPG	3/4"x16	Arrivo	Arrivo	1	10
GM3/4X20MPG	3/4"x20	4,44 €	4,93 €	1	10



Tee tre lati Multistrato a
pinzare per Gas

Codice	Riferimenti	Listino A	Listino B	Off.	Box
T16MPG	16x16	5,93 €	6,59 €	1	10
T20MPG	20x20	7,79 €	8,65 €	1	10
T26MPG	26x26	12,08 €	13,41 €	1	10



Nipples Multistrato a pinzare
per Gas con dado girevole

Codice	Riferimenti	Listino A	Listino B	Off.	Box
NF1/2X16GMPG	1/2"x16	7,35 €	8,16 €	1	10
NF3/4X16GMPG	1/2"x20	7,73 €	8,58 €	1	10



Gomito Flangiato Multistrato
a pinzare per Gas Femmina

Codice	Riferimenti	Listino A	Listino B	Off.	Box
GFL1/2X16MPG	1/2"x16	4,91 €	5,45 €	1	10
GFL1/2X20MPG	1/2"x20	5,31 €	5,90 €	1	10



Tee femmina centrale due
lati Multistrato a pinzare per
Gas

Codice	Riferimenti	Listino A	Listino B	Off.	Box
TF1/2X16MPG	16x1/2x16	5,11 €	5,67 €	1	10
TF1/2X20MPG	20x1/2x20	6,63 €	7,36 €	1	10
TF3/4X20MPG	20x3/4x20	7,51 €	8,34 €	1	10
TF3/4X26MPG	26x3/4x26	10,64 €	11,81 €	1	10



Tubiplast italy multilayer pipe è prodotto e certificato in conformità alla normativa **UNI EN ISO 21003**. Idoneo alla realizzazione di impianti sanitari per il trasporto di acqua calda e fredda, in pressione e temperatura, per impianti di riscaldamento e di condizionamento.

1. Strato esterno di Polietilene reticolato (PEX)
2. Strato adesivo
3. Strato di Alluminio saldato con tecnologia testa a testa
4. Strato adesivo
5. Strato interno di Polietilene reticolato (PEX)



Ø esterno	mm	16	20	26	32
Ø interno	mm	12	16	20	26
Spessore parete	mm	2	2	3	3
Spessore alluminio	mm	0,2	0,2	0,3	0,3
Spessore rivestimento	mm	6	6	9	9
Volume d'acqua	mm	0,113	0,200	0,314	0,531
Lunghezza rotolo tubo nudo	m	100	100	100	50
Lunghezza rotolo tubo rivestito	m	50	50	50	25
Peso al metro	kg/m	0,11	0,145	0,26	0,34
Rugosità interna		0,007 mm			
Conduttività termica		0,45 w/m°C			
Coefficiente di dilatazione termica		0,026 mm/m°C			
Temperatura di utilizzo continuo		95 °C			
Temperatura massima momentanea		110 °C			
Pressione massima di esercizio		10 bar			
Grado di reticolazione PEXB		> 65%			
Diffusione ossigeno		0,00 g/l · h			
Raggio di curvatura		fino a 5 volte il diametro			

APPLICAZIONI: Impianti di riscaldamento e distribuzione di acqua potabile calda e fredda

CONDIZIONI DI ESERCIZIO: Pressione di esercizio 10 bar, massima temperatura di lavoro 95°C

ISOLAMENTO IN POLIETILENE ESPANSO BASSA DENSITÀ: La guaina in polietilene espanso è a cellule chiuse, priva dei gas CFC e HCFC, in accordo al Regolamento Europeo CEE/UE2037/2000

COLORE ISOLAMENTO: Rosso Ø 16-20-26-32, Blu Ø 16-20

SPESSORE ISOLAMENTO: Definito in accordo alla legge 10/91 e relativo decreto applicativo DPR 412/93

REAZIONE AL FUOCO: Autoestinguente Classe 1, in accordo al DM 26/06/1984 modificato dal DM 03/09/2001

MARCATURA: Il tubo viene marcato progressivamente ogni



Trattamento acqua
Water treatment



HYDRO MAX



Gruppo Pressurizzazione Pressost. Digitali N. 2 Rb 150M PD2-RB150M



Gruppo Pressurizzazione Pressost. Digitali N. 2 Rb 200M PD2-RB200M



Elettropompe In Ghisa Periferica Hp. 0,5 PMF050



Codice	Pz	Listino A	Listino B
PD2-RB150M	1	2059,57 €	2286,13 €

Codice	Pz	Listino A	Listino B
PD2-RB200M	1	2365,80 €	2626,03 €

Codice	Pz	Listino A	Listino B
PMF050	1	83,96 €	93,19 €
PMF050x5	5	78,08 €	86,67 €

Elettropompe Autodescante Ghisa Monogirante Hp. 0,8 GPIJTG0800AR



Elettropompe Autodescante Ghisa Monogirante Hp. 1 GPIJTG1000AR



Elettropompe Autodescante Inox Monogirante Hp. 1 GPVJTX0810



Codice	Pz	Listino A	Listino B
GPIJTG0800AR	1	195,51 €	217,02 €
GPIJTG0800ARx5	5	181,83 €	201,83 €

Codice	Pz	Listino A	Listino B
GPIJTG1000AR	1	195,51 €	217,02 €
GPIJTG1000ARx5	5	181,83 €	201,83 €

Codice	Pz	Listino A	Listino B
GPVJTX0810	1	164,82 €	182,95 €

Elettropompa centrifughe multicellulari in ghisa hp 0,6 GPVRGM0600



Elettropompa Autodescante In Ghisa Hp. 075 MDM0750



Elettropompa Autodescante In Ghisa Hp. 1 MDM1000



Codice	Pz	Listino A	Listino B
GPVRGM0600	0,60	164,75 €	182,87 €
GPVRGM0750	0,75	178,92 €	198,60 €
GPVRGM1000	1,00	220,75 €	245,03 €

Codice	Pz	Listino A	Listino B
MDM0750	1	327,65 €	363,69 €
MDM0750x2	2	313,71 €	348,22 €

Codice	Pz	Listino A	Listino B
MDM1000	1	339,79 €	377,16 €
MDM1000x2	2	325,33 €	361,11 €

Elettropompa Multicellulare Autodescante Sistema Venturi Hp. 0,6 GPIRMA0600AR



Elettropompa Multicellulare Autodescante Sistema Venturi Hp. 0,9



Elettropompa Multicellulare Autodescante Sistema Venturi Hp. 1,2 GPIRMA1200AR



Codice	Pz	Listino A	Listino B
GPIRMA0600AR	1	209,32 €	232,34 €
GPIRMA0600ARx2	2	194,66 €	216,08 €

Codice	Pz	Listino A	Listino B
GPIRMA0900/AR	1	234,62 €	260,43 €
GPIRMA0900/ARx2	2	218,19 €	242,20 €

Codice	Pz	Listino A	Listino B
GPIRMA1200AR	1	265,67 €	294,89 €
GPIRMA1200ARx2	2	247,07 €	274,25 €

REX 120-E MONO 1,2KW 230V 50HZ 15MT H07RNF RHP1202/E



si consiglia il montaggio di una sfera in uscita i litri secondo il vostro impianto



REX 120 AUT MONO 1,2KW 230V 50HZ 15MT H07RNF RHP1202



si consiglia il montaggio di una sfera in uscita i litri secondo il vostro impianto



Elettropompa Multicellulare Autodescante Sistema Venturi Hp. 1,6



Codice	Pz	Listino A	Listino B
RHP1202/E		302,38 €	335,65 €

Codice	Pz	Listino A	Listino B
RHP1202		247,86 €	275,12 €

Codice	Pz	Listino A	Listino B
GPIRMA1600AR	1	319,72 €	354,89 €
GPIRMA1600ARx2	2	303,74 €	337,15 €



Elettropompe Centrifughe Bigiranti



Codice	Riferimenti	Listino A	Listino B	Off.	Box
RBT1500	Hp. 1,5	351,95 €	390,67 €	1	1
RBT2000	Hp. 2,0	386,65 €	429,19 €	1	1
RBT3000	Hp. 3,0	685,32 €	760,70 €	1	1
RBT4000	Hp. 4,0	773,31 €	858,37 €	1	1



Pompe Sommerse Per P O Z Z I Da 4 " Hp. 1,00

Codice	Riferimenti	Listino A	Listino B	Off.	Box
ST-13-21T	HP 2 Trifase	438,70 €	486,96 €	1	1
ST-13-16T	HP 1,5 Trifase	379,22 €	420,93 €	1	1
ST-13-11M	HP 1,0 Mono	374,26 €	415,43 €	1	1

Elettropompa "PAL" è sistema automatico:



Elettropompa periferica autoadescante. Completa: vaso di espansione, pressostato, sensore di flusso, valvola di non ritorno, filtro. si avvia e si arresta automaticamente al momento dell'apertura e chiusura del rubinetto.
 PROTEZIONE MARCIA A SECCO È dotata di un controllo di flusso che arresta automaticamente la pompa in mancanza di acqua dopo 6 minuti. Successivamente farà 4 tentativi ad intervalli di 1-5-12-24 ore, avviandosi automaticamente per 2 minuti >
 PROTEZIONE ANTIGRIPPAGGIO In caso di mancato utilizzo si avvia automaticamente ogni 72 ore per un tempo di 8



Codice	Riferimenti	Listino A	Listino B	Off.	Box
PAL0800	Hp. 0,8	183,41 €	203,59 €	1	1
PAL1000	Hp. 1	195,81 €	217,34 €	1	1
PAL1500	Hp. 1,5	381,70 €	423,68 €	1	1

MONDIALJET 4"



Elettropompe Sommergibili Monoblocco Multistadio Verticali, Per Pozzi 4" Hp 1.5 230 Hz 50 Mt. 20H 05Vvf-Aut+C.B.

RED.MON1500/CB	1" 1/4	1,5	230	50 l/min	90 mt.
RED.MON1600/CB	1" 1/4	1,5	230	90 l/min	70 mt.

Codice	Riferimenti	Listino A	Listino B	Off.	Box
MJET150M	Hp. 1,5	433,75 €	481,46 €	1	1
MJET160M	Hp. 1,5	438,70 €	486,96 €	1	1



Elettropompe Sommergibili Monoblocco Multistadio Verticali, Per Pozzi 4" cvo 10 mt Red Roxy con Elettronica

Codice RXYAUTO

Si consiglia il montaggio di un vaso espansione per il funzionamento corretto della pompa

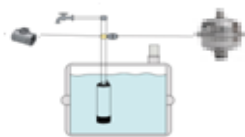

Codice	Riferimenti	Listino A	Listino B	Off.	Box
RXY0800E	Hp. 0,8	476,56 €	528,98 €	1	1
RXY1000E	Hp. 1,0	514,86 €	571,50 €	1	1
RXY1200E	Hp. 1,2	562,18 €	624,02 €	1	1
RXYAUTO	V. 0,16 lt	44,28 €	49,15 €	1	1



Elettropompe Sommergibili Monoblocco Multistadio Verticali, Per Pozzi 4"



Codice	Riferimenti	Listino A	Listino B	Off.	Box
RXY0800	Hp. 0,8	340,80 €	378,29 €	1	1
RXY1000	Hp. 1,0	394,09 €	437,44 €	1	1
RXY1200	Hp. 1,2	431,27 €	478,71 €	1	1
RXY1600	Hp. 1,8	495,71 €	550,24 €	1	1



Turbo J Man Mono 230V 50Hz Con Control Box



Maxima-S 100 Aut Mono 1Hp 230V 50Hz 6Mt H0 7Rnf



Elettropompa 1Hp 230V 50Hz Q max 225 l/min H max 8mt



Codice	Hp	Listino A	Listino B	Codice	Hp	Listino A	Listino B	Codice	Hp	Listino A	Listino B
GPVTBJ1003CB	1	348,12 €	386,42 €	VXS1000	1	203,89 €	226,31 €	VXX0752	1	143,76 €	159,57 €
TBJ1803CB	1,8	441,63 €	490,21 €								



Cutter 200 Man Tri 2Hp 380V 50Hz 10Mt H0 7Rn



Tiger-R 80 Con Galleggiante 0,8Hp 230V 50Hz 5Mt H07Rn



Tiger 200F Dn50 Con Galleggiante Tri 2Hp 380V 50Hz 10 M H07Rnf



Codice	Hp	Listino A	Listino B	Codice	Hp	Listino A	Listino B	Codice	Hp	Listino A	Listino B
TRC2005		1417,83 €	1573,79 €	TGR0800	0,8	279,41 €	310,14 €	TGR2005F	2	852,70 €	946,49 €
TRC3005		1563,27 €	1735,23 €	TGR0900		310,96 €	345,16 €	TGR3005F	3	1365,19 €	1515,36 €



Pompa Calpeda Ngxm



Codice	Riferimenti	Listino A	Listino B	Off.	Box
NGXM2	HP. 0,60	215,68 €	239,41 €	1	1
NGXM3	HP. 0,75	241,75 €	268,34 €	1	1
NGXM4	HP. 1,00	231,22 €	256,66 €	1	1



Elettropompa centrifughe Serie NMD Calpeda



Codice	Riferimenti	Listino A	Listino B	Off.	Box
NMDM20110A	HP. 1,00	348,41 €	386,73 €	1	1
NMDM20140B	HP. 1,50	540,39 €	599,83 €	1	1
NMDM20140AE	HP. 2,00	637,02 €	707,09 €	1	1
NMD25190CB	HP. 3,00	1029,72 €	1142,99 €	1	1
NMD25190BA	HP. 4,00	1144,14 €	1269,99 €	1	1
NMD25190AB	HP. 5,5	1398,96 €	1552,85 €	1	1



Pompa Calpeda Ctm 61



Codice	Riferimenti	Listino A	Listino B	Off.	Box
CTM61		141,27 €	156,81 €	1	1



Elettropompe Multistadio funzionamento silenzioso



Codice	Riferimenti	Listino A	Listino B	Off.	Box
MGPM203	HP. 0,60	229,31 €	254,53 €	1	1
MGPM204	HP. 0,75	260,81 €	289,50 €	1	1
MGPM205	HP. 1,00	304,54 €	338,04 €	1	1



Sistema di pressurizzazione autoadescante a velocità variabile.

MÈTA è una soluzione plug and play, la pompa è dotata di sensore di pressione, valvola di non ritorno e un serbatoio a membrana integrati. L'elettronica comanda in modo automatico l'avviamento lo spegnimento e consente di mantenere la pressione costante.

Codice	Riferimenti	Listino A	Listino B	Off.	Box
META		912,49 €	1012,87 €	1	1

Sistema di pressurizzazione autoadescante a velocità variabile.

MÈTA è una soluzione plug and play, la pompa è dotata di sensore di pressione, valvola di non ritorno e un serbatoio a membrana integrati. L'elettronica comanda in modo automatico l'avviamento lo spegnimento e consente di mantenere la pressione costante.



Codice	Riferimenti	Listino A	Listino B	Off.	Box
METASMALL		770,29 €	855,02 €	1	1



Elettropompa autodescante Serie NGL Calpeda



Codice	Riferimenti	Listino A	Listino B	Off.	Box
NGLM2	HP. 0,75	199,07 €	220,96 €	1	1
NGLM3	HP. 0,90	214,61 €	238,22 €	1	1
NGLM4	HP. 1,00	230,18 €	255,50 €	1	1



Elettropompa Serie CAM Autodescante Calpeda



Codice	Riferimenti	Listino A	Listino B	Off.	Box
CAM80E	Hp. 0,6	258,14 €	286,53 €	1	1
CAM90A	Hp. 0,75	327,08 €	363,05 €	1	1
CAM91A	Hp. 1,00	336,56 €	373,58 €	1	1



Elettropompa autodescante corpo inox Serie MXPM



Codice	Riferimenti	Listino A	Listino B	Off.	Box
MXPM203	HP. 0,60	237,38 €	263,49 €	1	1
MXPM204	HP. 0,75	267,60 €	297,04 €	1	1
MXPM205	HP. 1,00	335,52 €	372,43 €	1	1
MXPM404	HP. 1,00	348,04 €	386,33 €	1	1
MXPM405	HP. 1,5	416,66 €	462,49 €	1	1



Pompa Sommergibile In Acciaio Inox



Codice	Riferimenti	Listino A	Listino B	Off.	Box
GXRM9	Hp. 0,33	300,06 €	333,07 €	1	1
GXRM11	Hp. 0,5	324,46 €	360,15 €	1	1
GXRM13	Hp. 0,6	388,17 €	430,86 €	1	1



Elettropompa Calpeda Sommergibile GQSM 40-9 V.230/50



Codice	Riferimenti	Listino A	Listino B	Off.	Box
GQSM230		399,58 €	443,54 €	1	1

Pompe centrifughe multistadio sommergibili con camicia in acciaio inossidabile, bocca di mandata verticale e valvola di non ritorno in aspirazione. Capacità di aspirare acqua fino a 1 millimetro dal Suolo



Codice	Riferimenti	Listino A	Listino B	Off.	Box
GXMZERO		278,09 €	308,68 €	1	1



Elettropompa Autoadescante



Codice	Riferimenti	Listino A	Listino B	Off.	Box
SP5	Hp. 0,75	341,58 €	379,15 €	1	1
SP7	Hp. 1	398,50 €	442,34 €	1	1



Elettropompe Periferica 0,3 Kw 0,4 Hp



Codice	Riferimenti	Listino A	Listino B	Off.	Box
PM16	Hp. 0,4	76,79 €	85,24 €	1	1



Elettropompe Multistadio E Multigrante 0,5 Kw 0,75 Hp



Codice	Riferimenti	Listino A	Listino B	Off.	Box
3HM03P05M	Hp. 0,5	261,41 €	290,16 €	1	1
3HM04P05M	Hp. 0,75	253,86 €	281,78 €	1	1
3HM05P07M	Hp. 1	345,06 €	383,02 €	1	1



Elettropompa Drenaggio Acque Sporche E Chiare



Codice	Riferimenti	Listino A	Listino B	Off.	Box
DOC3	Hp. 0,33	194,84 €	216,27 €	1	1
DOC7	Hp. 0,75	254,00 €	281,94 €	1	1



Elettropompa Sommersa 5" Con Galleggiante 0,55



Codice	Riferimenti	Listino A	Listino B	Off.	Box
DOMO7VX	Hp. 0,33	308,23 €	342,13 €	1	1
DOMO10VX	Hp. 0,75	382,97 €	425,10 €	1	1



SOLO ATTACCHI SANITARI NO WC

Codice	Riferimenti	Listino A	Listino B	Off.	Box
GEOCLEAN		782,84 €	868,95 €	1	1



Elettropompe Centrifughe Con Bocche Filetate In Acciaio Inox



Codice	Riferimenti	Listino A	Listino B	Off.	Box
CAM70/45	Hp. 1,2	478,33 €	530,95 €	1	1
CAM70/33	Hp. 1	576,88 €	640,34 €	1	1



Elettropompa Sommersa 5" Con Galleggiante 0,55



Codice	Riferimenti	Listino A	Listino B	Off.	Box
3SC4/05/5CG	Hp. 1	535,37 €	594,26 €	1	1



Kit 3 Elettropompe Centrifuga Autoadescante gruppo Xilem 2 goulds+1 lowara = stessa pompa



Codice	Riferimenti	Listino A	Listino B	Off.	Box
KBGM5	Kit 3 pz 0,75	587,91 €	652,58 €	3	3
KBGM7	Kit 3 pz 1,00	622,77 €	691,28 €	3	3



Elettropompe Centrifuga Autoadescante



Codice	Riferimenti	Listino A	Listino B	Off.	Box
BGM5	Hp. 0,75	290,97 €	322,98 €	1	1
BGM7	Hp. 1,00	303,62 €	337,02 €	1	1

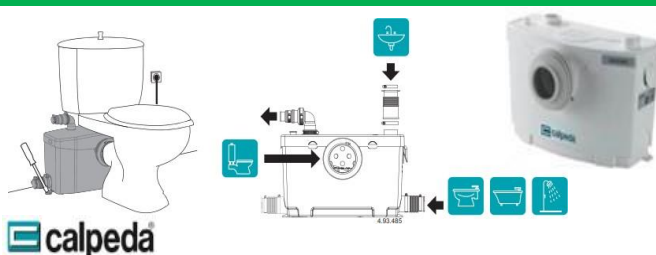

Codice	Riferimenti	Listino A	Listino B	Off.	Box
GEOCOMP		815,38 €	905,07 €	1	1

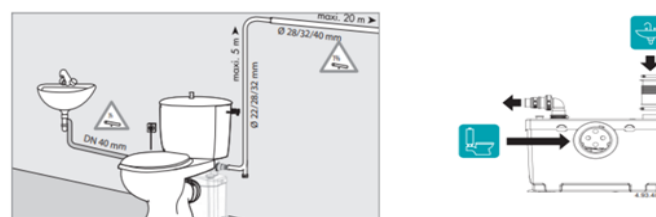

Codice	Riferimenti	Listino A	Listino B	Off.	Box
GEOTRIT		741,68 €	823,26 €	1	1

VASO+ATTACCO LAVABO

Sfera Staffa & Base Da 24 Lt



Codice	Riferimenti	Listino A	Listino B	Off.	Box
SS24C		67,61 €	75,05 €	1	25
SS24C5	Offertax5	63,26 €	70,22 €	5	25



I serbatoi sanitari polifunzionali a di espansione per impianti di H2O membrana fissa hanno il pregio di poter essere impiegati sia come vasi calda sanitaria o per impianti di riscaldamento, idonei ad assorbire le variazioni di volume causate dall'aumento di temperatura, sia come autoclavi negli impianti sanitari per acqua fredda. Questo duplice impiego è reso



Codice	Cap. litri	Diam. mm	H mm	DN1 mm	N	DN1	Listino A	Listino B
A2C2L11	5	205	225	3/4"			43,01 €	47,74 €
A2C2L16	8	205	300	3/4"			34,94 €	38,79 €
A2C2L19	11	270	300	3/4"			43,54 €	48,33 €
A2C2L24	18	270	410	3/4"			49,47 €	54,91 €
A2C2L27	24	320	355	1"			56,98 €	63,25 €
A2C2L31	35	400	390	1"			89,25 €	99,07 €
A2C2L34	50	400	585	1"			123,68 €	137,28 €
A2C2L37	80	400	820	1"			189,26 €	210,08 €
A2C2L38	100	500	775	1 1/4"			268,83 €	298,40 €

Polmone Autoclave Collaudato 8 bar



Codice	Riferimenti	Listino A	Listino B	Off.	Box
PO100	106 40	Lt. 100	331,41 €	367,87 €	
PO200	138 45	Lt. 200	432,57 €	480,15 €	
PO300	149 55	Lt. 300	480,95 €	533,85 €	
PO500	175 65	Lt. 500	676,33 €	750,73 €	
PO750	200 75	Lt. 750	963,87 €	1069,90 €	
PO1000	205 85	Lt. 1000	1302,05 €	1445,27 €	

COLLETTORE INOX ACCOPPIAMENTO POMPE



Codice	Riferimenti	Listino A	Listino B	Off.	Box
110155	D. 1"-L200	56,93 €	63,19 €	1	10
110156	D. 1 1/4"-L220	65,79 €	73,02 €	1	10
110157	D. 1 1/2"-L240	79,70 €	88,47 €	1	10
110158	D. 2"-L260	99,94 €	110,94 €	1	10

Sfera Hydrosat Norme Ce Lt.24



Codice	Riferimenti	Listino A	Listino B	Off.	Box
S24C		32,22 €	35,77 €	1	24
S24C24	Offertax24	30,61 €	33,98 €	24	24

Sfera per autoclave a membrana



Codice	Riferimenti	Listino A	Listino B	Off.	Box
S2C	2 LT	33,98 €	37,72 €	1	50
S5C	5 LT	36,46 €	40,47 €	1	40
S8C	8 LT	41,39 €	45,95 €	1	30
S12C	12 LT	47,31 €	52,52 €	1	24
S18C	18 LT	53,13 €	58,98 €	1	24

Polmone Autoclave N/collaudato



Codice	Riferimenti	Listino A	Listino B	Off.	Box
PZ100B	78 50	Lt. 50	269,09 €	298,69 €	

Polmone Autoclave N/collaudato



Codice	Riferimenti	Listino A	Listino B	Off.	Box
PZ50	88 40	Lt. 50	233,54 €	259,23 €	
PZ100	106 40	Lt. 100	269,09 €	298,69 €	
PZ200	138 45	Lt. 200	348,56 €	386,91 €	
PZ300	149 55	Lt. 300	418,28 €	464,29 €	
PZ500	175 65	Lt. 500	1301,30 €	1444,45 €	
PZ750	200 75	Lt. 750	1626,55 €	1805,47 €	
PZ1000	205 85	Lt. 1000	1905,39 €	2114,98 €	

Membrana Epdm Lt. 25 B/Larga Zz Per Sfere Zilmet - Varem Zz



Codice	Riferimenti	Listino A	Listino B	Off.	Box
MIA25LE	Membrana 24	4,05 €	4,49 €	1	25



Presscontrol Riparte 2,2 Bar

PROMO

Codice	Riferimenti	Listino A	Listino B	Conf.	Box
PSD02		31,63 €	35,11 €	1	6
PSD02x6	Offertax6	30,68 €	34,05 €	6	6
PSD02x12	Offertax12	30,05 €	33,35 €	12	6
PSD02x24	Offertax24	29,41 €	32,65 €	24	6

PRESS CONTROL



Codice	Riferimenti	Listino A	Listino B	Conf.	Box
PRESHYD	da 0,5<->3 hp	40,38 €	44,82 €	1	6

PRESS CONTROL



Codice	Riferimenti	Listino A	Listino B	Conf.	Box
GENYO8A/F22	Lowara	76,39 €	84,79 €	1	6



Galleg.Mercury Blu 10A Per Fossa Imhoff MTMENBMC10

Codice	Riferimenti	Listino A	Listino B	Conf.	Box
MTMENBMC10	10 mt	93,62 €	103,91 €	1	6



Gallegiante Elettrico Immersione 3Mt

Codice	Riferimenti	Listino A	Listino B	Conf.	Box
GEI03	mt. 03	14,68 €	16,29 €	1	12
GEI05	mt. 05	18,72 €	20,78 €	1	12
GEI07	mt. 07	23,28 €	25,84 €	1	12



Gallegiante Elettrico Esterno RIO

Codice	Riferimenti	Listino A	Listino B	Conf.	Box
RIO		24,59 €	27,30 €	1	10



Presscontrol Riparte 1,5 Bar

PROMO

Codice	Riferimenti	Listino A	Listino B	Conf.	Box
PSD01		31,63 €	35,11 €	1	6
PSD01x6	Offertax6	30,68 €	34,05 €	6	6
PSD01x12	Offertax12	30,05 €	33,35 €	12	6
PSD01x24	Offertax24	29,41 €	32,65 €	24	6



Pressostato Elettronico regolazione digitale funzionamento 1 pompa o modello per 2 pompe



Guarda Video
← Swtch1
Swth2 →



Codice	Riferimenti	Listino A	Listino B	Conf.	Box
0789SWITCH100	1 Pompa	66,92 €	74,28 €	1	6
0789SWITCH200	2 Pompe	89,23 €	99,04 €	1	6



Sistema di Pressione con Regolazione del minimo Max pressione 10 Bar

Codice	Riferimenti	Listino A	Listino B	Conf.	Box
KIT05	KIT05	85,57 €	94,98 €	1	6



Kit Di Pressione Espa Flussostato Regolabile Max 10 Bar 416 Std KIT01

Codice	Riferimenti	Listino A	Listino B	Conf.	Box
KIT01	Espa	48,46 €	53,79 €	1	6

Presscontrol Regolabile da 0,5<->3 bar



Codice	Riferimenti	Listino A	Listino B	Conf.	Box
PSD	Offerta 1 Pz	36,25 €	40,24 €	1	10
PSDx12	Offerta 12 Pz	34,16 €	37,92 €	12	10
PSDx24	Offerta 24 Pz	31,37 €	34,82 €	24	12



MABR010 Manometro 1/4" Attacco Dietro posteriore MABR010



MAB010 Manometro Attacco Lat. 10 B 1/4" MAB010

Codice	Riferimenti	Listino A	Listino B	Conf.	Box
MABR010	Lat.. D. 1/4"	5,11 €	5,67 €	1	12
MAB010	RaD. D.1/4"	4,55 €	5,06 €	1	12



Pressostato Da 1,4
4,6 Bar PC2



Pressostato Per
Elettropompe
Calpeda Pmat 5m-
10 PMAT5M



Pressostati Square
D 1,4-4,6 FSG-2

PROMO

Codice	Off.	Listino A	Listino B	Codice	Off.	Listino A	Listino B	Codice	Off.	Listino A	Listino B
PC2	1	6,96 €	7,72 €	PMAT5M	1	12,39 €	13,75 €	FSG-2	1	19,74 €	21,91 €
PC210	10	6,61 €	7,34 €	PMAT5M10	10	11,77 €	13,06 €	FSG-2x25	25	18,75 €	20,81 €



Centralina Prelievo
Acqua per pompe
autodescanti
riarmo automatico



Pressostato Square
D 5,6-10,5 FYG-32



Pressostato Square
D 2,8-7,0 FYG-22

Codice	Off.	Listino A	Listino B	Codice	Off.	Listino A	Listino B	Codice	Off.	Listino A	Listino B
CCAA	1	111,64 €	123,93 €	FYG-32	1	24,29 €	26,96 €	FYG-22	1	41,37 €	45,92 €
CCAAS	1	206,30 €	228,99 €	FYG-32x5	5	22,31 €	24,76 €	FYG-22x5	5	37,99 €	42,17 €



Indicatore 7 Livello
Inc. 503 ILL503



Indicatore Livello
X Liquidi 5 Funzioni
Senza Supporto
ILL008



Supporto Ind.
Livello III008 Zz
SPP009

Codice	Off.	Listino A	Listino B	Codice	Off.	Listino A	Listino B	Codice	Off.	Listino A	Listino B
ILL503	1	47,29 €	52,49 €	ILL008	1	44,66 €	49,57 €	SPP009	1	4,10 €	4,55 €
ILL503x5	5	42,13 €	46,76 €	SPP009	1	4,10 €	4,55 €				



Indicatore 4 Livello
Esterno ILL027



Sonda A Scalare In
Acciaio 5 Posizioni
+ Massa SAS009



Coppia Rubinetto
A Spillo 1/2" Per
Polmone Autoclave
CRP1\2

Codice	Off.	Listino A	Listino B	Codice	Off.	Listino A	Listino B	Codice	Off.	Listino A	Listino B
ILL027	1	31,95 €	35,46 €	SAS009	1	36,92 €	40,98 €	CRP1\2	1	39,07 €	43,36 €



Candeletta
Sondina 1/2"
Molpen CS1\2



Portamanometro
Da 1/2" PM1\2



Tubo Metacrilato
Da 16 Prezzo Di
Listino X 1 Metro
TM16

Codice	Off.	Listino A	Listino B	Codice	Off.	Listino A	Listino B	Codice	Off.	Listino A	Listino B
CS1\2	1	5,82 €	6,46 €	PM1\2	1	12,58 €	13,96 €	TM16	1 mt	7,55 €	8,38 €

Alimentatore Luise Aria per Polmone Autoclave



Codice	Riferimenti	Listino A	Listino B	Conf.	Box
MINI	100-500	46,83 €	51,98 €	1	10
MIDI	200-2000	95,82 €	106,36 €	1	6
MAXI	1000-4000	96,66 €	107,30 €	1	4
SMAXI	200-2000	98,37 €	109,19 €	1	2

Alimentatore Amis
Aria per Polmone Autoclave



Codice	Riferimenti	Listino A	Listino B	Conf.	Box
A750	24-750	32,49 €	36,06 €	1	10
A2000	1000-2000	38,56 €	42,80 €	1	4

Condensatore doppio Faston



Codice	Riferimenti	Listino A	Listino B	Conf.	Box
C8MF	8 mf	3,64 €	4,04 €	1	10
C10MF	10 mf	3,64 €	4,04 €	1	10
C12MF	12 mf	2,67 €	2,96 €	1	10
C12,5MF	12,5 mf	4,85 €	5,39 €	1	10
C16MF	16 mf	4,85 €	5,39 €	1	10
C20MF	20 mf	6,07 €	6,74 €	1	10
C25MF	25 mf	7,28 €	8,08 €	1	10
C30MF	30 mf	7,28 €	8,08 €	1	10
C35MF	35 mf	7,04 €	7,81 €	1	10
C40MF	40 mf	8,49 €	9,43 €	1	10
C50MF	50 mf	10,24 €	11,37 €	1	10

Valvola Di Ricambio In Ott. Per
Alimentatore D'Aria VRA



Codice	Riferimenti	Listino A	Listino B	Conf.	Box
VRA		4,81 €	5,34 €	1	10



In un sistema per autoclavi con elettropompe sommerse, una eventuale esuberanza d'aria sarà espulsa dalla valvola di sfiato che stabilizzerà il livello dell'acqua nel punto in cui è collegata.

Codice	Riferimenti	Listino A	Listino B	Conf.	Box
VSAG1	D.1"	25,14 €	27,91 €	1	10
VSAG11/4	D.11/4"	28,69 €	31,85 €	1	10



Valvola
Sicurezza sede
in gomma

Codice	Riferimenti	Listino A	Listino B	Conf.	Box
VSP1\2	D.1/2"	11,49 €	12,75 €	1	10
VSP3\4	D.3/4"	43,62 €	48,42 €	1	10
VSP1	D.1"	66,48 €	73,79 €	1	10
VSP11\4	D.11/4"	46,45 €	51,56 €	1	6
VSP11\2	D.11/2"	52,60 €	58,39 €	1	4
VSP2	D.2"	73,78 €	81,90 €	1	2



Flex Alimentatore MF

Codice	Riferimenti	Listino A	Listino B	Conf.	Box
FABD700	1/2" MF	6,83 €	7,58 €	1	12
FADG1000	1/2"MX3/4"F	15,94 €	17,69 €	1	12



Condensatore con cavo
Bipolare elettrico

Codice	Riferimenti	Listino A	Listino B	Conf.	Box
CDICB10	10 mf	3,80 €	4,21 €	1	10
CDICB12	12 mf	5,06 €	5,62 €	1	10
CDICB12,5	12,5 mf	4,40 €	4,89 €	1	10
CDICB16	16 mf	4,61 €	5,11 €	1	10
CDICB20	20 mf	6,33 €	7,02 €	1	10
CDICB25	25 mf	5,59 €	6,21 €	1	10
CDICB30	30 mf	7,59 €	8,43 €	1	10
CDICB40	40 mf	7,84 €	8,71 €	1	10
CDICB50	50 mf	10,68 €	11,85 €	1	10

Raccordo 5 Vie 1" Da 110 R1A110



Codice	Riferimenti	Listino A	Listino B	Conf.	Box
R1A110	D.1"	5,37 €	5,96 €	1	10

Raccordo 5 Vie 1" 90 M-M R1A90M



Codice	Riferimenti	Listino A	Listino B	Conf.	Box
R1A90M	D.1"	4,78 €	5,31 €	1	10

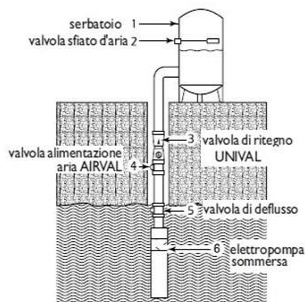

Valvola Presa Aria Automatica



Codice	Riferimenti	Listino A	Listino B	Conf.	Box
VPA1	D.1"	Arrivo	Arrivo	1	10
VPA11\4	D.11/4"	Arrivo	Arrivo	1	10
VPA11\2	D.11/2"	28,46 €	31,60 €	1	10
VPA2	D.2"	28,46 €	31,60 €	1	10



Valvola Tenuta Planet Da 1/2" VT1\2P

Codice	Riferimenti	Listino A	Listino B	Conf.	Box
VT1\2P	D.1/2"	3,93 €	4,37 €	1	10
VT3\4P	D.3/4"	5,18 €	5,75 €	1	10
VT1P	D.1"	8,08 €	8,97 €	1	10
VT11\4P	D.11/4"	11,13 €	12,36 €	1	10
VT11\2P	D.11/2"	16,87 €	18,72 €	1	10
VT2P	D.2"	23,62 €	26,22 €	1	10
VT21\2P	D.21/2"	Arrivo	Arrivo	1	10
VT3P	D.3"	Arrivo	Arrivo	1	10
VT4P	D.4"	Arrivo	Arrivo	1	10



Nipples Forato X Flex Alimentatore 1"X1/4" NF1X1\4

Codice	Riferimenti	Listino A	Listino B	Conf.	Box
NF1X1\4	1"x1/4"	3,34 €	3,71 €	1	10
NF11\4X1\2	1"1/4x1/2"	5,04 €	5,59 €	1	10
NF11\2X1\2	1"1/2x1/2"	6,71 €	7,44 €	1	10
NF2X1\2	2"x1/2"	8,93 €	9,91 €	1	10



Valvola A Sfera A Cappuccio Piombabile Ff D. 1/2" 180015



Codice	Riferimenti	Listino A	Listino B	Conf.	Box
180015	D. 1/2"	4,89 €	5,43 €	1	20
180020	D. 3/4"	6,87 €	7,63 €	1	20
180025	D. 1"	11,76 €	13,06 €	1	10
180032	D. 11/4"	16,19 €	17,97 €	1	4
180040	D. 11/2"	22,90 €	25,42 €	1	10
180050	D. 2"	37,98 €	42,16 €	1	4



Contatore Getto Multiplo Completo Coperchio & Raccordi Ideale per portate acque maggiori

Codice	Riferimenti	Listino A	Listino B	Conf.	Box
CAMD	D. 1/2"	33,22 €	36,88 €	1	10
CAMG	D. 3/4"	39,85 €	44,23 €	1	10
CAMH	D.1"	60,12 €	66,73 €	1	10
CAMHB	D.11/4"	83,63 €	92,83 €	1	10
CAMHD	D.11/2"	122,06 €	135,49 €	1	10
CAMOL	D.2"	192,10 €	213,23 €	1	10



Valvola A Sfera A Cappuccio Piombabile Mf D. 1/2" 181015



Codice	Riferimenti	Listino A	Listino B	Conf.	Box
181015	D. 1/2"	4,89 €	5,43 €	1	20
181020	D. 3/4"	6,87 €	7,63 €	1	20
181025	D. 1"	11,76 €	13,06 €	1	10
181032	D. 11/4"	16,19 €	17,97 €	1	6
181040	D. 11/2"	22,90 €	25,42 €	1	6
181050	D. 2"	37,98 €	42,16 €	1	4



Contatore Asciutto Getto Unico Completo Coperchio & Raccordi

Codice	Riferimenti	Listino A	Listino B	Conf.	Box
CAUD	D. 1/2"	27,07 €	30,05 €	1	20
CAUG	D. 3/4"	29,10 €	32,30 €	1	20
CAUH	D. 1"	38,61 €	42,86 €	1	10



Valvola ad Angolo Calotta libera "Avant Contatore"

Codice	Riferimenti	Listino A	Listino B	Conf.	Box
104201520	F. 1/2"xF.3/4"	12,81 €	14,22 €	1	20
104202020	F. 3/4"xF.3/4"	14,02 €	15,57 €	1	20

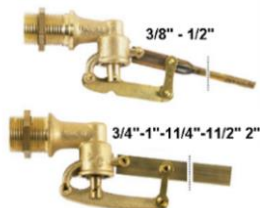
Galleggiante 5 Copp.Pes. D.
3/8" G5C3\8Gall. Alta Press. Molla 3/4"
GAP3\4M

Codice	Riferimenti	Listino A	Listino B	Conf.	Box
G5C3\8	D.3/8"	7,29 €	8,09 €	1	10
G5C1\2	D.1/2"	11,31 €	12,55 €	1	10
G5C3\4P	D.3/4"	13,66 €	15,17 €	1	10
G5C1	D.1"	14,93 €	16,57 €	1	10
G5C11\4	D.1.1/4"	31,02 €	34,43 €	1	10
G5C11\2	D.1.1/2"	61,74 €	68,53 €	1	10
G5C2	D.2"	35,68 €	39,61 €	1	10

Codice	Riferimenti	Listino A	Listino B	Conf.	Box
GAP3\4M	D.3/4"	18,04 €	20,02 €	1	10
GAP1M	D.1"	20,04 €	22,24 €	1	10
GAP11\4M	D.1.1/4"	47,46 €	52,68 €	1	10
GAP11\2M	D.1.1/2"	53,79 €	59,70 €	1	10
GAP2M	D.2"	72,46 €	80,43 €	1	10

Sfera Galleggiante Inglese 120
SGI120Galleggiante Inglese Tipo Sicilia
In Ottone D. 1/2" GI1\2N

Codice	Riferimenti	Listino A	Listino B	Conf.	Box
SGI120	D. 120	1,78 €	1,97 €	1	10
SGI150	D, 150	2,71 €	3,01 €	1	10

Codice	Riferimenti	Listino A	Listino B	Conf.	Box
GI1\2N	D.1/2"	8,35 €	9,27 €	1	10
GI3\4N	D.3/4"	8,86 €	9,83 €	1	10
GI1N	D.1"	9,43 €	10,46 €	1	10

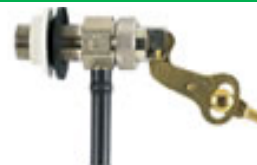
Galleggiante Silenzioso 3/4"
Sede Inox GSAB3\4Galleggiante Cassetta Catis
3/8" incluso sfera

Codice	Riferimenti	Listino A	Listino B	Conf.	Box
GSAB3\4	D.3/4"	15,76 €	17,49 €	1	10
GSAB1	D.1"	14,57 €	16,18 €	1	10

Codice	Riferimenti	Listino A	Listino B	Conf.	Box
GCC3\8	D.3/8"	11,59 €	12,86 €	1	10

Sfera Gall. Asta Pass. D. 120
SG120Sfera Combi Da 120 Barra +
In. SC120

Codice	Riferimenti	Listino A	Listino B	Conf.	Box
SG120	120 Asta	1,52 €	1,69 €	1	10
SG150	150 Asta	2,48 €	2,76 €	1	10
SG180	180 Asta	3,39 €	3,76 €	1	10
SG220	220 Asta	6,71 €	7,45 €	1	10

Codice	Riferimenti	Listino A	Listino B	Conf.	Box
SC120	120 combi	2,02 €	2,25 €	1	10
SC150	150 combi	3,29 €	3,65 €	1	10
SC180	180 combi	2,68 €	2,97 €	1	10
SC220	220 combi	5,42 €	6,02 €	1	10

Gall. Alta Press. Molla 3/4"
GAP3\4MSfera Galleggiante Da 90 Tonda
SG90T

Codice	Riferimenti	Listino A	Listino B	Conf.	Box
SG90T	90 Tonda	0,94 €	1,04 €	1	10

Codice	Riferimenti	Listino A	Listino B	Conf.	Box
GAP3\4M	D.3/4"	18,04 €	20,02 €	1	10
GAP1M	D.1"	20,04 €	22,24 €	1	10
GAP11\4M	D.1.1/4"	47,46 €	52,68 €	1	10
GAP11\2M	D.1.1/2"	53,79 €	59,70 €	1	10
GAP2M	D.2"	72,46 €	80,43 €	1	10

Sfera Galleggiante 90 Piatta
SG90P

Codice	Riferimenti	Listino A	Listino B	Conf.	Box
SG90P	90 Piatta	0,63 €	0,70 €	1	10



Galleggiante Cassetta Zaino
Rambo 3/8" GCZR

Codice	Riferimenti	Listino A	Listino B	Conf.	Box
GCZR		5,74 €	6,37 €	1	12



Kit Rubinetto Sq.1/2"X10
Bronzo KCRDC47

Codice	Riferimenti	Listino A	Listino B	Conf.	Box
KCRDC47		34,90 €	38,74 €	1	12



Rubinetto Squadra 1/2" F -
1/2" M C-Codulo 3/8" M
RSCWCD

Codice	Riferimenti	Listino A	Listino B	Conf.	Box
RSCWCD		7,09 €	7,87 €	1	12



Rubinetto Sq. 3/8" U.3/8" Reg.
RSCCR

Codice	Riferimenti	Listino A	Listino B	Conf.	Box
RSCCR		Arrivo	Arrivo	1	12



Riduttore Pressione 1/2" Pes. RB1\2P

Codice	Riferimenti	Listino A	Listino B	Conf.	Box
RB1\2P	D.1/2"	31,22 €	34,66 €	1	10
RB3\4P	D.3/4"	41,88 €	46,49 €	1	10
RB1P	D.1"	66,33 €	73,63 €	1	10
RB11\4P	D.1.1/4"	79,59 €	88,35 €	1	10
RB11\2P	D.1.1/2"	100,13 €	111,15 €	1	10
RB2P	D.2"	126,41 €	140,31 €	1	10



Riduttore Pressione 1/2" 3 Pz
RB1\2PB

Codice	Riferimenti	Listino A	Listino B	Conf.	Box
RB1\2PB	D.1/2"	40,19 €	44,61 €	1	10
RB3\4PB	D.3/4"	65,82 €	73,05 €	1	10
RB1PB	D.1"	72,95 €	80,98 €	1	10
RB11\4PB	D.1.1/4"	121,72 €	135,11 €	1	10
RB11\2PB	D.1.1/2"	134,85 €	149,69 €	1	10
RB2PB	D.2"	202,93 €	225,25 €	1	10



Riduttore Pressione Tipo
Mignon

Codice	Riferimenti	Listino A	Listino B	Conf.	Box
RB1\2M	D.1/2"	18,90 €	20,98 €	1	10
RB3\4M	D.3/4"	22,19 €	24,63 €	1	10



VASO SAN Ricambio vaso
trasparente per Contenitore serie
plastica 3 Pezzi

Codice	Riferimenti	Listino A	Listino B	Conf.	Box
V3H10	Vaso Ricambio	9,17 €	10,18 €	1	1
V3H07	Vaso Ricambio	Arrivo	Arrivo	1	1
V3H05	Vaso Ricambio	Arrivo	Arrivo	1	1



Riduttore di pressione bocchettone
maschio laterali, sui due lati per
manometro da 1/4" gas.
Funzionamento a pistone. Sede
acciaio inox 18/10. Pressione max a
monte 25 bar, pressione a valle
regolabile da 1 a 6 bar, pressione a
valle impostata 3 bar in fabbrica.

Codice	Riferimenti	Listino A	Listino B	Conf.	Box
RB1\2MM	D.1/2"	41,79 €	46,39 €	1	10
RB3\4MM	D.3/4"	68,44 €	75,97 €	1	10
RB1MM	D.1"	70,28 €	78,01 €	1	10
RB11\4M	D.1.1/4"	126,59 €	140,52 €	1	10



Contenitore 3 Pz vetro
trasparente per acqua

Codice	Riferimenti	Listino A	Listino B	Conf.	Box
C3G10	9"3/4 D. 3/4"	20,37 €	22,61 €	1	1
C3H10	9"3/4 D. 1"	23,28 €	25,84 €	1	1
C3G7	7" D. 3/4"	23,23 €	25,78 €	1	1
C3H7	7" D. 1"	20,06 €	22,27 €	1	1
C3D5	5" D. 1/2"	24,80 €	27,52 €	1	1
C3G5	5" D. 3/4"	19,10 €	21,20 €	1	1
C3H5	5" D. 1"	Arrivo	Arrivo	1	1



Contenitore 3 Pz 9/34" vetro
trasparente per acqua

Codice	Riferimenti	Listino A	Listino B	Conf.	Box
10148020	D. 3/4"	Arrivo	Arrivo	1	1
10148001	D. 1"	Arrivo	Arrivo	1	1



Contenitore Doppio 9"3/4 D.
3/4 cont. Duplex 10148012

Codice	Riferimenti	Listino A	Listino B	Conf.	Box
10148012	D. 3/4"	56,80 €	63,05 €	1	1
10148002	D. 1"	56,80 €	63,05 €	1	1



Cartuccia F/Avvolto 9/34"
20Mc Nastro Al Cotone
CFA1020

Codice	Riferimenti	Listino A	Listino B	Conf.	Box
CFA1020	9"3/4	3,64 €	4,04 €	1	1
CFA720	7"	2,97 €	3,30 €	1	1
CFA520	5"	1,77 €	1,97 €	1	1



Cartuccia Carb./Attivi
9/34"20 CCA1020

Codice	Riferimenti	Listino A	Listino B	Conf.	Box
CCA1020	9"3/4	13,41 €	14,89 €	1	1
CCA720	7"	8,81 €	9,78 €	1	1
CCA520	5"	7,05 €	7,83 €	1	1



Cartuccia R/Lavabile
9/34"250M CRL10250

Codice	Riferimenti	Listino A	Listino B	Conf.	Box
CRL10250	9"3/4	9,71 €	10,78 €	1	1
CRL7250	7"	7,96 €	8,83 €	1	1
CRL5250	5"	7,44 €	8,26 €	1	1



Cartuccia Sali Minerali

Codice	Riferimenti	Listino A	Listino B	Conf.	Box
CSM1020	9"3/4	25,75 €	28,58 €	1	1
CCM720	7"	Arrivo	Arrivo	1	1
CCM520	5"	Arrivo	Arrivo	1	1



Chiave Universale X
Contenitore CUF

Codice	Riferimenti	Listino A	Listino B	Conf.	Box
CUF		3,08 €	3,42 €	1	1

Codice	Riferimenti	Listino A	Listino B	Conf.	Box
		Arrivo	Arrivo	1	1



Staffa per contenitori filtro

Codice	Riferimenti	Listino A	Listino B	Conf.	Box
10145606	1 posto	4,14 €	4,59 €	1	1
	2 posti	Arrivo	Arrivo	1	1
	3 posti	Arrivo	Arrivo	1	1

Codice	Riferimenti	Listino A	Listino B	Conf.	Box
		Arrivo	Arrivo	1	1
		Arrivo	Arrivo	1	1
		Arrivo	Arrivo	1	1



Salvalavatrice Da 3/4" C/Sali
SLG

Codice	Riferimenti	Listino A	Listino B	Conf.	Box
SLG		7,59 €	8,43 €	1	1



Sale Addolcimento Acqua
Sacco 25kg SALE25

Codice	Riferimenti	Listino A	Listino B	Conf.	Box
SALE25	Addolcitori	9,91 €	11,00 €	1	1



Trattamento Acqua



Tipo: Compact Coffee

Tipo: Compact Slim

Addolcitore cabinato in due modelli dalle dimensioni compatte. con valvola automatica elettronica a rigenerazione volume/tempo con salamoia e bombola in materiale composito con liner, in PE rivestito in fibra di vetro e resina epossidica in un unico corpo. Completo di by-pass. Accessori: disinfezione automatica resine (coD. NCSAL05) installata direttamente sulla valvola, tubo di scarico in PVC e valvola di sicurezza pozzetto salamoia con galleggiante (coD.RF09959). VALVOLE RUNXIN

- Ampio display LCD retroilluminato
- Adotta testate ermetiche ceramica alto grado
- Sistema per controllo di flussi affidabile
- Indicazione di mancata alimentazione elettrica
- Blocco pulsanti in assenza di operazioni un minuto
- Miscelatore di durezza integrato

Compact E Slim ESL

- Alimentazione 230V 50 Hz
- Pres. min 2 bar - max 6 bar-5+50° C

Codice	Riferimenti	Listino A	Listino B	Conf.	Box
NCCVE12ENJRBP	12 ENJRBP	658,42 €	730,84 €	1	1
NCCVE12ESLRBP	12 ESLRBP	676,93 €	751,39 €	1	1
NCCVE18ESLRBP	18 ESLRBP	740,20 €	821,63 €	1	1
NCCVE28ESLRBP	28 ESLRBP	1088,44 €	1208,17 €	1	1
NCBTE70E268BP	70 E268BP	1889,93 €	2097,82 €	1	1

S.I.M.B.L. S.R.L.

PROFESSIONALITA' E QUALITA'



EVOKlima™

TECNOLOGIA - BENESSERE - RISPETTO PER L'AMBIENTE



Contenitori per liquidi alimentari

...con noi la natura è Protetta!

PROFESSIONALITA' E QUALITA'



EVOKlima™

TECNOLOGIA - BENESSERE - RISPETTO PER L'AMBIENTE

Modello
CV VERTICALE



Tipo CV
CILINDRICO VERTICALE



Articolo	Litri	Alt.	Lungh.	Largh.	Listino A	Listino B
CV90	90	80	-	43	83,07 €	92,21 €
CV125	125	95	-	43	97,13 €	107,81 €
CV250	250	95	-	62	121,41 €	134,77 €
CV340	340	128	-	62	148,25 €	164,56 €
CV500	500	136	-	73	191,70 €	212,79 €
CV1000	1.000	160	-	94	292,66 €	324,86 €
CV1500	1.500	180	-	110	457,53 €	507,85 €
CV2000	2.000	190	-	125	564,88 €	627,01 €
CV3000	3.000	220	-	144	791,08 €	878,10 €
CV5000	5.000	220	-	170	1085,03 €	1204,38 €
CVA750	750	185	-	75	235,15 €	261,02 €
CVA1000	1.000	220	-	76	292,66 €	324,86 €

Modello

Articolo	Litri	Alt.	Lungh.	Largh.	Listino A	Listino B
RB200	200	55	78	56	127,80 €	141,86 €
RB300	300	60	83	63	157,19 €	174,49 €
RB500	500	67	104	78	237,71 €	263,86 €
RM500	500	78	104	67	237,71 €	263,86 €
RA30	30	40	34	34	33,23 €	36,88 €
RA60	60	61	34	34	49,84 €	55,32 €
RA200	200	85	50	56	127,80 €	141,86 €
RA300	300	87	60	66	157,19 €	174,49 €
RA500	500	107	76	63	237,71 €	263,86 €

Tipo RM
RETTANGOLARE MEDIO

Tipo RA
RETTANGOLARE ALTO

Tipo RB
RETTANGOLARE BASSO

Articolo	Litri	Alt.	Lung.	Larg.	Listino
RB400	400	55	103	78	162,21

Articolo	Litri	Alt.	Lungh.	Largh.	Listino A	Listino B
OV100	100	64	58	40	102,24 €	113,49 €
OV200	200	75	70	48	127,80 €	141,86 €
OV300	300	87	86	60	157,19 €	174,49 €
OV500	500	95	95	65	246,65 €	273,79 €
OV750	750	100	120	70	306,72 €	340,46 €
OV1000	1.000	130	135	76	437,08 €	485,16 €

Modello
RETTANGOLARE



STRETTO MOD. OV

Modello



OR OROLOGIO

Articolo	Litri	Alt.	Lungh.	Largh.	Listino A	Listino B
OR500	500	125	120	45	227,48 €	252,51 €
OR1000	1.000	140	135	60	396,18 €	439,76 €

Modello
CO ORIZZONTALE



Tipo CO
CILINDRICO ORIZZONTALE

Articolo	Litri	Alt.	Lungh.	Largh.	Listino A	Listino B
CO300	300	68	106	63	164,86 €	183,00 €
CO600	600	82	124	75	226,21 €	251,09 €
CO800	800	87	144	80	272,21 €	302,16 €
CO1000	1.000	92	170	85	293,94 €	326,27 €
CO1500	1.500	117	156	110	488,20 €	541,90 €
CO2000	2.000	130	175	123	608,33 €	675,25 €
CO3000	3.000	155	190	148	945,72 €	1049,75 €
CO5000	5.000	180	230	172	1405,80 €	1560,44 €

Modello
ORIZZONTALE
COC



Articolo	Litri	Alt.	Lungh.	Largh.	Listino A	Listino B
COC600	600	90	116	86	226,21 €	251,09 €
COC1000	1.000	107	142	95	293,94 €	326,27 €

Modello
CCA & PISCINA



Tipo CCA
Cilindrico a cielo aperto

Articolo	Litri	Alt.	Lungh.	Largh.	Listino A	Listino B
CCA500	500	114	-	103	192,98 €	214,21 €
CCA1000	1.000	143	-	124	301,61 €	334,79 €
PISCINA	PISCINA	100	-	255	504,88 €	560,42 €



Articolo	Litri	Alt.	Lungh.	Largh.	Listino A	Listino B
PN200	200	49	-	76	97,13 €	107,81 €
PN300	300	63	-	80	121,41 €	134,77 €
PN500	500	82	-	97	154,64 €	171,65 €
PN1000	1.000	110	-	118	219,82 €	244,00 €
PN1500	1.500	138	-	124	370,62 €	411,39 €
PN2000	2.000	121	-	153	497,14 €	551,83 €
PN3000	3.000	140	-	200	664,56 €	737,66 €
PN5000	5.000	180	-	195	1022,40 €	1134,87 €
PN7500	7.500	170	-	245	1211,55 €	1344,82 €
PN8000	8.000	210	-	225	1405,80 €	1560,44 €
PN10000	10.000	233	-	230	2172,61 €	2411,59 €
PNB1000	1.000	75	-	140	219,82 €	244,00 €
PNB1500	1.500	105	-	140	370,62 €	411,39 €

Modello TIPO PN PANETTONE



Articolo	Litri	Alt.	Lungh.	Largh.	Listino A	Listino B
FOSSA5	Per. 5-10	130	-	103	766,80 €	851,15 €
FOSSA10	Per. 10-20	170	-	168	1086,30 €	1205,80 €
PROL.A	Prol. A	48	-	31	40,90 €	45,39 €
PROL.B	Prol. B	48	-	40	47,29 €	52,49 €

Modello FOSSA



Riservone Tramoggia TRAMOGGIA

Tramoggia

H	Lung.	Larg.
104	50	37

Codice	Riferimenti	Listino A	Listino B	Off.	Box
TRAMOGGIA		173,81 €	192,93 €	1	1



Supporto Tramoggia SUPPORTO

Supporto

H	Lung.	Larg.
65	72	111

Codice	Riferimenti	Listino A	Listino B	Off.	Box
SUPPORTO		201,92 €	224,14 €	1	1



Aqualine Scivolo SCIVOLO

Scivolo

H	Ø Sup.	Ø Inf.
90	43X43	37

Codice	Riferimenti	Listino A	Listino B	Off.	Box
SCIVOLO		33,46 €	37,14 €	1	1



Aqualine Multiuso MULTIUSO

Contenitore Multiuso

H	Lung.	Larg.
100	/	255

Codice	Riferimenti	Listino A	Listino B	Off.	Box
MULTIUSO		132,91 €	147,53 €	1	1

Tino



Tino Contenitore Vino

H	Ø	Litri
101	86	300

Codice	Riferimenti	Listino A	Listino B	Off.	Box
TINO300		188,57 €	209,31 €	1	1



Rubinetto Botte

Codice	Riferimenti	Listino A	Listino B	Off.	Box
RSB12	MM.12	15,48 €	17,19 €	1	1
RSB14	MM.14	15,58 €	17,29 €	1	1
RSB16	MM.16	18,04 €	20,02 €	1	1
RSB18	MM.18	19,54 €	21,69 €	1	1

Giara



Contenitori per Vino



Litri	H.	Larg.	Lung.
47	43	37	54
85	51	47	65
140	58	54	77
184	62	59	84
300	72	68	97
500	102	90	120

Codice	Riferimenti	Listino A	Listino B	Off.	Box
BOTTE50	lt. 47	131,05 €	145,47 €	1	1
BOTTE100	lt. 100	200,76 €	222,85 €	1	1
BOTTE150	lt. 150	227,25 €	252,25 €	1	1
BOTTE200	lt. 200	271,87 €	301,77 €	1	1
BOTTE300	lt. 300	376,43 €	417,84 €	1	1
BOTTE500	lt. 500	508,88 €	564,85 €	1	1

Codice	Riferimenti	Listino A	Listino B	Off.	Box
GIARA300	Lt. 300	161,03 €	178,74 €	1	1
GIARA500	Lt. 500	219,82 €	244,00 €	1	1
GIARA1000	Lt. 1000	408,96 €	453,95 €	1	1



Serbatoi Interrabili

Il Serbatoio Interrabile "SINT", ha un'elevata resistenza meccanica, poiché l'eccezionale spessore delle pareti e l'applicazione di materie prime arricchite con speciali additivi, ne consente l'utilizzo anche in condizioni critiche d'impiego e ad una elevata resistenza al degrado termico.

PER UNA CORRETTA INSTALLAZIONE, SEGUIRE LE REGOLE SOTTO RIPORTATE

- 1) Avvalersi dell'assistenza di un Tecnico abilitato che segua e valuti le caratteristiche del terreno. Il serbatoio non può essere collocato in terreni franosi, pendii, posizioni soggette ad incanalamenti di acque piovane, terreni paludosi.
- 2) Realizzare lo scavo, considerando 30-40 cm su ogni lato, oltre le dimensioni e l'ingombro del Serbatoio.
- 3) **IMPORTANTE:**
 - Per terreni soffici, considerare che l'angolo di scavo non superi i 45°;
 - Per i terreni a media durezza non superi i 60°;
 - Per i terreni rocciosi si possono raggiungere anche gli 80°.
- 4) Il fondo dello scavo deve essere perfettamente livellato, aggiungendo circa 20 cm di misto granulare e sabbia, *compattandola* per evitare lo sprofondamento del Serbatoio. Assicurarsi che non ci siano corpi estranei che possano danneggiare il fondo dello stesso.
- 5) Il Serbatoio **VUOTO**, una volta calato nello scavo tramite gli appositi **GOLFARI** in dotazione, deve essere riempito d'acqua circa la metà, per poi riempire lo scavo fino al livello della stessa, con sabbia compattata a strati di 20-30 cm. Ripetere l'operazione fino a raggiungere l'altezza della Prolunga di Ispezione. Completare la fase d'interro con terreno vegetale.
- 6) **ATTENZIONE:** assicurarsi del corretto funzionamento dello sfisto per far sì che ci sia il flusso d'aria costante nello svuotamento, in presenza di pompe idrauliche.
- 7) La zona dove viene collocato il Serbatoio è pedonabile, ma non è assolutamente carrabile.
- 8) L'interro deve essere fatto manualmente, non con mezzi meccanici.

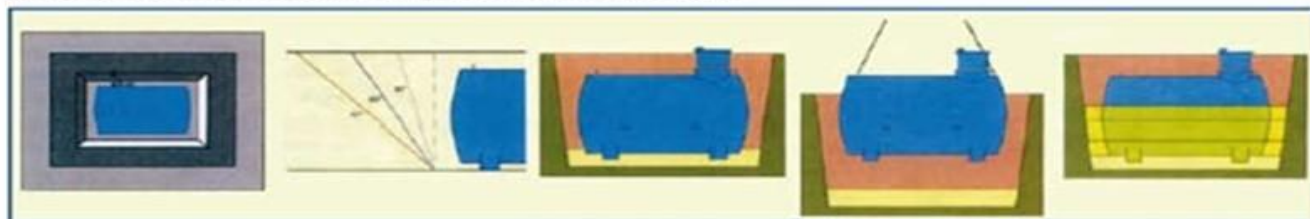

SINT
SERBATOI INTERRABILI

Serbatoio Interrabili

Modello	Lungh.	Largh.	Litri	H	Listino A	Listino B
SINT2000	175	123	2000	130	1105,47 €	1227,08 €
SINT3000	190	148	3000	135	1476,09 €	1638,46 €
SINT5000	230	172	5000	180	2536,84 €	2815,89 €



Prolunga

Modello	Lungh.	Largh.	Litri	Listino A	Listino B
PROLUNGA	/	45	30	Arrivo	Arrivo



Sottoscala

Serbatoio Sottoscala

Modello	Lungh.	Largh.	Litri	Listino A	Listino B
SS500	125	67	500	241,54 €	268,11 €



LA SCELTA FACILE

Caldaie & Scaldabagni



Valvole & Detentori Radiatori

Prodotti per la pulizia caldaia



CORPI VALVOLA - BODY VALVES



CORPI VALVOLA - BODY VALVES



Valvole motorizzate di zona a 2 - 3 vie

Solare

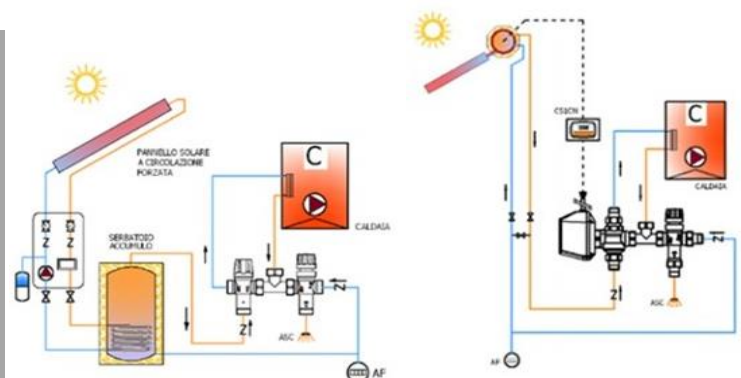



Scaldabagno Bandini Braun
Vetroporcellnatao Vert. 12 Lt
Sopralavello 2 Anni Garanzia
A12SP2A



Codice	Riferimenti	Listino A	Listino B	Off.	Box
A12SP2A		120,66 €	120,66 €	1	1
A12SP2Ax5	Offertax5	114,91 €	114,91 €	5	1
A12SP2Ax10	Offertax10	106,29 €	106,29 €	10	1
A12SP2Ax15	Offertax15	96,53 €	96,53 €	15	1



Scaldabagno Bandini Braun
Vetroporcellnatao Vert. 12 Lt
Sottolavello 2 Anni Garanzia
A12ST7A



Codice	Riferimenti	Listino A	Listino B	Off.	Box
A12ST2A		113,12 €	113,12 €	1	1
A12ST2Ax5	Offertax5	107,73 €	107,73 €	5	1
A12ST2Ax10	Offertax10	99,65 €	99,65 €	10	1
A12ST2Ax15	Offertax15	90,49 €	90,49 €	15	1



30 Lt

Scaldabagno Bandini Braun
Vetroporcellnatao Vert. 30 Lt 2
Anni Garanzia SE302A



Codice	Riferimenti	Listino A	Listino B	Off.	Box
SE302A		170,93 €	170,93 €	1	1
SE302Ax5	Offertax5	162,79 €	162,79 €	5	1
SE302Ax10	Offertax10	150,58 €	150,58 €	10	1
SE302Ax15	Offertax15	136,75 €	136,75 €	15	1



30 Lt

Scaldabagno Bandini Braun
Vetroporcellnatao Vert. 30 Lt
B/30 2 Anni Garanzia B302A



Codice	Riferimenti	Listino A	Listino B	Off.	Box
B302A		154,52 €	154,52 €	1	1
B302Ax5	Offertax5	167,58 €	167,58 €	5	1
B302Ax10	Offertax10	155,01 €	155,01 €	10	1
B302Ax15	Offertax15	140,77 €	140,77 €	15	1



50 Lt

Scaldabagno Bandini Braun
Vetroporcellnatao Vert. 50 Lt 2
Anni Garanzia SE502A



Codice	Riferimenti	Listino A	Listino B	Off.	Box
SE502A		173,45 €	173,45 €	1	1
SE502Ax5	Offertax5	165,19 €	165,19 €	5	1
SE502Ax10	Offertax10	152,80 €	152,80 €	10	1
SE502Ax15	Offertax15	138,76 €	138,76 €	15	1



50 Lt

Scaldabagno Bandini Braun
Vetroporcellnatao Oriz. 50 Lt 2
Anni Garanzia Sx SO502ASX



Dx versione destra

Codice	Riferimenti	Listino A	Listino B	Off.	Box
SO502ASX		198,67 €	198,67 €	1	1
SO502ASXx5	Offertax5	215,46 €	215,46 €	5	1
SO502ASXx10	Offertax10	199,30 €	199,30 €	10	1
SO502ASXx15	Offertax15	180,99 €	180,99 €	15	1



80 Lt

Scaldabagno Bandini Braun
Vetroporcellnatao Vert. 80 Lt 2
Anni Garanzia SE802A



PROMO



Codice	Riferimenti	Listino A	Listino B	Off.	Box
SE802A		201,10 €	223,22 €	1	1
SE802Ax5	Offertax5	191,52 €	212,59 €	5	1
SE802Ax10	Offertax10	177,16 €	196,64 €	10	1
SE802Ax15	Offertax15	160,88 €	178,57 €	15	1



80 Lt

Scaldabagno Bandini Braun
Vetroporcellnatao Oriz. 80 Lt 2
Anni Garanzia Sx SO802ASX



Dx versione destra

Codice	Riferimenti	Listino A	Listino B	Off.	Box
SO802ASX		241,32 €	241,32 €	1	1
SO802ASXx5	Offertax5	229,82 €	229,82 €	5	1
SO802ASXx10	Offertax10	212,59 €	212,59 €	10	1
SO802ASXx15	Offertax15	193,05 €	193,05 €	15	1



80 Lt

Scaldabagno Bandini Braun
Termoelettrico Lt 80 Vert. 2 Anni
Garanzia Dx ST802ADX

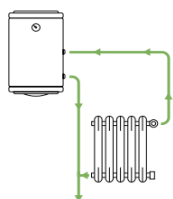

Codice	Riferimenti	Listino A	Listino B	Off.	Box
ST802ADX	80 LT Dx	275,93 €	306,29 €	1	1
ST802ASX	80 LT Sx	275,93 €	306,29 €	1	1



80 Lt

Scaldabagno Bandini a Legna
Elettrico 80 Lt 2 Anni Garanzia
SX0080C2V



Codice	Riferimenti	Listino A	Listino B	Off.	Box
SX0080C2V	80 LT	532,00 €	590,52 €	1	1



Valvola Scald. Pes. Leva
1/2''Mf VSSL1\2

Codice	Riferimenti	Listino A	Listino B	Conf.	Box
VSSL1\2		3,04 €	3,37 €	1	24



Valvola Scald. Con Rid.
Pres. VSRP

Codice	Riferimenti	Listino A	Listino B	Conf.	Box
VSRP		8,42 €	9,34 €	1	12



Resistenza Scaldabagno
Filettato D. 11/4''

Codice	Riferimenti	Listino A	Listino B	Conf.	Box
RDT12	1200 W	9,74 €	10,81 €	1	10
RDT15	1500 W	10,71 €	11,89 €	1	10
RDT20	2000 W	Arrivo	Arrivo	1	10



Resistenza Scaldabagno
Flangiata

Codice	Riferimenti	Listino A	Listino B	Conf.	Box
RDF12	1200 W	9,36 €	10,39 €	1	10
RDF15	1500 W	10,71 €	11,89 €	1	10
RDF20	2000 W	Arrivo	Arrivo	1	10



Resistenza Scaldabagno
Faston Prolungati 1200W
RDAP12

Codice	Riferimenti	Listino A	Listino B	Conf.	Box
RDAP12	1200 W	9,36 €	10,39 €	1	10
RDAP15	1500 W	8,31 €	9,22 €	1	10



Guar. Resistenza Flangia
Pz. 1Zx GRT

Codice	Riferimenti	Listino A	Listino B	Conf.	Box
GRT		0,17 €	0,19 €	1	10



Guarnizione flangia 75
Integrale GCI75

Codice	Riferimenti	Listino A	Listino B	Conf.	Box
GCI75		1,21 €	1,35 €	1	10



Valvola Scald. Pesante
1/2''Mf VSS1\2

Codice	Riferimenti	Listino A	Listino B	Conf.	Box
VSS1\2		2,53 €	2,81 €	1	24



Valvola Multifunzione 3/4''
Mf V1403\4

Codice	Riferimenti	Listino A	Listino B	Conf.	Box
V1403\4		13,66 €	15,17 €	1	6



Resistenza Scaldabagno
Filettato D. 11/4'' Curva

Codice	Riferimenti	Listino A	Listino B	Conf.	Box
RCT12	1200 W	9,31 €	10,33 €	1	10
RCT15	1500 W	8,58 €	9,52 €	1	10



Resistenza Scaldabagno
Flangiata Curva

Codice	Riferimenti	Listino A	Listino B	Conf.	Box
RCF12	1200 W	8,22 €	9,13 €	1	10
RCF15	1500 W	8,58 €	9,52 €	1	10



Resistenza Scaldabagno
Curva Faston Lunghi
1200W RCAP12

Codice	Riferimenti	Listino A	Listino B	Conf.	Box
RCAP12	1200 W	8,30 €	9,21 €	1	10
RCAP15	1500 W	8,58 €	9,52 €	1	10



Termostato Scaldabagno
Univer. TUS

Codice	Riferimenti	Listino A	Listino B	Conf.	Box
TUS		4,81 €	5,34 €	1	10



Termostato Sicurea Rtsr
30Mm RTS3R

Codice	Riferimenti	Listino A	Listino B	Conf.	Box
RTS3R		7,54 €	8,37 €	1	10



Termo arredo Bianco
Brand Sira
o
brand Lazzarini

Codice	Riferimenti	Listino B	Listino B	Box
S45X80B	40 Bianco	69,24 €	76,86 €	5
S45X110B	40 Bianco	64,26 €	71,33 €	5
S45X120B	40 Bianco	84,35 €	93,63 €	5
S45X140B	40 Bianco	92,55 €	102,73 €	5
S45X180B	40 Bianco	Arrivo	Arrivo	5
S50X80B	45 Bianco	66,30 €	73,59 €	5
S50X120B	45 Bianco	88,87 €	98,64 €	5
S50X140B	45 Bianco	109,39 €	121,43 €	5
S50X180B	45 Bianco	Arrivo	Arrivo	5
S55X80B	50 Bianco	71,83 €	79,73 €	5
S55X120B	50 Bianco	95,65 €	106,17 €	5
S55X140B	50 Bianco	90,16 €	100,08 €	5
S55X180B	50 Bianco	Arrivo	Arrivo	5



Termo arredo Cromo
Brand Sira
o
brand Lazzarini

Codice	Riferimenti	Listino B	Listino B	Box
S45X80C	40 Cromo	124,20 €	137,86 €	5
S45X110C	40 Cromo	Arrivo	Arrivo	5
S45X120C	40 Cromo	160,17 €	177,78 €	5
S45X140C	40 Cromo	170,72 €	189,50 €	5
S45X180C	40 Cromo	Arrivo	Arrivo	5
S50X80C	45 Cromo	128,97 €	143,16 €	5
S50X120C	45 Cromo	164,04 €	182,08 €	5
S50X140C	45 Cromo	187,88 €	208,55 €	5
S50X180C	45 Cromo	Arrivo	Arrivo	5
S55X80C	50 Cromo	110,33 €	122,46 €	5
S55X120C	50 Cromo	159,22 €	176,73 €	5
S55X140C	50 Cromo	185,66 €	206,08 €	5
S55X180C	50 Cromo	Arrivo	Arrivo	5

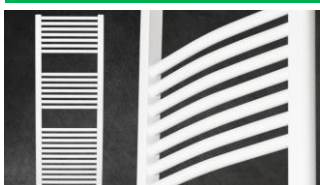

Termo arredo Curvo Bianco
Brand Sira

FLEX WHITE

Codice	Riferimenti	Listino B	Listino B	Box
SC45X80B	40 Bianco	Arrivo	Arrivo	5
SC45X110B	40 Bianco	62,74 €	69,64 €	5
SC45X120B	40 Bianco	Arrivo	Arrivo	5
SC45X140B	40 Bianco	72,27 €	80,21 €	5
SC45X180B	40 Bianco	Arrivo	Arrivo	5
SC50X80B	45 Bianco	Arrivo	Arrivo	5
SC50X120B	45 Bianco	Arrivo	Arrivo	5
SC50X140B	45 Bianco	75,98 €	84,34 €	5
SC50X180B	45 Bianco	Arrivo	Arrivo	5
SC55X80B	50 Bianco	Arrivo	Arrivo	5
SC55X120B	50 Bianco	Arrivo	Arrivo	5
SC55X140B	50 Bianco	80,86 €	89,76 €	5
SC55X180B	50 Bianco	Arrivo	Arrivo	5



Termo arredo Curvo Cromo
Brand Sira

FLEX CHROME

Codice	Riferimenti	Listino B	Listino B	Box
SC45X80C	40 Cromo	Arrivo	Arrivo	5
SC45X110C	40 Cromo	118,27 €	131,28 €	5
SC45X120C	40 Cromo	121,36 €	134,71 €	5
SC45X140C	40 Cromo	173,83 €	192,95 €	5
SC45X180C	40 Cromo	Arrivo	Arrivo	5
SC50X80C	45 Cromo	110,33 €	122,46 €	5
SC50X120C	45 Cromo	159,22 €	176,73 €	5
SC50X140C	45 Cromo	182,36 €	202,42 €	5
SC50X180C	45 Cromo	Arrivo	Arrivo	5
SC55X80C	50 Cromo	Arrivo	Arrivo	5
SC55X120C	50 Cromo	Arrivo	Arrivo	5
SC55X140C	50 Cromo	165,68 €	183,90 €	5
SC55X180C	50 Cromo	Arrivo	Arrivo	5



Scaldasalvietta Elettrica
Bolzano Ds2 Dr Bianco

[E-BOLZANO - Manuale istruzioni.pdf](#)
[E-BOLZANO - scheda tecnica.pdf](#)

Scaldasalvietta Elettrica
Bolzano Ds2 Dr Bianco

Codice	Riferimenti	Listino B	Listino B	Box
S50X80BE	50	249,50 €	276,94 €	2
S50X120BE	50	268,65 €	298,20 €	2
S50X160BE	50	283,14 €	314,28 €	2
S50X180BE	50	303,85 €	337,27 €	2
S60X120BE	60	280,02 €	310,83 €	2
S60X160BE	60	299,19 €	332,11 €	2
S60X180BE	60	338,01 €	375,19 €	2



Radiatore Alluminio Modello Primavera



Codice	Riferimenti	Listino A	Listino B	Off.	Box
P500	500	12,40 €	13,77 €	1	1
P600	600	19,88 €	22,07 €	1	1

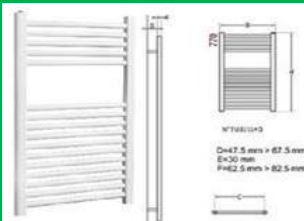

Termo Arredo Import 40 int. Per 80 cm. H. colore Bianco

Import Export

Codice	Riferimenti	Listino A	Listino B	Off.	Box
S45X80OF	40 Bianco	24,54 €	27,24 €	1	1

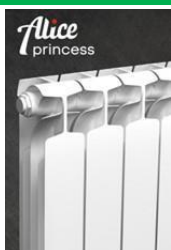

Radiatore Alluminio Modello Alice Princess



Codice	Riferimenti	Listino A	Listino B	Off.	Box
AP50	500 580	20,28 €	22,51 €	1	10
AP60	600 680	21,93 €	24,35 €	1	10
AP70	700 780	23,50 €	26,08 €	1	10
AP80	800 880	25,38 €	28,18 €	1	10



Radiatore Alluminio Modello Alice Royal



Codice	Riferimenti	Listino A	Listino B	Off.	Box
AR50	500 580	20,28 €	22,51 €	1	10
AR60	600 680	21,93 €	24,35 €	1	10
AR70	700 780	23,50 €	26,08 €	1	10
AR80	800 880	25,38 €	28,18 €	1	10



Radiatore Alluminio Modello Alice+



Codice	Riferimenti	Listino A	Listino B	Off.	Box
A+100	1000 1060	69,28 €	76,90 €	1	2+3
A+120	1200 1260	76,18 €	84,56 €	1	2+3
A+140	1400 1460	81,61 €	90,59 €	1	2+3
A+160	1600 1660	88,60 €	98,35 €	1	2+3
A+180	1800 1860	93,03 €	103,26 €	1	2+3
A+200	2000 2060	102,00 €	113,23 €	1	2+3



Radiatore Alluminio Modello Rubino



Codice	Riferimenti	Listino A	Listino B	Off.	Box
R100	1000 1060	62,31 €	69,16 €	1	5
R120	1200 1260	67,18 €	74,57 €	1	5
R140	1400 1460	72,03 €	79,95 €	1	5
R160	1600 1660	76,90 €	85,36 €	1	5
R180	1800 1860	81,65 €	90,64 €	1	5
R200	2000 2060	89,77 €	99,64 €	1	5



Tubi scorrimento acqua
Steel water hoses

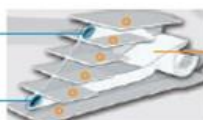

Superficie esterna
in alluminio pressofuso
Outer surface in
pressure Die-Cast aluminium



Codice	Inter.-Finale	D.30-D.50	Listino A	Listino B	Diametro connessioni 1"
RS3	300 372	44 86	24,94 €	27,68 €	Larghezza elemento 80 mm
RS5	500 572	61 121	26,15 €	29,03 €	Colore di serie bianco RAL 9010 Sira Industrie
RS6	600 672	69 138	35,39 €	39,28 €	20 anni di garanzia
RS7	700 772	77 156	35,90 €	39,85 €	Gli elementi vengono assemblati in batterie da 4 a 12.
RS8	800 872	86 172	43,24 €	48,00 €	Pressione massima d'esercizio è di 4000 kPa (40 bar)

Codice	Riferimenti	Listino A	Listino B
Z1KTMRSI	Coppia Mensole	11,09 €	12,31 €
XIKT38SM	Kit tappi	5,45 €	6,05 €





Scaldabagno A Gas
Camera Stagna Mini

Scheda Tecnica



Codice	Riferimenti	Listino A	Listino B	Conf.	Box
8112631	12 Lt. Gpl	559,93 €	621,52 €	1	12
8112630	12 Lt. Met	559,93 €	621,52 €	1	12
8112632	16 Lt. Gpl	686,14 €	761,62 €	1	12
8112633	16 Lt. Met	686,14 €	761,62 €	1	12



Caldia Sime VERA a
Condensazione

Scheda Tecnica



Codice	Riferimenti	Listino A	Listino B	Conf.	Box
VERAHE25	25 KW	1459,94 €	1620,54 €	1	6
VERAHE30	30 KW	1795,01 €	1992,47 €	1	6



Scaldabagno Bandini
Braun Volano Termico
Sep 5 anni di garanzia

Scheda Tecnica



Codice	Riferimenti	Listino A	Listino B	Conf.	Box
SV30C5VSEP	30 Lt.	366,88 €	407,23 €	1	12
SV50C5VSEP	50 Lt.	395,02 €	438,47 €	1	8
SV80C5VSEP	80 Lt.	418,26 €	464,26 €	1	6
SV100C5VSEP	100 Lt.	460,08 €	510,69 €	1	4



Kit scarico orizzontale 60/100
per caldaia Sime 8096250



SCARICO FUMI
CONDENSAZIONE

Codice	Riferimenti	Listino A	Listino B	Off.	Box
8096250	solo con caldaia	47,87 €	53,13 €	1	24
ALCKITU1D60-100	Universale	65,48 €	72,68 €	1	24



Junkers Scaldabagno
Therm 4204 Nox Lt 10

Codice	Riferimenti	Listino A	Listino B	Conf.	Box
7736504907	Metano	338,63 €	375,88 €	1	12
7736504909	Gpl	338,63 €	375,88 €	1	12



Caldia Sime VERA a
Condensazione

Scheda Tecnica



Codice	Riferimenti	Listino A	Listino B	Conf.	Box
VERAHE25	25 KW	1459,94 €	1620,54 €	1	6



Scheda
Tecnica



Installabile a muro nella versione 110 lt. e a basamento nelle versioni 200 e 300 litri. Serbatoio in acciaio con vetrificazione a doppio strato. Anodo di magnesio anticorrosione sostituibile. Serpentino di riscaldamento avvolto esternamente al bollitore. Funzione anti-legionella automatica. Elevata silenziosità. Serpentino interno per collegamento ad impianto solare termico (versione 300 S). Contatto per integrazione con impianto fotovoltaico. Resistenza elettrica integrata per assicurare comfort anche nelle condizioni più estreme. Il prodotto raggiunge i requisiti necessari ai fini della detrazione fiscale del 65% e 110%

Codice	Riferimenti	Listino A	Listino B	Off.	Box
8115842	Lt 110	1775,39 €	1970,68 €	1	1
8115843	Lt 200	2539,79 €	2819,17 €	1	1
8115846	Lt 200 S	2704,49 €	3001,98 €	1	1
8115845	Lt 300 S	3032,96 €	3366,58 €	1	1

Kit scarico orizzontale 60/100
Universale convenzionale



SCARICO FUMI
CONVENZIONALI

KSFTV

Codice	Riferimenti	Listino A	Listino B	Off.	Box
KSFTV		49,72 €	55,19 €	1	24



Coppia Valvola Squadra Lusso
Bianco uscita da 1/2"



Codice	Riferimenti	Listino A	Listino B	Off.	Box
200TBD12	D. 1/2"	29,96 €	33,25 €	1	5
200TBDM16	1/2"x 16 multistrato	51,88 €	57,59 €	1	5



Valvola Arredo A Squadra Attacco A
Compressione 1/2X1/2 Destra
/Sinistra Finitura Bianca Cromo



Codice	Riferimenti	Listino A	Listino B	Off.	Box
230TB015S	D. 1/2" Sx	27,57 €	30,61 €	1	5
230TB015D	D. 1/2" Dx	27,57 €	30,61 €	1	5



Kit Valvolva E Detentore Con
Testina Termostatica Bianca
Senza Dadi Di Serraggio
100KB015



Codice	Riferimenti	Listino A	Listino B	Off.	Box
100KB015	D. 1/2"	59,81 €	66,39 €	1	5



Kit Valvolva E Detentore
Con Testina Termostatica
Bianca Senza Dadi Di
Serraggio Destro/Sinistro



Codice	Riferimenti	Listino A	Listino B	Off.	Box
135KB015D	D. 1/2" Dx	81,33 €	90,28 €	1	5
130KB015S	D. 1/2" Sx	74,39 €	82,57 €	1	5



Kit Valvolva E Detentore Nera
Senza Dadi Di Serraggio Sx
230NN015S



Codice	Riferimenti	Listino A	Listino B	Off.	Box
230NN015S	1/2"X1/2"	54,15 €	60,10 €	1	5
230NN015D	1/2"X1/2"	54,15 €	60,10 €	1	5



Coppia Valvola Sq. Lusso Nera
Attacco 1/2" Tasc D. 16 Senza
Dadi 200KNN015



Codice	Riferimenti	Listino A	Listino B	Off.	Box
200KNN015	1/2"X1/2"	52,63 €	58,42 €	1	5



Kit Valvolva E Detentore Con
Testina Termostatica Nera Senza
Dadi Di Serraggio 100KNNR015



Codice	Riferimenti	Listino A	Listino B	Off.	Box
100KNNR015		59,81 €	66,39 €	1	5



Kit Valvolva E Detentore
Con Testina Termostatica
Nera Senza Dadi Di
Serraggio Dx-Sx



Codice	Riferimenti	Listino A	Listino B	Off.	Box
135KNN015D	Dx	75,09 €	83,35 €	1	5
130KNN015S	Sx	75,09 €	83,35 €	1	5



Coppia Valvola Sq. Lusso Cromo
Attacco Rame D.1/2" Tasca 16 X
12 Mm Rame 200TAD12



Codice	Riferimenti	Listino A	Listino B	Off.	Box
200TAD12	D. 1/2"	29,96 €	33,25 €	1	5
200TADM16	1/2"x 16 multistrato	44,68 €	49,60 €	1	5



Valvola Arredo A Squadra
Attacco A Compressione
1/2X1/2 Sinistra Finitura Cromo
230TA015S



Codice	Riferimenti	Listino A	Listino B	Off.	Box
230TA015S	D. 1/2" Sx	21,63 €	24,01 €	1	5
230TA015D	D. 1/2" Dx	21,63 €	24,01 €	1	5



Kit Valvolva E Detentore Con
Testina Termostatica Cromo
Senza Dadi Di Serraggio
100KC015



Codice	Riferimenti	Listino A	Listino B	Off.	Box
100KC015	D. 1/2"	59,81 €	66,39 €	1	5



Kit Valvolva E Detentore
Con Testina Termostatica
Cromo Senza Dadi Di
Serraggio Dx-Sx



Codice	Riferimenti	Listino A	Listino B	Off.	Box
135KC015D	D. 1/2" Dx	75,31 €	83,59 €	1	5
130KC015S	D. 1/2" Sx	75,31 €	83,59 €	1	5



Kit Termostatico Valvola +
Detentore+ Testina
Cromata 842+942+Testa
Termostatica Uscita 1/2" Attacco
1/2" Tasca 16 82KITAAD061100



Codice	Riferimenti	Listino A	Listino B	Off.	Box
82KITAAD061100	M.1/2"-M.3/8"	29,30 €	32,52 €	1	5



Kit Termostatico 842+942
Valvola + Detentore Senza
Testina Uscita 1/2" Attacco 1/2"
Tasca 16 82KITAAD



Codice	Riferimenti	Listino A	Listino B	Off.	Box
82KITAAD	M.1/2"-M.1/2"	14,42 €	16,01 €	1	5



Valvola + Detentore 3/8"
Usc.1/2" V+DEI

Codice	Riferimenti	Listino A	Listino B	Off.	Box
V+DEI	M.1/2"-M.3/8"	8,68 €	9,63 €	1	5



Valv. + Det. 3/8 Retta Uscita
3/8" Femmina V+DR3\8

Codice	Riferimenti	Listino A	Listino B	Off.	Box
V+DR3\8	M.3/8"-F.3/8"	18,22 €	20,22 €	1	5



Kit Dado Completo 1/2" X 10
KCD10

Codice	Riferimenti	Listino A	Listino B	Off.	Box
KCD10	1/2"xRame 10	1,73 €	1,92 €	1	5
KCD12	1/2"xRame 12	1,73 €	1,92 €	1	5



Valvola + Dent. Retta 3/8" X1/2
Tasca D. 16 V+DR

Codice	Riferimenti	Listino A	Listino B	Off.	Box
V+DR	M.1/2"-M.3/8"	8,85 €	9,82 €	1	5



Inserti X Multistrato Da 16X2
I16M

Codice	Riferimenti	Listino A	Listino B	Off.	Box
I16M	1/2"xMult. 16	1,42 €	1,57 €	1	5



Dado Completo Lusso 1/2"X12
Per Valvola 200Tad12 9100TA12

Codice	Riferimenti	Listino A	Listino B	Off.	Box
9100TA12	1/2"xRame 12	3,12 €	3,46 €	1	5



Dado Completo Lusso 1/2X16X2
Per Valvola 200Tadm16
9200TAM16

Codice	Riferimenti	Listino A	Listino B	Off.	Box
9200TAM16	1/2"xMult. 16	3,31 €	3,68 €	1	5



Valvolina Sfiato Aria Da 1/4
VSA1\4

Codice	Riferimenti	Listino A	Listino B	Off.	Box
VSA1\4	D. 1/4"	0,73 €	0,81 €	1	5
VSA3\8	D. 3/8"	0,77 €	0,86 €	1	5



Niples Radiatore Dx - Sx D. 1"
NR1

Codice	Riferimenti	Listino A	Listino B	Off.	Box
NR1	D. 1"	0,33 €	0,37 €	1	5



Chiave Universale
Assemblaggio Radiatori
CHIASR

Codice	Riferimenti	Listino A	Listino B	Off.	Box
CHIASR	D. 1"	14,68 €	16,29 €	1	5



Dosamax Blu Stop Ghiera
1/2" DBSG

Codice	Riferimenti	Listino A	Listino B	Off.	Box
DBSG		37,45 €	41,57 €	1	5
DBSG5	Off.x5	34,39 €	38,17 €	1	5



Dosatore Polifosfati Ghiera
1/2" DBSS

Codice	Riferimenti	Listino A	Listino B	Off.	Box
DBSS		37,30 €	41,40 €	1	5
DBSS5	Off.x5	34,25 €	38,02 €	1	5



Filtro Defangatore Magnetico
HSDPL

Codice	Riferimenti	Listino A	Listino B	Off.	Box
HSDPL		42,51 €	47,19 €	1	5
HSDPL5	Off.x5	39,04 €	43,33 €	1	5



Defangatore F/F per impianti di riscaldamento e raffreddamento dotato di rubinetto di scarico a sfera con portagomma. Pressione max d'esercizio 10 bar, temperatura max d'esercizio 110°C, rete in acciaio inox.

Codice	Riferimenti	Listino A	Listino B	Off.	Box
82747AE05	D. 3/4"	59,99 €	66,59 €	1	5
82745AF05	D. 1"	65,33 €	72,51 €	1	5



Kit Salvacaldaie: Composta Da Defangatore Magnetico, Filtro Neutralizzatore Di Condensa, Dosatore Polifosfati 10112045

Codice	Riferimenti	Listino A	Listino B	Off.	Box
10112045	1	110,67 €	122,84 €	1	5
101120455	5	101,64 €	112,82 €	1	5

BSA3\8B Boccetta Sfiato Aria Aut.
3/8" BSA3\8B



Valvola automatica di sfogo aria a gomito. D. 1/2" 82715AD06



Codice	Riferimenti	Listino A	Listino B	Off.	Box
BSA3\8B	D. 3/8"	2,95 €	3,28 €	1	5
82715AD06	D. 1/2"	41,79 €	46,39 €	1	5



Rosetta Riscal. Gambo Lungo
Bianca " RARU

Codice	Riferimenti	Listino A	Listino B	Off.	Box
ER1	3/8"x1cm	3,55 €	3,94 €	1	5
ER2	3/8"x2cm	3,82 €	4,24 €	1	5
ER3	3/8"x3cm	6,61 €	7,34 €	1	5
ER4	3/8"x4cm	7,33 €	8,13 €	1	5
ER5	3/8"x5cm	8,01 €	8,89 €	1	5



Chiave Universale Per Tappi Radiatori DRACHIAVE

Codice	Riferimenti	Listino A	Listino B	Off.	Box
RARU		0,1611 €	0,1788 €	1	5



Kit Radiatore Bianco 1"x1/2"
SK1D

Codice	Riferimenti	Listino A	Listino B	Off.	Box
SK1C	1"x3/8"	3,80 €	4,21 €	1	5
SK1D	1"x1/2"	4,78 €	5,31 €	1	5



Maxpoliquick Per Dosatori Proporzion. Ricariche 6 Pz 10160300

Codice	Riferimenti	Listino A	Listino B	Off.	Box
10160300	1	5,59 €	6,20 €	1	10
1016030010	10	5,13 €	5,70 €	10	10



Valvola Sicurezza per Caldaia Bar Maschio

Codice	Riferimenti	Listino A	Listino B	Off.	Box
VSC1\23	3 bar	6,05 €	6,71 €	1	5
VSC1\26	6 bar	7,54 €	8,37 €	1	5
VSC1\28	8 bar	13,48 €	14,96 €	1	5
VSC1\210	10 bar	13,48 €	14,96 €	1	5



Gruppo Riempimento 1/2" C
/M. GR1\2M

Codice	Riferimenti	Listino A	Listino B	Off.	Box
GR1\2M	D. 1/2"	36,43 €	40,44 €	1	5



Pressostato Fantinicosmi
B01B 2 - 5,5 Bar Fantini
Cosmi B01B

Codice	Riferimenti	Listino A	Listino B	Off.	Box
B01B		43,60 €	48,40 €	1	5



Termomanometro Bimetallico A
Contatto 120° D. 62 BRC63VI

Codice	Riferimenti	Listino A	Listino B	Off.	Box
BRC63VI	D. 1/4"	15,94 €	17,69 €	1	5

Termostato ambiente



meccanico

Termostato Ambiente Con Spia
TA020

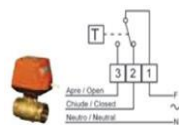

Codice	Riferimenti	Listino A	Listino B	Off.	Box
TA020		19,48 €	21,63 €	1	5



Valvole Di Bilanciamento Per
Circuiti Idraulici,
Compensatori Idraulici E
Tronchetti D. 1" 1/2

Codice	Riferimenti	Listino A	Listino B	Off.	Box
92C303AF06	D. 1"	178,05 €	197,63 €	1	5
92C303AG06	D. 1 1/4"	255,19 €	283,27 €	1	5
92C303AH06	D. 1 1/2"	333,96 €	370,70 €	1	5
	D. 2"	Arrivo	Arrivo	1	5



Esalatore Fumi Colore
Bianco

Codice	Riferimenti	Listino A	Listino B	Off.	Box
E110	D. 110	19,93 €	22,12 €	1	12
E120	D. 120	19,93 €	22,12 €	1	12
E130	D. 130	19,93 €	22,12 €	1	12
E140	D. 140	19,93 €	22,12 €	1	12



Termostato A Contatto
Termostato Regolabile In
Custodia Plastica A Contatto
Cewal. Tusc 91934010 TUSC

Codice	Riferimenti	Listino A	Listino B	Off.	Box
TUSC	91934010 cewal	15,18 €	16,85 €	1	5



Termostato A Immersione Cewal
Ture 30/90° 10Cm TURE

Codice	Riferimenti	Listino A	Listino B	Off.	Box
TURE		20,75 €	23,03 €	1	5



Termostato A Contatto Cewal
Termostati Di Regolazione A
Capillare
Termostato Regolabile 0/90°C

Codice	Riferimenti	Listino A	Listino B	Off.	Box
TUREC		17,96 €	19,94 €	1	5



Neutralizzatore Acida Di
Condensa Caldaie Attacco 3/4" -
3/4" M H. 220 X L. 47 Mm
NEUTRAWATER-B

Codice	Riferimenti	Listino A	Listino B	Off.	Box
NEUTRAWATER-B	1	20,75 €	23,03 €	1	5



Separatore Aria 1 1/2" 110167

Codice	Riferimenti	Listino A	Listino B	Off.	Box
110165	D. 1"	50,60 €	56,17 €	1	5
110166	D. 1 1/4"	72,95 €	80,97 €	1	5
110167	D. 1 1/2"	89,42 €	99,25 €	1	5
110168	D. 2"	108,24 €	120,15 €	1	5

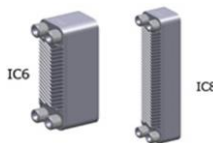

Scambiatori Istantanei
Attacco 3/4" A 30 Piastre
315X73X72 IC830

Codice	Riferimenti	Listino A	Listino B
IC814	14 Piastre 315X73X36	150,55 €	167,11 €
IC820	20 Piastre 315X73X50	177,11 €	196,60 €
IC830	30 Piastre 315X73X72	222,66 €	247,15 €
IC840	40 Piastre 315X73X94	268,20 €	297,70 €
IC630	30 Piastre 210X73X72	177,11 €	196,60 €
IC630	30 Piastre 210X73X72	177,11 €	196,60 €



Copriscaldaia -
Copriscaldino



Copriscaldaia -
Copriscaldino Uscita
Laterale

Codice	H	L	P	Listino A	Listino B
P160P	800	480	300	49,21 €	54,62 €
P167P	BC85	850	500	61,03 €	67,74 €
P170P		870	500	75,35 €	83,63 €
BC102S	BC102S	920	500	Arrivo	Arrivo
P200P	BC102	1020	550	81,14 €	90,07 €
P213P	BC108	1060	600	81,14 €	90,07 €
P236P	BC125	1200	600	101,32 €	112,47 €

Codice	H	L	P	Listino A	Listino B
P160PL	800	480	300	49,21 €	54,62 €
P167PL	BC85L	850	500	61,03 €	67,74 €
P170PL		870	500	75,35 €	83,63 €
BC102SL	BC102SL	920	500	Arrivo	Arrivo
P200PL	BC102L	1020	550	81,14 €	90,07 €
P213PL	BC108L	1060	600	81,14 €	90,07 €
P236PL	BC125L	1200	600	101,32 €	112,47 €



Vaso espansione aperto
zincato prof. 260
Bianco

WATERBOX



Vaso espansione aperto
zincato prof. 260
Bianco

Codice	Riferimenti	Listino A	Listino B	Off.	Box
WATERBOX Bianco		36,75 €	40,80 €	1	1

27,5-43,5 CM.

Codice	Riferimenti	Listino A	Listino B	Off.	Box
EVEC2Z	20 lt 21x41	39,48 €	43,82 €	1	1
EVEC3Z	30 lt 31x41	43,56 €	48,35 €	1	1
EVEC4Z	40 lt 41x41	47,64 €	52,88 €	1	1
EVEC5Z	50 lt 51x41	51,73 €	57,42 €	1	1



Tubo Alluminio
Estensibile



Cassetta Box per Acqua

Codice	Riferimenti	Listino A	Listino B	Off.	Box
TA80	mm 80	10,95 €	12,16 €	1	10
TA100	mm 100	12,89 €	14,31 €	1	10
TA120	mm 120	15,58 €	17,30 €	1	10
TA130	mm 130	16,54 €	18,36 €	1	10
TA140	mm 140	18,47 €	20,50 €	1	6
TA150	mm 150	19,47 €	21,62 €	1	6
TA160	mm 160	20,70 €	22,98 €	1	6
TA180	mm 180	23,71 €	26,32 €	1	6
TA200	mm 200	25,90 €	28,75 €	1	4
TA300	mm 300	44,66 €	49,58 €	1	1

Codice	Riferimenti	Listino A	Listino B	Off.	Box
SA3040Z	30x40x20	16,27 €	18,06 €	1	1
SA4060Z	40x60x20	19,13 €	21,23 €	1	1



Cassetta Box per Acqua

Codice	Riferimenti	Listino A	Listino B	Off.	Box
BA3040Z	30X40X23	Arrivo	Arrivo	1	1



Cassetta Box per Gas



Sportello per Gas

Codice	Riferimenti	Listino A	Listino B	Off.	Box
CGG00Z	H45 L30 P23	17,31 €	19,21 €	1	1
CGG01Z	H45 L35 P23	25,86 €	28,71 €	1	1
CGG04Z	H50 L40 P23	31,88 €	35,38 €	1	1
CGG05Z	H60 L40 P23	32,71 €	36,30 €	1	1

Codice	Riferimenti	Listino A	Listino B	Off.	Box
SG4535Z	45x35x20	14,94 €	16,58 €	1	1
SG5030Z	50x35x20	14,94 €	16,58 €	1	1
SG5040Z	50x40x20	16,40 €	18,20 €	1	1
SG6040Z	60x40x20	17,39 €	19,30 €	1	1
SG7040Z	70x40x20	18,86 €	20,93 €	1	1

Condensazione



Prolunga Coassiale Mf 50 D.
60/100 107611

Codice	Riferimenti	Listino A	Listino B
107611	Ø 60 /100 MF X 50 cm	28,59 €	31,74 €
107612	Ø 60 /100 MF X 100 cm	40,08 €	44,49 €



Curva Coassiale
Condensazione D. 60-100 90°
107613

Codice	Riferimenti	Listino A	Listino B
107613	Ø 60 /100	32,20 €	35,74 €



Curva Coassiale
Condensazione D. 60-100 45°
107614

Codice	Riferimenti	Listino A	Listino B
107614	Ø 60 /100	29,18 €	32,39 €



EUR4508B Curva 45° Mf D. 80 Bianco Per Caldaia
Condensazione EUR4508B

EUR9008B Curva 90° Mf D. 80 Bianca Per Caldaia
Condensazione EUR9008B

Codice	Riferimenti	Listino A	Listino B
EUR4508B	Ø 80	7,00 €	7,77 €
EUR9008B	Ø 80	9,96 €	11,06 €



EUR85MFB Tubo Euro 0,5 Mt D.80 Bianco EUR85MFB

EUR81MFB Tubo Euro 1 Mt D.80 Bianco EUR81MFB

Codice	Riferimenti	Listino A	Listino B
EUR85MFB	Ø 80	9,97 €	11,07 €
EUR81MFB	Ø 80	Arrivo	Arrivo



Camino verticale coassiale Ø 60/100
Vertical coaxial chimney Ø 60/100

Camino Verticale Coassiale Ø 60/100
Da Abbinare Partenza
Caldaia PACTT01

Codice	Riferimenti	Listino A	Listino B
PACTT01		80,32 €	89,15 €



107592 Partenza Coassiale
Partenza M/F D. 60/100

107593 Compatibilità: Argo-Baxi-Roca-Viesmann-
Partenza Coassiale
Partenza M/F D. 60/100

Compatibilità: Aristonvaillant-

Codice	Riferimenti	Listino A	Listino B
107592	Ø 60 /100 MF	38,33 €	42,55 €
107593	Ø 60 /100 MF	Arrivo	Arrivo



107594 Partenza Coassiale
Partenza M/F D. 60/100

Compatibilità: Immergas 107594

107596 Partenza Coassiale
Partenza M/F D. 60/100

Compatibilità: Junckersbuderus 107596

Codice	Riferimenti	Listino A	Listino B
107594	Ø 60 /100 MF	27,43 €	30,44 €
107596	Ø 60 /100 MF	41,92 €	46,53 €



107591 Partenza Coassiale
Partenza M/F D. 60/100

Compatibilità: Sime-Italthermbaltur-

107592 Partenza Coassiale
Partenza M/F D. 60/100

Compatibilità: Argo-Baxi-Roca-Viesmann-

Codice	Riferimenti	Listino A	Listino B
107591	Ø 60 /100 MF	34,98 €	38,83 €
107592	Ø 60 /100 MF	38,33 €	42,55 €

Convenzionale



Kit Prolun. Coassiale 60-100
Cm 50 KPC650B

Codice	Riferimenti	Listino A	Listino B
KPC650B	Ø 60 /100 MF X 50 cm	27,10 €	30,08 €
KPC610B	Ø 60 /100 MF X 100 cm	46,94 €	52,10 €



Curva 90° Coassiale 60-100
Per Caldaie Convenzionali
KCC610B1

Codice	Riferimenti	Listino A	Listino B
KCC610B1	Ø 60 /100	38,86 €	43,14 €



Curva Coassiale 60/100 45° Per
Caldaie Covenzionali
CCP61045MFB

Codice	Riferimenti	Listino A	Listino B
CCP61045MFB	Ø 60 /100	23,53 €	26,12 €



CL100B Collare Fascetta Murale Acciaio Zincato
Verniciato Bianco Da 100 CL100B

0

Codice	Riferimenti	Listino A	Listino B
CL100B	Ø 100	5,97 €	6,62 €



FMPV10SV Manicotto & Fascetta Ff D. 100 Con
Guarnizione In Gomma FMPV10SV

0

Codice	Riferimenti	Listino A	Listino B
FMPV10SV	Ø 100	6,01 €	6,67 €



Raccordi Collegamento 60-
100 FMCC610B

Codice	Riferimenti	Listino A	Listino B
FMCC610B	Ø 60 /100	10,93 €	12,13 €



RCEP08 Rosone Coprimuro Epdm D. 80 RCEP08

RCEP10 Rosone Opritubo D. 100
Gomma Bianca RCEP10

Codice	Riferimenti	Listino A	Listino B
RCEP08	Ø 80	7,54 €	8,37 €
RCEP10	Ø 100	5,31 €	5,90 €



10065P Griglia Di Aspirazione/Antintrusione in PP D80
10065P

0

Codice	Riferimenti	Listino A	Listino B
10065P	Ø 80	5,39 €	5,98 €



TERM081 Terminale Inox Da 80 TERM081

PABGS01D80 Terminale Plastica Da 80 PABGS01D80

Codice	Riferimenti	Listino A	Listino B
TERM081	Ø 80 Inox	9,24 €	10,25 €
PABGS01D80	Ø 80 Bianco	6,35 €	7,05 €

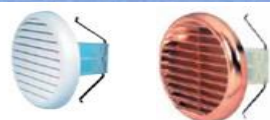
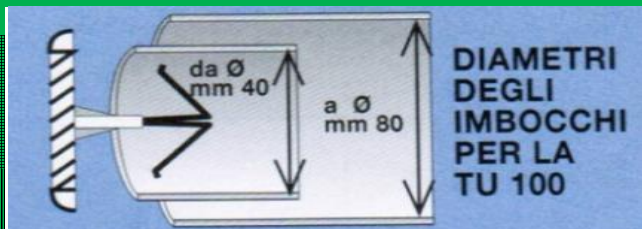

Griglia Aereazione Plastica con molla

Codice	Riferimenti	Listino A	Listino B	Off.	Box
TUR100B	40<->80 B.	2,25 €	2,50 €	1	1
TUR125B	80<->125 B.	1,08 €	1,20 €	1	1
TUR125RA	80<->125 R.	4,76 €	5,28 €	1	1
TUR125CR	80<->125 CR.	4,76 €	5,28 €	1	1

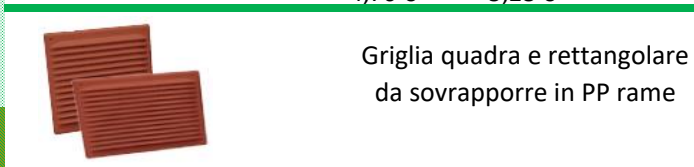

Griglia quadra e rettangolare da sovrapporre in PP rame

Codice	Riferimenti	Listino A	Listino B	Off.	Box
GR200150R	200x150	0,00 €	0,00 €	1	1
GR370130R	370x130	0,00 €	0,00 €	1	1
GQS230230R	230x230	0,00 €	0,00 €	1	1
GRS500230R	500x230	0,00 €	0,00 €	1	1



Aspiratore elicoidale Universale

Codice	Riferimenti	Listino A	Listino B	Off.	Box
AE100M	D. 100	22,42 €	24,88 €	1	1
AE125M	D. 125	25,40 €	28,20 €	1	1
AE150M	D. 150	44,18 €	49,04 €	1	1

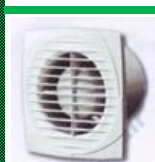

Aspiratore elicoidale Universale

Codice	Riferimenti	Listino A	Listino B	Off.	Box
AE100D	D. 100	21,03 €	23,34 €	1	1
AE125D	D. 125	24,04 €	26,68 €	1	1
AE150D	D. 150	37,35 €	41,45 €	1	1



Aspiratore elicoidale Universale

Codice	Riferimenti	Listino A	Listino B	Off.	Box
COLIBRI100	D. 100	13,41 €	14,89 €	1	1

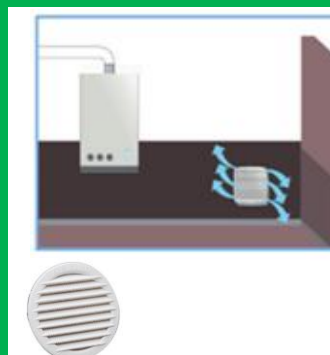
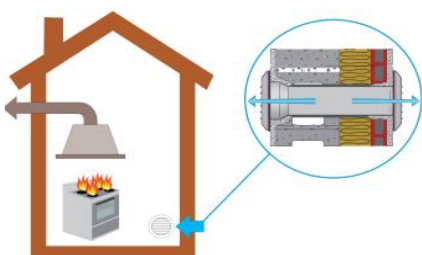

Griglia tonda da incasso PP bianco

Codice	Riferimenti	Listino A	Listino B	Off.	Box
GT63	D. 63	0,30 €	0,33 €	1	1
GT80	D. 80	0,35 €	0,39 €	1	1
GT100	D. 100	0,77 €	0,86 €	1	1
GT160	D. 160	1,72 €	1,91 €	1	1

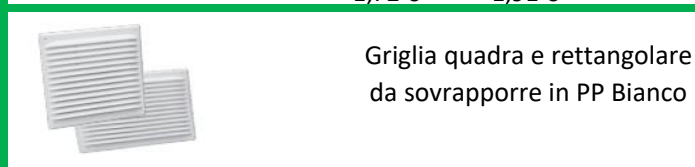

Griglia quadra e rettangolare da sovrapporre in PP Bianco

Codice	Riferimenti	Listino A	Listino B	Off.	Box
GR2015	200x150	1,21 €	1,35 €	1	1
GR3713	370x130	1,38 €	1,53 €	1	1
GQS2323	230x230	1,46 €	1,62 €	1	1
GRS5023	500x230	3,08 €	3,41 €	1	1

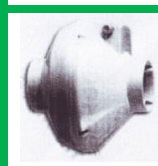

VENTILATORE CENTRIFUGO 100VK

Codice	Riferimenti	Listino A	Listino B	Off.	Box
VC100VK	D. 100	104,75 €	116,27 €	1	1
VC125VK	D. 125	113,86 €	126,38 €	1	1
VC150VK	D. 150	168,51 €	187,05 €	1	1

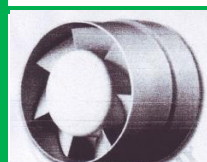

ASPIRATORE ASSIALE DA INTUBARE

Codice	Riferimenti	Listino A	Listino B	Off.	Box
AA100VKO	D. 100	20,04 €	22,24 €	1	1
AA125VKO	D. 125	23,40 €	25,98 €	1	1
AA150VKO	D. 150	30,97 €	34,38 €	1	1

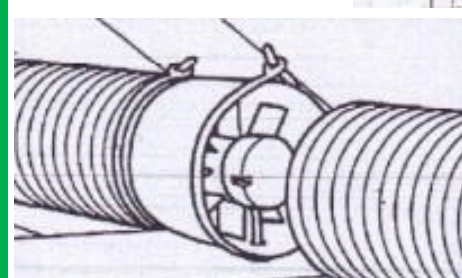
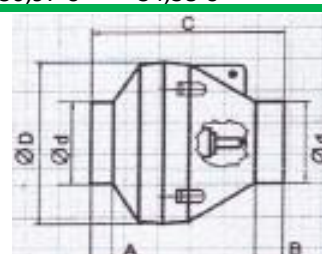

La termostufa modello "SOFIA" è disponibile in varie potenze che vanno dai da 18 kW fino a 26 kW. Si distingue per la sua elevata autonomia (circa 40 kg di pellet) e per le sue prestazioni (92% di rendimento). Con linee pulite e decise questa stufa si armonizza con gli ambienti contemporanei. Camera di combustione di spessore 5mm, affidabilità, sicurezza, possibilità di programmare accensioni e spegnimenti in maniera autonoma, facilità di pulizia; completano la stufa rendendola un prodotto di alta qualità.



A	B	C
674	955	1236
D	E	F
1573	1910	2023



CERTIFICAZIONE
EN 14785
Norma europea di riferimento per le stufe a pellet



beige



bordeaux



antracite

Dimensioni



Codice	Riferimenti	Listino A	Listino B	Off.	Box
SOFIA18BI	Bianca	2974,26 €	3301,43 €	1	1
SOFIA18BO	Bordeaux	2974,26 €	3301,43 €	1	1

Elemento Lineare D. 80

Codice	Riferimenti	Listino A	Listino B	Off.	Box
103971E	L. 0,25	15,59 €	17,30 €	1	1
103972E	L. 0,50	15,74 €	17,47 €	1	1
103973E	L. 1,00	25,40 €	28,20 €	1	1

Elemento Telescopico D. 80

Codice	Riferimenti	Listino A	Listino B	Off.	Box
103969	L. 0,25	33,22 €	36,88 €	1	1

Curva 45° D. 80 Nero

Codice	Riferimenti	Listino A	Listino B	Off.	Box
103977E	NERO	25,81 €	28,65 €	1	1

Elemento Lineare D. 100

Codice	Riferimenti	Listino A	Listino B	Off.	Box
103983	L. 0,25	0,00 €	0,00 €	1	1
103984	L. 0,50	Arrivo	Arrivo	1	1
103985	L. 1,00	Arrivo	Arrivo	1	1

ELEMENTO TELESCOPICO D. 100

Codice	Riferimenti	Listino A	Listino B	Off.	Box
103970	L. 0,25	0,00 €	0,00 €	1	1

Curva 45° D. 100 Nero

Codice	Riferimenti	Listino A	Listino B	Off.	Box
103986	NERO	Arrivo	Arrivo	1	1



Curva 90° D. 80 Nero 103976E



Codice	Riferimenti	Listino A	Listino B	Off.	Box
103976E	NERO	20,01 €	22,22 €	1	1

Manicotto Giunz. Ff 80 103982



Codice	Riferimenti	Listino A	Listino B	Off.	Box
103982	NERO	12,68 €	14,07 €	1	1

Elemento Flangiato Sof. 80 103967



Codice	Riferimenti	Listino A	Listino B	Off.	Box
103967	NERO	40,89 €	45,39 €	1	1

Raccordo A Y D. 80 Nero 103997



Codice	Riferimenti	Listino A	Listino B	Off.	Box
103997	NERO	141,18 €	156,71 €	1	1

Rosone Coprimuro Epdm D. 80 103978E



Codice	Riferimenti	Listino A	Listino B	Off.	Box
103978E	NERO	8,30 €	9,21 €	1	1

Collare A Muro D. 80 103979E



Codice	Riferimenti	Listino A	Listino B	Off.	Box
103979E	NERO	4,81 €	5,34 €	1	1

Raccordo A T D. 80 Nero Mmf 103974E



Codice	Riferimenti	Listino A	Listino B	Off.	Box
103974E	MMF	38,33 €	42,55 €	1	1
103975E	MFF	26,39 €	29,29 €	1	1

Cappello Terminale D.80 103980E



Codice	Riferimenti	Listino A	Listino B	Off.	Box
103980E	NERO	35,52 €	39,43 €	1	1

Griglia Scarico Fumo D. 80 103995



Codice	Riferimenti	Listino A	Listino B	Off.	Box
103995	NERO	9,64 €	10,70 €	1	1

Curva 90° D. 100 Nero



Codice	Riferimenti	Listino A	Listino B	Off.	Box
103987		Arrivo	Arrivo	1	1

Manicotto Giunz. Ff 100



Codice	Riferimenti	Listino A	Listino B	Off.	Box
103993	NERO	Arrivo	Arrivo	1	1

Elemento Flangiato Sof. 100



Codice	Riferimenti	Listino A	Listino B	Off.	Box
103968	NERO	Arrivo	Arrivo	1	1

Raccordo A Y D. 100



Codice	Riferimenti	Listino A	Listino B	Off.	Box
103998	NERO	Arrivo	Arrivo	1	1

Rosone Coprimuro Epdm D. 80 103990



Codice	Riferimenti	Listino A	Listino B	Off.	Box
103990	NERO	7,67 €	8,51 €	1	1

Collare A Muro D. 100 103991



Codice	Riferimenti	Listino A	Listino B	Off.	Box
103991	NERO	4,86 €	5,39 €	1	1

Raccordo A T D. 100 Nero



Codice	Riferimenti	Listino A	Listino B	Off.	Box
103989	MMF	Arrivo	Arrivo	1	1

Cappello Terminale D. 100 103992



Codice	Riferimenti	Listino A	Listino B	Off.	Box
103992	NERO	46,00 €	51,06 €	1	1

Griglia Scarico Fumo D. 100 103996



Codice	Riferimenti	Listino A	Listino B	Off.	Box
103996	NERO	34,51 €	38,31 €	1	1



Tubo Lineare in Acciaio Monoparete



Fascetta Di Bloccaggio Inox D. 80 Pz. 1 FB080



Guarnizione Siliconica D. 80 Pz. 1 GS0800

Codice	Cm.	Listino A	Listino B	Codice	Cm.	Listino A	Listino B	Codice	Cm.	Listino A	Listino B
MLA25080	0,25	8,67 €	9,62 €	FB080	80	3,55 €	3,94 €	GS0800	80	2,22 €	2,46 €
MLA500080	0,50	11,21 €	12,45 €	FB100	100	3,88 €	4,31 €	GS0100	100	2,77 €	3,08 €
MLA100080	1,00	23,46 €	26,04 €	FB120	120	4,11 €	4,56 €	GS0120	120	3,33 €	3,69 €
MLA250100	0,25	9,68 €	10,74 €	FB150	150	4,56 €	5,06 €	GS0150	150	4,44 €	4,92 €
MLA500100	0,50	16,33 €	18,13 €	FB180	180	4,99 €	5,54 €	GS0180	180	4,99 €	5,54 €
MLA100100	1,00	26,16 €	29,03 €	FB200	200	5,44 €	6,04 €	GS0200	200	5,57 €	6,18 €
MLA250120	0,25	10,56 €	11,72 €	<p>Supporto Per Solaio E/O Muro D. 80 SPS080</p>				<p>Raccordo A T 135° Inox D. 180 RT135180</p>			
MLA500120	0,50	19,13 €	21,23 €								
MLA100120	1,00	25,33 €	28,11 €								
MLA250150	0,25	12,39 €	13,75 €								
MLA500150	0,50	23,66 €	26,27 €	<p>Supporto Per Solaio E/O Muro D. 180 SPS180</p>				<p>Raccordo A T 90° Inox D. 180 RT90180</p>			
MLA100150	1,00	36,67 €	40,70 €								
MLA250180	0,25	15,22 €	16,90 €								
MLA500180	0,50	27,90 €	30,97 €								
MLA100180	1,00	43,67 €	48,48 €								
MLA250200	0,25	16,00 €	17,76 €								
MLA500200	0,50	28,90 €	32,08 €								
MLA100200	1,00	46,34 €	51,44 €								



Curva 45° O Inox D. 180 C45180



Curva 90° O Inox D. 180 C90180



Raccordo A T 90° Inox D. 180 RT90180

Codice	Cm.	Listino A	Listino B	Codice	Cm.	Listino A	Listino B	Codice	Cm.	Listino A	Listino B
C45080	80	19,68 €	21,85 €	C90080	80	26,11 €	28,98 €	RT90080	80	40,28 €	44,71 €
C45100	100	20,99 €	23,30 €	C90100	100	27,12 €	30,11 €	RT90100	100	42,08 €	46,71 €
C45120	120	17,69 €	19,64 €	C90120	120	29,02 €	32,21 €	RT90120	120	34,66 €	38,48 €
C45150	150	19,90 €	22,09 €	C90150	150	25,75 €	28,58 €	RT90150	150	39,23 €	43,54 €
C45180	180	21,54 €	23,91 €	C90180	180	43,97 €	48,81 €	RT90180	180	65,51 €	72,71 €
C45200	200	30,57 €	33,93 €	C90200	200	54,35 €	60,33 €	RT90200	200	72,97 €	81,00 €



Tappo Con Scarico E/O Cieco Inox D. 180 TCS180



Supporto Per Solaio E/O Muro D. 180 SPS180



Raccordo A T 135° Inox D. 180 RT135180

Codice	Cm.	Listino A	Listino B	Codice	Cm.	Listino A	Listino B	Codice	Cm.	Listino A	Listino B
TCS080	80	29,79 €	33,06 €	SPS080	80	35,69 €	39,61 €	RT135080	80	71,07 €	78,89 €
TCS100	100	31,68 €	35,16 €	SPS100	100	66,95 €	74,31 €	RT135100	100	71,07 €	78,89 €
TCS130	120	33,57 €	37,26 €	SPS120	120	75,32 €	83,61 €	RT135120	120	60,13 €	66,74 €
TCS150	150	38,13 €	42,32 €	SPS150	150	47,39 €	52,60 €	RT135150	150	74,35 €	82,53 €
TCS180	180	41,00 €	45,51 €	SPS180	180	100,42 €	111,47 €	RT135180	180	102,88 €	114,19 €
TCS200	200	32,32 €	35,87 €	SPS200	200	100,95 €	112,06 €	RT135200	200	107,56 €	119,39 €



Cappello A Botte Acciaio Antivento D. 180 CB180



Terminale Eolico Innesto Maschio D. 180 CR180



Cappello Parapioggia Inox D. 180 CPP180

Codice	Cm.	Listino A	Listino B	Codice	Cm.	Listino A	Listino B	Codice	Cm.	Listino A	Listino B
CB080	80	35,02 €	38,87 €	CR080	80	Arrivo	Arrivo	CPP080	80	19,53 €	21,68 €
CB100	100	80,56 €	89,42 €	CR100	100	122,97 €	136,49 €	CPP100	100	21,66 €	24,04 €
CB120	120	85,14 €	94,51 €	CR125	120	122,97 €	136,49 €	CPP120	120	20,17 €	22,39 €
CB150	150	50,17 €	55,69 €	CR150	150	126,43 €	140,34 €	CPP150	150	23,58 €	26,18 €
CB180	180	107,56 €	119,39 €	CR180	180	143,39 €	159,16 €	CPP180	180	27,52 €	30,54 €
CB200	200	110,47 €	122,62 €	CR200	200	151,53 €	168,20 €	CPP200	200	29,94 €	33,24 €



XD10KTR Three Phase Hybrid Inverter
 Categoria: Inverter
 Tag: Inverter Trifase ibrido, INVT Incluso Wifi F011600-000730 accessorio

Codice	Riferimenti	Listino A	Listino B	Off.	Box
XD10KTR	10 Kw	2143,82 €	2143,82 €	1	1
F011600	WIFI	55,19 €	55,19 €	1	1



INVT XD6KTL Single Phase Hybrid Inverter
 COD: XD6KTL
 Categoria: Inverter
 Tag: Inverter monofase ibrido, INVT Incluso Wifi F011600-000730

Codice	Riferimenti	Listino A	Listino B	Off.	Box
XD6KTL-RL1	6 Kw	1670,07 €	1853,78 €	1	1
F011600	WIFI	55,19 €	55,19 €	1	1

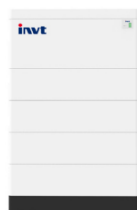

Batteria ad alta tensione GRP2.56-SHV La batteria ad alta tensione GRP2.56-SHV presenta un design modulare ed è compatibile con l'inverter ibrido XD5-12KTR e funziona in un'ampia gamma di temperature. Dotata di celle LFP per la massima sicurezza e ciclo di vita.

Codice	Riferimenti	Listino A	Listino B	Off.	Box
GRP2.56SHV	2,56 Kw	875,95 €	875,95 €	1	1



Batteria a bassa tensione GRP5.12-WLV La batteria a bassa tensione GRP5.12-WLV è compatibile con l'inverter ibrido XD3-6KTL per sistemi solari residenziali. Adottando un design plug-and-play per una facile installazione, è dotata di celle LFP per la massima sicurezza e ciclo di vita.

Codice	Riferimenti	Listino A	Listino B	Off.	Box
GRPS12-WLV	5 Kw	1733,53 €	1924,22 €	1	1



HV BOX INSEMENTO BATTERIE FINO A 20 KW

Codice	Riferimenti	Listino A	Listino B	Off.	Box
HVBOX	Fino a 20 kw	1071,14 €	1071,14 €	1	1



PA40X240 Profilo in alluminio per viti esagonali 240cm 40x40

PA40X480 Profilo in alluminio per viti esagonali 480cm 40x40

Codice	Riferimenti	Listino A	Listino B	Off.	Box
PA40X240		Arrivo	Arrivo	1	1
PA40X480		Arrivo	Arrivo	1	1



MT30 Morsetto terminale 30 mm con vite e inserto

0

Codice	Riferimenti	Listino A	Listino B	Off.	Box
MT30	30 mm	Arrivo	Arrivo	1	1
		Arrivo	Arrivo	1	1



MCMC50 Morsetto centrale - Montaggio a scatto con scanalatura e vite

0

Codice	Riferimenti	Listino A	Listino B	Off.	Box
MCMC50		Arrivo	Arrivo	1	1
		Arrivo	Arrivo	1	1



BMM10X30 Bullone a martello tipo 28/15 - M10x30

0

Codice	Riferimenti	Listino A	Listino B	Off.	Box
BMM10X30		Arrivo	Arrivo	1	1

GT145TR Gancio per tetto Vario 145 mm (4-5-5-5) con tripla regolazione Acciaio



0

Codice	Riferimenti	Listino A	Listino B	Off.	Box
GT145TR	145 mm	Arrivo	Arrivo	1	1
		Arrivo	Arrivo	1	1



PT40X40 Ponte trapezoidale 40cm H-40 in EPDM per coperture in lamiera grecata

0

Codice	Riferimenti	Listino A	Listino B	Off.	Box
PT40X40		Arrivo	Arrivo	1	1
		Arrivo	Arrivo	1	1



CP10CM Connettore di profilo 10cm

0

Codice	Riferimenti	Listino A	Listino B	Off.	Box
CP10CM	Cm. 10	Arrivo	Arrivo	1	1
		Arrivo	Arrivo	1	1



VDM10X250 Vite a doppia filettatura M10x250 e adattatore

VDM10X300 Vite a doppia filettatura M10x300 e adattatore

Codice	Riferimenti	Listino A	Listino B	Off.	Box
VDM10X250		Arrivo	Arrivo	1	1
VDM10X300		Arrivo	Arrivo	1	1



NNA1M Guarnizione autoadesiva in gomma EPDM 1m

0

Codice	Riferimenti	Listino A	Listino B	Off.	Box
NNA1M		Arrivo	Arrivo	1	1



Scheda Tecnica



SIME NATURAL 300/5.44 S 8500269

Codice	Pannello	Modello	Riferimenti	Listino A	Listino B
8500269	Sime Natural 300/5.44 S 2 P	tetti falda/piani	300 Litri	2929,35 €	3251,57 €

Incentivi

Modello	Superficie Lorda	Coefficiente val.	Energia prodotta	Incentivo annuo	Durata incentivo	Incentivo complessivo
Sime Natural 300/5.44 S	M2	€/KW	KW/H	€	Anni	€
	5,2	0,35	439	800	2	2055



KIT SOLARE



Codice	Pannello	Modello	Riferimenti	Listino A	Listino B
8500180	Easy System 1-2 I 1 P	Incasso	200 Litri	Arrivo	Arrivo
8500181	Easy System 3-4 I 2 P	Incasso	300 Litri	Arrivo	Arrivo
8500183	Easy System 1-2 FA 1 P	tetti a falda	200 Litri	Arrivo	Arrivo
8500353	Easy System 3-4 FA 2 P	tetti a falda	300 Litri	4513,92 €	5010,46 €
8500185	Easy System 5-6 FA 2 P	tetti a falda	400 Litri	Arrivo	Arrivo
8500186	Easy System 1-2 PR 1 P	tetti piani	200 Litri	Arrivo	Arrivo
8500356	Easy System 3-4 PR 2 P	tetti piani	300 Litri	4269,93 €	4739,62 €
8500188	Easy System 5-6 PR 2 P	tetti piani	400 Litri	Arrivo	Arrivo

PANNELLI GRUPPO TP COMPOSTO DA:

- 1) Art. 8500073 SIME PLANO 272
- 2) Collettore solare piano struttura in allum. navale arricchito al magnesio Pz. 2
- 3) 8500301 KIT Connessione dei due Collettore solare SIMESOL 1
- 4) 8500005 Telaio di fissaggio
- 5) 8106952 "KIT GI 1CP composto da:
 - A) GR. IDR. SOLARE 1C TERMOSOLIS
 - B) KIT STAFFA SUPP. VASO ESP. SOL.
 - C) ASS. TUBO CORRUG. COLL. VASO ESP."



SUPERFICIE INCLINATA

SUPERFICIE PIANA

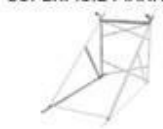

Codice	Pannello	Modello	Riferimenti	Listino A	Listino B
8500073TP	Kit 2 Pannelli	2 P	Tetto Piano	2844,85 €	3157,78 €
8500073TF	Kit 2 Pannelli	2 P	Tetto Inclinato	2887,72 €	3205,37 €



Scheda Tecnica



Installabile a muro nella versione 110 lt. e a basamento nelle versioni 200 e 300 litri. Serbatoio in acciaio con vetrificazione a doppio strato. Anodo di magnesio anticorrosione sostituibile. Serpentino di riscaldamento avvolto esternamente al bollitore. Funzione anti-legionella automatica. Elevata silenziosità. Serpentino interno per collegamento ad impianto solare termico (versione 300 S). Contatto per integrazione con impianto fotovoltaico. Resistenza elettrica integrata per assicurare Comfort anche nelle condizioni più estreme. Il prodotto raggiunge i requisiti necessari ai fini della detrazione fiscale del 65% e 110%

Codice	Riferimenti	Listino A	Listino B	Off.	Box
8115842	Lt 110	1775,39 €	1970,68 €	1	1
8115843	Lt 200	2539,79 €	2819,17 €	1	1
8115846	Lt 200 S	2704,49 €	3001,98 €	1	1
8115845	Lt 300 S	3032,96 €	3366,58 €	1	1

Codice	Eco contributo GSE	Contributo GSE
8500269	Eco contributo GSE	2.055,00 €
8115842	Eco contributo GSE	400,00 €
8115843	Eco contributo GSE	400,00 €
8115845	Eco contributo GSE	700,00 €
Easyv System 1-2I/1-2 FA/1-2PR	Eco contributo GSE	698,00 €
Easyv System 3-4TP/3-4 FA	Eco contributo GSE	2.055,00 €
Easyv System 5-6I/5-6 FA/1-6PR	Eco contributo GSE	1.397,00 €





Kit Integrazione Solare Cal.
KSCM12

Codice	Riferimenti	Listino A	Listino B	Off.	Box
KSCM12	D. 1/2"	348,83 €	387,20 €	1	1
KSCM34	D. 3/4"	383,40 €	425,58 €	1	1

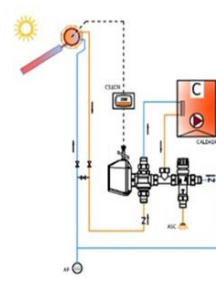

Centralina Solare Incasso Pannelli
Circ. Naturale CS1CN



Codice	Riferimenti	Listino A	Listino B	Off.	Box
CS1CN	Incasso	95,64 €	106,16 €	1	1
CS3CN	Esterno	104,75 €	116,27 €	1	1



Centralina Solare Incasso Pannelli
Circ. Forzata CS2CF



Codice	Riferimenti	Listino A	Listino B	Off.	Box
CS2CF	Incasso	127,52 €	141,55 €	1	1
CS4CF	Esterno	136,63 €	151,66 €	1	1



Gruppo di circolazione di ritorno per
circuiti primari di impianti solari, d.
3/4" 93S002AE05G

Codice	Riferimenti	Listino A	Listino B	Off.	Box
93S002AE05G	D. 3/4"	378,32 €	419,93 €	1	1

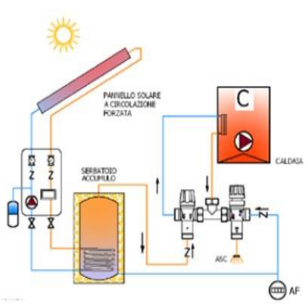

S142 Doppia Valvola Ritegno
93S142AE05



Codice	Riferimenti	Listino A	Listino B	Off.	Box
93S142AE05	D. 3/4"	12,27 €	13,62 €	1	1

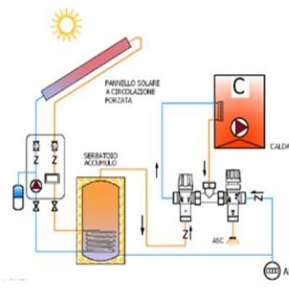

Kit Solare Miscelatore 1/2" KSCT12



Codice	Riferimenti	Listino A	Listino B	Off.	Box
KSCT12	D. 1/2"	218,45 €	242,47 €	1	1



Miscelatore Termostatico 3/4"
Acqua Sanitaria MTS34

Codice	Riferimenti	Listino A	Listino B	Off.	Box
MTS34	D. 3/4"	82,95 €	92,08 €	1	1
MTS10	D. 1"	89,69 €	99,56 €	1	1



Miscelatore termostatico solare
attacchi maschio 1" via laterale
93S112AE05

Codice	Riferimenti	Listino A	Listino B	Off.	Box
93S112AE05	D. 1"	65,79 €	73,02 €	1	1
93S103AF05	D. 1 1/4"	92,73 €	102,93 €	1	1

Valvola Deviatrice Da 3/4" VDT34

PER UTILIZZO CON ACQUA SANITARIA
Quando l'acqua proveniente dalla via centrale arriva a 45° C, la valvola devia l'acqua da un'uscita laterale all'altra

Pressione massima di esercizio: 10 bar
Pressione di lavoro: 1 ÷ 5 bar
Temperatura massima acqua calda: 100° C

Codice	Riferimenti	Listino A	Listino B	Off.	Box
VDT34	D. 3/4"	100,95 €	112,06 €	1	1
VDT10	D. 1"	104,24 €	115,71 €	1	1

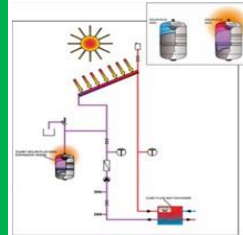

Vaso d'espansione
art. S130 Apr. S130
Vaso d'espansione
per impianti solari.
Temp. max 140°C.



Codice	Riferimenti	Listino A	Listino B	Off.	Box
93S130AE12	12 lt	39,74 €	44,12 €	1	1
93S130AE18	18 lt	54,37 €	60,35 €	1	1
93S130AE24	24 lt	51,49 €	57,16 €	1	1



Doppia valvola di ritegno art. S142
Apr. S142 Doppia valvola di ritegno. Consente la sostituzione del vaso d'espansione senza lo svuotamento dell'impianto.

Codice	Riferimenti	Listino A	Listino B	Off.	Box
93S142AE05	D. 3/4"	12,27 €	13,62 €	1	1



Raccordo girevole diritto giallo per connessione defangatore compatto/caldaia.
Comprensivo di due guarnizioni piane di tenuta. CDGFFG

Codice	Riferimenti	Listino A	Listino B	Off.	Box
CDGFFG	D. 1/2" icma	12,95 €	14,37 €	1	1



Bocchettone Sede Piana 1"X1/2"
82789AD05

Codice	Riferimenti	Listino A	Listino B	Off.	Box
82789AD05	1"X1/2"	3,12 €	3,46 €	1	5
82789AE05	1 1/2"X3/4"	7,79 €	8,65 €	1	5



88P3280153 d. 1"1/2
Circolatore elettronico Grundfos UPM3 HYBRID 25-70 interasse 130 mm. Pressione variabile, pressione costante, curve costanti, AUTO ADAPT, segnale PWM. CAVO DI POTENZA INCLUSO

88P3260153 d. 1"1/2
Circolatore elettronico Grundfos UMP3 PWM 25-70, interasse 130 mm. Con segnale PWM



Codice	Riferimenti	Listino A	Listino B	Off.	Box
88P3280153	25-70	167,69 €	186,14 €	1	5
88P3260153	25-70	164,46 €	182,55 €	1	5



88P3200153 d. 11/4"
P320 Circolatore Ups 25-40
88P3200153

88P3210153 d. 11/4"
P321 Circolatore Ups 25-60
88P3210153

Codice	Riferimenti	Listino A	Listino B	Off.	Box
88P3200153	d. 11/4"	108,37 €	120,29 €	1	5
88P3210153	d. 11/4"	104,75 €	116,27 €	1	5



Circolatore CALDAIA Wilo C. 130 RSL15/5-3



Codice	Riferimenti	Listino A	Listino B	Off.	Box
4505415	d. 1"	105,95 €	117,60 €	1	5



Staffa per vaso di espansione solare riscaldamento sanitario filet.1"
MTSS1

Codice	Riferimenti	Listino A	Listino B	Off.	Box
MTSS1	D.1	34,16 €	37,92 €	1	1



Valvola Sfiato Aria Per Impianti Solari Icma 93S110AD05

Codice	Riferimenti	Listino A	Listino B	Off.	Box
93S110AD05		10,48 €	11,64 €	1	1



Bocchettone Sede Piana 1 1/2"X1"
82789AF05

Codice	Riferimenti	Listino A	Listino B	Off.	Box
82789AF05	1 1/2"X1"	8,66 €	9,62 €	1	5



Circolatori elettronici per solare basso consumo energetico

Codice	Riferimenti	Listino A	Listino B	Off.	Box
NCEEL1560130A	D. 1"	Arrivo	Arrivo	1	5
NCEEL2560130A	D. 1"1/2"	Arrivo	Arrivo	1	5

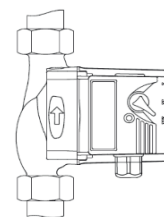

Circolatore

Codice	Riferimenti	Listino A	Listino B	Off.	Box
25-80/180		172,06 €	190,99 €	1	5
25-40/180		105,01 €	116,56 €	1	5
25-40/130		105,01 €	116,56 €	1	5
32-40/180		112,60 €	124,99 €	1	5
25-60/130		108,80 €	120,77 €	1	5
25-60/180		108,80 €	120,77 €	1	5
32-60/180		117,66 €	130,60 €	1	5
25-70/180		136,64 €	151,67 €	1	5
25-70/130		136,64 €	151,67 €	1	5

Corpo valvola
2 vie passaggio totale

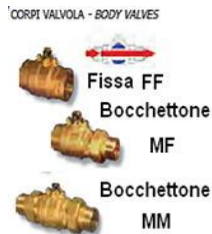

Codice	Riferimenti	Listino A	Listino B	Off.	Box
632F	1½" FF	26,97 €	29,94 €	1	1
602F	¾" FF	30,08 €	33,39 €	1	1
612F	1" FF	38,84 €	43,11 €	1	1
622F	1½" FF	46,18 €	51,26 €	1	1
632FB	1½" MF	29,58 €	32,83 €	1	1
602FB	¾" MF	33,85 €	37,58 €	1	1
612FB	1" MF	44,78 €	49,71 €	1	1
622FB	1½" MF	54,88 €	60,92 €	1	1
632B	1½" MM	32,21 €	35,75 €	1	1
602B	¾" MM	33,68 €	37,38 €	1	1
612B	1" MM	50,73 €	56,31 €	1	1
622B	1½" MM	63,58 €	70,58 €	1	1

Corpo valvola
3 vie passaggio totale
Deviatrice

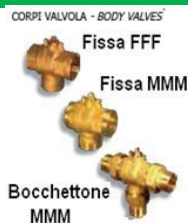

Codice	Riferimenti	Listino A	Listino B	Off.	Box
633F	1½" FFF	40,05 €	44,45 €	1	1
603F	¾" FFF	44,25 €	49,12 €	1	1
613F	1" FFF	51,14 €	56,77 €	1	1
623F	1½" FFF	67,62 €	75,06 €	1	1
603M	¾" MMM	40,05 €	44,45 €	1	1
613M	1" MMM	40,05 €	44,45 €	1	1
623M	1½" MMM	51,14 €	56,77 €	1	1
643M	1½" MMM	67,62 €	75,06 €	1	1
633B	1½" MMM	47,97 €	53,25 €	1	1
603B	¾" MMM	49,84 €	55,33 €	1	1
613B	1" MMM	67,31 €	74,71 €	1	1
623B	1½" MMM	93,93 €	104,26 €	1	1

Corpo valvola
3 vie passaggio totale
Miscelatrice

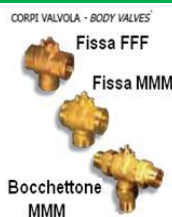

Codice	Riferimenti	Listino A	Listino B	Off.	Box
633T	1½" FFF	40,05 €	44,45 €	1	1
603T	¾" FFF	42,91 €	47,63 €	1	1
613T	1" FFF	51,14 €	56,77 €	1	1
623T	1½" FFF	67,62 €	75,06 €	1	1
603V	¾" MMM	40,05 €	44,45 €	1	1
613V	1" MMM	40,05 €	44,45 €	1	1
623V	1½" MMM	51,14 €	56,77 €	1	1
643V	1½" MMM	67,62 €	75,06 €	1	1
633U	1½" MMM	47,97 €	53,25 €	1	1
603U	¾" MMM	56,78 €	63,02 €	1	1
613U	1" MMM	72,19 €	80,13 €	1	1
623U	1½" MMM	93,93 €	104,26 €	1	1

Servomotori Abbinabili
Corpo valvole 2 vie da 1½" a 1½"



Codice	Riferimenti	Listino A	Listino B	Off.	Box
3 Fili 230 w 60" S/without Auxiliary Microswitch comando 1 termostato 1 servomotore					
M6A2	3 Fili 230 v	86,00 €	95,46 €	1	1
3 Fili 230 w 60" con without Auxiliary Microswitch comando 1 termostato 1 servomotore					
M6B2	3 Fili 230 v	88,66 €	98,41 €	1	1
2 Fili 230 w 60" S/without Auxiliary Microswitch comando 1 termostato + servomotori					
R6A2	2 Fili 230 v	102,70 €	114,00 €	1	1
2 Fili 230 w 60" con without Auxiliary Microswitch comando 1 termostato + servomotori					
R6B2	2 Fili 230 v	104,07 €	115,51 €	1	1

Servomotori

Abbinabili Corpo valvole 3 vie da 1½" a 1½" Chiusura Angolo



Codice	Riferimenti	Listino A	Listino B	Off.	Box
3 Fili 230 w 60" S/without Auxiliary Microswitch comando 1 termostato 1 servomotore					
M6A3	3 Fili 230 v	79,99 €	88,78 €	1	1
3 Fili 230 w 60" con without Auxiliary Microswitch comando 1 termostato 1 servomotore					
M6B3	3 Fili 230 v	86,03 €	95,49 €	1	1
2 Fili 230 w 60" S/without Auxiliary Microswitch comando 1 termostato + servomotori					
R6A3	2 Fili 230 v	91,71 €	101,80 €	1	1
2 Fili 230 w 60" con without Auxiliary Microswitch comando 1 termostato + servomotori					
R6B3	2 Fili 230 v	96,79 €	107,43 €	1	1

Servomotori Abbinabili
Corpo valvole 3 vie da 1½" a 1½" Miscelatrice



Codice	Riferimenti	Listino A	Listino B	Off.	Box
3 Fili 230 w 60" S/ without Auxiliary Microswitch comando 1 termostato 1 servomotore					
P6A2	3 Fili 230 v	90,55 €	100,51 €	1	1
3 Fili 230 w 60" con without Auxiliary Microswitch comando 1 termostato 1 servomotore					
P6B2	3 Fili 230 v	95,52 €	106,02 €	1	1
2 Fili 230 w 60" S/ without Auxiliary Microswitch comando 1 termostato + servomotore					
T6A2	2 Fili 230 v	102,28 €	113,53 €	1	1
2 Fili 230 w 60" con without Auxiliary Microswitch comando 1 termostato + servomotori					
T6B2	2 Fili 230 v	107,25 €	119,04 €	1	1

Cos'è un impianto di riscaldamento a pavimento?



L'impianto radiante a pavimento è un sistema che permette il riscaldamento degli ambienti tramite l'irraggiamento della superficie.

Gli elementi radianti, costituiti da tubi in materiale resistente alle alte temperature ed al calpestio, vengono inseriti sotto il pavimento, nella parete o nel soffitto, a seconda delle esigenze specifiche.

L'impianto risulta così invisibile, a tutto vantaggio dell'estetica e consentendo un miglior sfruttamento degli spazi.

La trasmissione del calore avviene principalmente per irraggiamento e non per convezione (come nel caso dei termosifoni). In questo modo si evitano fastidiosi spostamenti d'aria e di polveri e il calore viene diffuso in modo più uniforme. Contattaci ora per un preventivo o per maggiori informazioni

Quanto costa un impianto di riscaldamento a pavimento?

Il prezzo da sostenere per l'acquisto del materiale dipende da alcuni fattori, soprattutto riconducibili alla tipologia e alla qualità della struttura.

In generale, più è alta la dispersione dell'edificio e maggiore sarà la spesa per il materiale da installare (tubo e spessore isolante). Quindi un buon isolamento dell'edificio garantisce sia un risparmio nella gestione del riscaldamento che un risparmio nell'acquisto dell'impianto.

Richiede un preventivo gratuito ad un nostro tecnico. Alla vostra conferma vi saranno dati tutti i documenti e gli schemi per l'installazione del vostro impianto.



Riscaldamento e raffrescamento a pavimento

L'impianto radiante a pavimento per raffrescare

L'impianto radiante a pavimento, oltre ad essere un ottimo sistema di riscaldamento per l'inverno, è la soluzione anche per il raffrescamento estivo. Con un unico sistema, a basso consumo e invisibile, è possibile ottenere comfort e risparmio in tutte le stagioni. Scegli l'impianto radiante per la tua casa



Riscaldamento e raffrescamento a pavimento

Il sistema è costituito da un pannello isolante bugnato rivestito da un foglio rigido in PS nero resistente al calpestio che funge da barriera contro l'umidità.

Sul pannello viene posato il tubo multistrato PEX AL PEX con barriera antiossigeno in alluminio o il tubo PE-RT senza alluminio, entrambi molto maneggevoli durante la posa e nelle curve.

L'installazione del sistema è semplificata grazie alle bugne dell'isolante, che con il loro profilo pronunciato consentono un ottimo bloccaggio del tubo. Il tubo, inoltre, risulta sollevato dal pannello isolante, così da migliorare lo scambio termico.

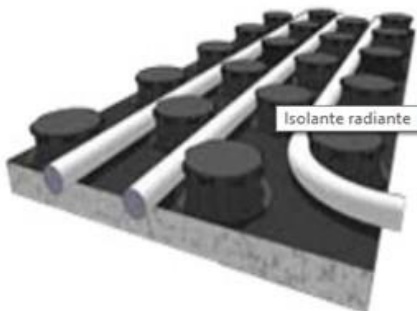
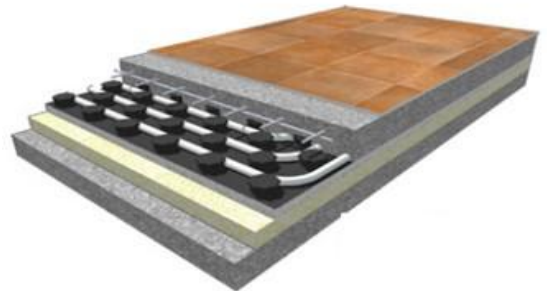

Pannello isolante per il massimo isolamento e resa

Un indice di qualità dei sistemi a pavimento radiante è dato dal tipo di accoppiamento tubazione - pannello isolante.

Lo strato di isolamento termico ha l'importante funzione di mantenere alta l'efficienza dell'impianto radiante riducendo le dispersioni termiche verso il basso.

Formato da uno strato isolante EPS, accoppiato ad un foglio rigido di PS di colore nero con funzione di barriera contro l'umidità. Lo strato di isolamento termico ha la funzione di mantenere alta l'efficienza dell'impianto radiante riducendo le dispersioni termiche verso il basso.



Additivo fluidificante per il confezionamento di impasti cementizi. Riduce l'uso d'acqua del 20-30%. Migliora la densità, la conducibilità termica, la lavorabilità del massetto. Dosaggio 1 L. per 100 kg di legante (cemento in polvere). Esente da cloruri.



il dosaggio è pari al 1,5% del contenuto d'acqua totale dei circuiti.

Liquido inibitore di corrosione con battericida da usare a riempimento impianto che evita l'adesione dei carbonati e protegge dall'ossidazione e dalla corrosione i comuni metalli. Contiene inoltre un efficace biocida in grado di ridurre notevolmente lo sviluppo di alghe e prodotti biologici all'interno dell'impianto. Il liquido art. P220 forma un film monomolecolare protettivo sulle pareti degli impianti termici e refrigeranti ed elimina le sollecitazioni termiche e gassose dovute all'accoppiamento di metalli diversi. Adatto per una buona manutenzione del circuito idraulico;

Codice	Riferimenti	Listino A	Listino B	Off.	Box
88P2061099	tanica da 10 L.	49,35 €	54,78 €	1	1

Codice	Riferimenti	Listino A	Listino B	Off.	Box
88P2200199	tanica da 1 L.	33,01 €	36,64 €	1	1



Comando elettrotermico con microinterruttore di fine corsa per segnale pulito normalmente chiuso. A fine corsa il microinterruttore interrompe il segnale in uscita. Conformi a normative CE.
 - Tensione d'alimentazione 24 o 230 volt;
 - Tempo di apertura 3 min. c.a;
 - Temperatura di funzionamento 5-50°C
 ART.982 | 979 Normalmente chiuso

CCollegamenti:
 Fili Marrone-Blu = Alimentazione



Comando elettrotermico con microinterruttore di fine corsa per segnale pulito normalmente chiuso. A fine corsa il microinterruttore interrompe il segnale in uscita. Conformi a normative CE.
 - Tensione d'alimentazione 24 o 230 volt;
 - Tempo di apertura 3 min. c.a;
 - Temperatura di funzionamento 5-50°C
 ART.983 | 980 Normalmente chiuso

Collegamenti:
 Fili Marrone-Blu = Alimentazione
 Fili Nero-Grigio = cointerruttore

Codice	Riferimenti	Listino A	Listino B	Off.	Box
82982NC54	28X1,5 - 24 volt	32,05 €	35,58 €	1	1
82982NC53	28X1,5 - 230 volt	32,05 €	35,58 €	1	1
82979NC54	30X1,5 - 24 volt	32,49 €	36,07 €	1	1
82979NC53	30X1,5 - 230 volt	32,49 €	36,07 €	1	1
FA979NC53	FAR - 230 volt	33,50 €	37,19 €	1	1

Codice	Riferimenti	Listino A	Listino B	Off.	Box
82983NC54	28X1,5 - 24 volt	30,38 €	33,73 €	1	1
82983NC53	28X1,5 - 230 volt	30,38 €	33,73 €	1	1
82980NC54	30X1,5 - 24 volt	30,83 €	34,22 €	1	1
82980NC53	30X1,5 - 230 volt	30,83 €	34,22 €	1	1
FA980NC53	FAR - 230 volt	30,83 €	34,22 €	1	1



Valvola fan coil 2 vie sede piana. Temperatura massima d'esercizio 110°C
 CONNESSIONE 30X1,5

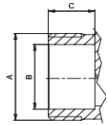

	A	B	C
G1/2"	G1/2"	13,8	11,5
G3/4"	G3/4"	19,5	13
G1"	G1"	24	13,5



Comando elettrotermico on-off normalmente aperto. Conformi a normative CE.
 - Tensione d'alimentazione 24 o 230 volt;
 - Tempo di apertura 3 min. c.a;
 - Temperatura di funzionamento 5-50°C. ART.983 | 980 Normalmente aperto

Collegamenti:
 Fili Marrone-Blu = Alimentazione

Codice	Riferimenti	Listino A	Listino B	Off.	Box
82371AD05	D. 1/2"	29,40 €	32,63 €	1	1
82371AE05	D. 3/4"	30,56 €	33,92 €	1	1
82371AF05	D. 1"	35,77 €	39,70 €	1	1

Codice	Riferimenti	Listino A	Listino B	Off.	Box
82983NA54	28X1,5 - 24 volt	36,52 €	40,54 €	1	1
82983NA53	28X1,5 - 230 volt	36,52 €	40,54 €	1	1
82980NA54	30X1,5 - 24 volt	36,52 €	40,54 €	1	1
82980NA53	30X1,5 - 230 volt	36,52 €	40,54 €	1	1



Cassetta per impianti di riscaldamento sottopavimento verniciata bianco RAL 9010 con serratura. È possibile regolare l'altezza della cassetta (da 630 a 930 mm) e la profondità (da 110 a 130 mm). È possibile regolare la posizione interna del collettore tanto in altezza quanto lateralmente. Per collettori senza pompa di circolazione. Lo spessore della lamiera, telaio e sportello di 1 mm garantisce solidità costruttiva.



Cassetta per impianti di riscaldamento sottopavimento verniciata bianco RAL 9010 con serratura. È possibile regolare l'altezza della cassetta (da 630 a 930 mm) e la profondità (da 90 a 110 mm). È possibile regolare la posizione interna del collettore tanto in altezza quanto lateralmente. Per collettori senza pompa di circolazione. Lo spessore della lamiera, telaio e sportello di 1 mm garantisce solidità costruttiva.

Codice	Riferimenti	Sp.	Isolante	Listino A	Listino B
87197OC09	600 mm	110<->130		111,21 €	123,45 €
87197OF09	700 mm	110<->130		113,48 €	125,97 €
87197OK09	850 mm	110<->130		137,31 €	152,42 €
87197OG09	1000 mm	110<->130		153,19 €	170,04 €
87197OH09	1200 mm	110<->130		170,22 €	188,95 €

Codice	Riferimenti	Sp.	Isolante	Listino A	Listino B
87196OE09	500 mm	90<->110		96,30 €	106,89 €
87196OF09	700 mm	90<->110		100,13 €	111,14 €
87196OK09	850 mm	90<->110		118,19 €	131,19 €
87196OG09	1000 mm	90<->110		145,55 €	161,56 €
87196OH09	1200 mm	90<->110		158,67 €	176,13 €

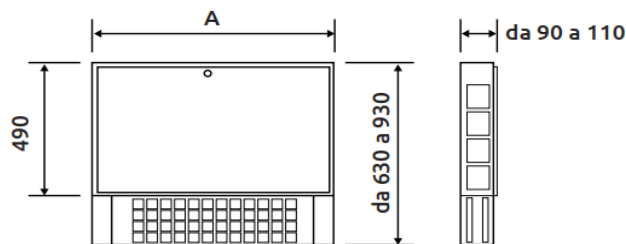
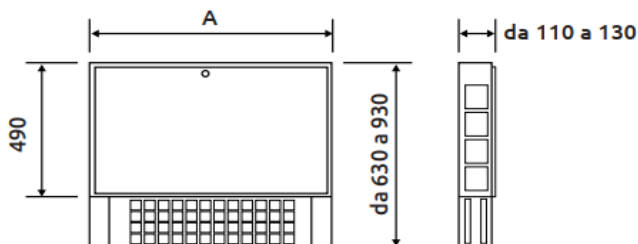



Pannello Isolante Termoformato in polistirene espanso sinterizzato preformato
 EPS, marchio CE - conforme alla norma EN 13163, completo di guscio laminato
 termoformato calpestabile spessore 600 micron con bugne in rilievo di 22mm.
 Adatto per l'alloggiamento di tubazioni diametro esterno 16mm e 17mm; passo di posa 50mm e multipli, completo di banda laterale di giunzione tra i pannelli per la stesura e la tenuta durante la gettata.

Codice	Riferimenti	Sp.	Isolante	Listino A	Listino B
88P1053099	1400x800	32 mm	10 mm	14,69 €	16,30 €
88P1054099	1400x800	42 mm	20 mm	15,35 €	17,04 €
88P1055099	1400x800	52 mm	30 mm	16,41 €	18,22 €
88P1056099	1400x800	62 mm	40 mm	19,36 €	21,49 €
88P1057099	1400x800	72 mm	50 mm	22,47 €	24,94 €



Pannello isolante Termoformato in polistirene espanso sinterizzato additivato grafite. Conduttività termica 0,030 W/mK, marchio CE - conforme alla norma EN 13163, completo di guscio laminato termoformato calpestabile spessore 600 micron con bugne in rilievo di 22mm. Adatto per l'alloggiamento di tubazioni diametro esterno 16mm e 17mm; passo di posa 50mm e multipli, completo di banda laterale di giunzione tra i pannelli per la stesura e la tenuta durante la gettata.

Codice	Riferimenti	Sp.	Isolante	Listino A	Listino B
88P105G3099	1400x800	32 mm	10 mm	15,38 €	17,07 €
88P105G4099	1400x800	40 mm	18 mm	15,50 €	17,20 €
88P105G5099	1400x800	55 mm	33 mm	18,50 €	20,53 €



Curva a 90° in poliammide per tubazioni diametri 16-17-18-20 mm; si posiziona, anche a tubazione installata, ideale per le curvature delle tubazioni in partenza dai collettori.

Codice	Riferimenti	Listino A	Listino B	Off.	Box
88P215BG99	16-18	2,17 €	2,41 €	1	1



CBinario in plastica antiurto con base autoadesiva totale di fissaggio, per l'alloggiamento delle tubazioni diametro 16-17mm e 20mm; passo di posa 50mm e multipli; lunghezza binario 2m. H = 24mm. Si applica nei sistemi piani.

Codice	Riferimenti	Listino A	Listino B	Off.	Box
88P2011799	16-18	3,15 €	3,49 €	1	1



Clip per fissaggio della tubazione nelle curve, da inserire su bugna - bugna in diagonale. Adatto per pannelli isolanti termoformati P105 e P106.

Codice	Riferimenti	Listino A	Listino B	Off.	Box
88P216OO99	16-17	0,26 €	0,29 €	1	1



Clips per il fissaggio manuale del tubo diametro 16-17-20 mm su pannelli isolanti piani.

Codice	Riferimenti	Listino A	Listino B	Off.	Box
88P202OO99	16-17-20 mm	0,15 €	0,16 €	1	1



Fascia isolante perimetrale adesiva in polietilene espanso a cellule chiuse, adatta per la posa dei pannelli radianti. La fascia perimetrale assorbe le dilatazioni termiche del pannello e la sua pellicola in polietilene evita le infiltrazioni dell'impasto cementizio nella parte inferiore del pannello. Disponibile in rotoli da 50m.

Codice	Riferimenti	Listino A	Listino B	Off.	Box
88P100OO99	h. 150 mm	1,35 €	1,50 €	1	1
88P1002599	h. 200 mm	2,27 €	2,52 €	1	1



Giunto di dilatazione in Polietilene espanso densità 50 kg/mc. Dotato di profilo ad H, con banda adesiva, colore rosso. Barra da 2 mt.

Codice	Riferimenti	Listino A	Listino B	Off.	Box
88P217OO99	2 mt	8,05 €	8,94 €	1	1



Collettore per impianti sottopavimento 1"

Codice	Riferimenti	Listino A	Listino B	Off.	Box
87K023PQ06	Usc. 5	243,48 €	270,26 €	1	1
87K023PK06	Usc. 6	275,36 €	305,65 €	1	1
87K023PR06	Usc. 7	291,83 €	323,93 €	1	1
87K023PL06	Usc. 8	316,07 €	350,84 €	1	1

SV4

30 / 50 / 80 / 100 / 150 litri

Volano Termico (o accumulo inerziale) per installazione sia sull'ANDATA che sul RITORNO dell'impianto, con funzione di accumulatore e separatore idraulico

+ Perché sceglierlo:

Se non sono già stati installati nell'impianto il separatore ed il collettore, il SV4 permette un importante risparmio sul costo di acquisto ed installazione del separatore, essendo già presente sul prodotto. SV4 conferisce regolarità di funzionamento alla pompa di calore, si installa facilmente nella parte interna al fabbricato, intercetta sia L'ANDATA che il RITORNO

DATI TECNICI

	SV4 30	SV4 50	SV4 80	SV4 100	SV4 150
Capacità (LT)	30	50	80	100	150
Massima temperatura di esercizio (C°)	90	90	90	90	90
Massima pressione di esercizio (bar)	6	6	6	6	6
Classe energetica	B	B	B	B	C
Peso netto (Kg)	12	17	21	30	47
Attacchi impianto	1 1/4	1 1/4	1 1/4	1 1/4	1 1/4
Attacco superiore (valvola sfiato)	1/2"	1/2"	1/2"	1/2"	1/2"
Attacco inferiore (defangatore)	1 1/4	1 1/4	1 1/4	1 1/4	1 1/4

DIMENSIONI

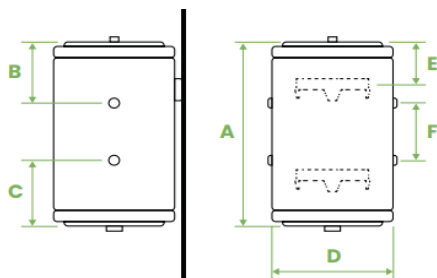

	A	B	C	D	E	F
SV4 30	440 mm	140 mm	140 mm	370 mm	113,5 mm	160 mm
SV4 50	600 mm	240 mm	185 mm	460 mm	180 mm	175 mm
SV4 80	780 mm	240 mm	255 mm	460 mm	180 mm	265 mm
SV4 100	960 mm	240 mm	360 mm	460 mm	180 mm	350 mm
SV4 150	935 mm	180 mm	240 mm	550 mm	180 mm	500 mm



Scaldabagno Bandini Braun Volano Termico
Sep 5 anni di garanzia

Scheda Tecnica



Codice	Riferimenti	Listino A	Listino B	Off.	Box
SV30C5VSEP	30 Lt.	366,88 €	407,23 €	1	1
SV50C5VSEP	50 Lt.	395,02 €	438,47 €	1	1
SV80C5VSEP	80 Lt.	418,26 €	464,26 €	1	1
SV100C5VSEP	100 Lt.	460,08 €	510,69 €	1	1

SV8

60 / 100 / 200 litri

Per installazione sia sulla mandata che sul ritorno del sistema con funzione di accumulo e separatore idraulico 4 connessioni aggiuntive per collegare una fonte di riscaldamento alternativa all'impianto di riscaldamento come fotovoltaico o sistema a pellet.

+ Perché sceglierlo:

Risparmio nell'acquisto di un separatore idraulico che è già incluso nel prodotto. Ottimizzazione del funzionamento dei cicli di riscaldamento della pompa di calore. 4 connessioni aggiuntive per collegare una fonte di riscaldamento alternativa all'impianto di riscaldamento come fotovoltaico o sistema a pellet.

DATI TECNICI

	SV8 60	SV8 100	SV8 200
Capacità (LT)	60	100	200
Temperatura massima d'esercizio (C°)	90	90	90
Pressione massima d'esercizio (bar)	6	6	6
Classe Energetica	C	B	C
Dimensioni collegamenti laterali	1"	1 1/4	1 1/4
Dimensioni collegamento superiore (top)	1/2"	1/2"	1/2"
Dimensioni collegamento inferiore (defangatore)	1 1/4	1 1/4	1 1/4

DIMENSIONI

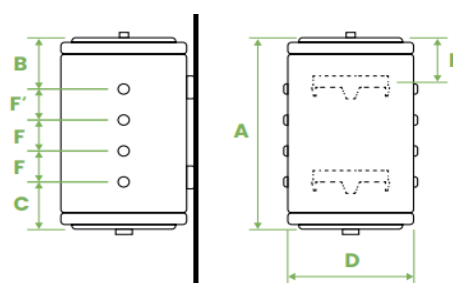

	A	B	C	D	E	F	F'
SV8 60	850 mm	137 mm	196 mm	370 mm	130 mm	175 mm	160 mm
SV8 100	950 mm	175 mm	175 mm	460 mm	172 mm	200 mm	200 mm
SV8 200	1105 mm	210 mm	295 mm	550 mm	180 mm	200 mm	200 mm



Scaldabagno Bandini Braun Volano Termico
Sep 5 anni di garanzia

Codice	Riferimenti	Listino A	Listino B	Off.	Box
SV0200C5V8	200 Lt.	836,56 €	928,58 €	1	1



Codice	Capacità	Listino A	Listino B
BST-200	200 lt.	1254,99 €	1393,04 €
BST-300	300 lt.	1498,89 €	1663,77 €
BST-400	400 lt.	1812,60 €	2011,99 €
BST-500	500 lt.	1940,41 €	2153,85 €
BST-800	800 lt.	Arrivo	Arrivo
BST-1000	1000 lt.	Arrivo	Arrivo

Bollitore verticale a doppio serpentino per solare



MODELLO	CODICE	ETICHETTA ENERGETICA CLASSE	SCAMBIATORE							
			Cap. litri	INF. m ²	SUP. m ²	Diam. mm	H mm			
BST-200	A3E0L47 PGP40	C	195	0,70	5	0,50	4	600	1170	
BST-300	A3E0L51 PGP40	C	290	1,20	8	0,75	5	650	1395	
BST-400	A3E0L53 PGP40	C	413	1,40	9	0,90	6	750	1445	
BST-500	A3E0L55 PGP40	C	495	1,80	12	0,90	6	750	1695	
BST-800	A3E0L60 VG470	C	785	2,00	13	1,20	8	1020	1870	
BST-1000	A3E0L62 VG470	C	916	2,40	15	1,20	8	1020	2120	
BST-800 + FL	A3E1L60 VG470	C	785	2,00	13	1,20	8	1020	1870	
BST-1000 + FL	A3E1L62 VG470	C	916	2,40	15	1,20	8	1020	2120	
BST-1500 + FL	A3E1H67 VW4A5	C	1641	3,60	36	1,80	16	1270	2530	
BST-2000 + FL	A3E1H70 VW4A5	C	1958	4,30	43	2,10	21	1370	2510	

Codice	Capacità	Listino A	Listino B
BSH-100	100 lt.	566,34 €	628,64 €
BSH-150	150 lt.	661,88 €	734,69 €
BSH-200	200 lt.	732,43 €	813,00 €
BSH-300	300 lt.	935,01 €	1037,86 €

Bollitore orizzontale a serpentino fisso

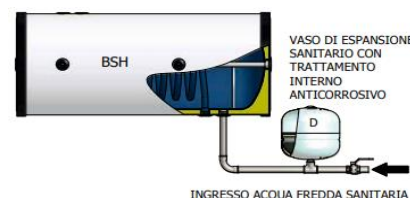

MODELLO	CODICE	ETICHETTA ENERGETICA CLASSE	Cap. litri	SCAMBIATORE								
				m ²	litri	Diam. mm	L mm	A mm	B mm	C mm	D mm	E mm
BSH-100	A3B0L38 PGP30	C	96	0,40	3	460	885	175	265	625	715	495
BSH-150	A3B0L43 PGP30	C	153	0,60	4	560	935	230	310	630	630	595
BSH-200	A3B0L47 PGP30	C	195	0,80	5	560	1155	230	310	850	850	595
BSH-300	A3B0L51 PGP30	C	290	1,05	7	610	1400	260	360	1040	1140	645

Codice	Capacità	Listino A	Listino B
BSV-150	150 lt.	Arrivo	Arrivo
BSV-200	200 lt.	1115,45 €	1238,15 €
BSV-300	300 lt.	1301,36 €	1444,51 €
BSV-400	400 lt.	1615,08 €	1792,74 €
BSV-500	500 lt.	1696,41 €	1883,01 €
BSV-800	800 lt.	Arrivo	Arrivo
BSV-1000	1000 lt.	Arrivo	Arrivo

Bollitore verticale a serpentino fisso



MODELLO	CODICE	ETICHETTA ENERGETICA CLASSE	SCAMBIATORE				
			Cap. litri	m ²	litri	Diam. mm	H mm
BSV-150	A3A0L43 PGP40	C	153	0,60	4	600	950
BSV-200	A3A0L47 PGP40	C	195	0,70	5	600	1170
BSV-300	A3A0L51 PGP40	C	290	1,05	7	650	1395
BSV-400	A3A0L53 PGP40	C	413	1,20	8	750	1445
BSV-500	A3A0L55 PGP40	C	495	1,45	9	750	1695
BSV-800	A3A0L60 VG470	C	785	2,00	13	1020	1870
BSV-1000	A3A0L62 VG470	C	916	2,40	15	1020	2120
BSV-800 + FL	A3A1L60 VG470	C	785	2,00	13	1020	1870
BSV-1000 + FL	A3A1L62 VG470	C	916	2,40	15	1020	2120
BSV-1500 + FL	A3A1H67 VW4A5	C	1641	3,60	36	1270	2530
BSV-2000 + FL	A3A1H70 VW4A5	C	1958	4,30	43	1370	2510

(*) Versione con flangia



NEXYA S4 E

Monosplit inverter a parete alta in classe A++

		Prezzo da 1<>9		Promo Oltre 10		
Riferimenti	Codice	Listino A	Listino B	Codice	Listino A	Listino B
9000 Btu	NS409	589,06 €	653,86 €	NS409P	530,20 €	588,52 €
12000 Btu	NS412	643,97 €	714,81 €	NS412P	579,63 €	643,38 €
18000 Btu	NS418	1103,23 €	1224,59 €	NS418P	993,00 €	1102,23 €
24000 Btu	NS424	1343,64 €	1491,44 €	NS424P	1209,39 €	1342,42 €



Multi Split Dual 18000

		Prezzo da 1<>9		Promo Oltre 10		
Riferimenti	Codice	Listino A	Listino B	Codice	Listino A	Listino B
U.E. 18000	CEMYH18EI	1128,43 €	1252,55 €	CEMYH18EIP	1036,31 €	1150,30 €
U.I. 9000	SENEH09	221,34 €	245,69 €	SENEH09P	203,28 €	225,64 €
U.I. 12000	SENEH12	231,16 €	256,59 €	SENEH12P	212,29 €	235,64 €



		Prezzo da 1<>9		Promo Oltre 10		
Riferimenti	Codice	Listino A	Listino B	Codice	Listino A	Listino B
U.E. S2	02004	3856,88 €	4281,14 €	02004P	3692,76 €	4098,97 €
U.I. TOWER S2	02044	10653,99 €	11825,93 €	02044P	10200,63 €	11322,70 €



Ci2 WALL

		Prezzo da 1<>9		Promo Oltre 10		
Riferimenti	Codice	Listino A	Listino B	Codice	Listino A	Listino B
1200 Kw 270	99283	776,65 €	862,08 €	99283P	776,65 €	862,08 €
1400 Kw 380	99281	1031,62 €	1145,10 €	99281P	980,04 €	1087,85 €



SHERPA MONOBLOC S2

		Prezzo da 1<>9		Promo Oltre 10		
Riferimenti	Codice	Listino A	Listino B	Codice	Listino A	Listino B
S2 E 6	02303	4158,28 €	4615,69 €	02303P	4158,28 €	4615,69 €
S2 E 8	02304	4530,27 €	5028,60 €	02304P	4530,27 €	5028,60 €
S2 E 10	02305	4620,31 €	5128,54 €	02305P	4620,31 €	5128,54 €
S2 E 12	02306	5983,30 €	6641,46 €	02306P	5983,30 €	6641,46 €
S2 E 14	02307	6867,32 €	7622,72 €	02307P	6867,32 €	7622,72 €
S2 E 16	02308	7395,57 €	8209,08 €	02308P	7395,57 €	8209,08 €
S2 E 12 T	02309	5852,37 €	6496,13 €	02309P	5852,37 €	6496,13 €
S2 E 14 T	02310	6160,40 €	6838,04 €	02310P	6160,40 €	6838,04 €
S2 E 16 T	02311	6622,43 €	7350,90 €	02311P	6622,43 €	7350,90 €

collaudo 2+1 anno
garanzia 150,00 € al tecnico



Ventilconvettore SI Smart Incluso Comando
A Bordo B0872 tuch con telecomando

	Prezzo da 1<>9			Promo Oltre 10		
Riferimenti	Codice	Listino A	Listino B	Codice	Listino A	Listino B
200 B	02122	632,12 €	701,66 €	02122P	605,22 €	671,80 €
400 B	02123	687,49 €	763,11 €	02123P	658,24 €	730,64 €
600 B	02124	775,16 €	860,42 €	02124P	742,17 €	823,81 €
800 B	02125	904,35 €	1003,83 €	02125P	865,87 €	961,11 €
1000 B	02126	955,10 €	1060,17 €	02126P	914,46 €	1015,05 €



OLIMPIA
SPLENDID



Valvola 3 vie Optional

Riferimenti	Codice	Listino A	Listino B	Codice	Listino A	Listino B
Valv. 3 vie	B0834	203,02 €	225,35 €	B0834P	194,38 €	215,76 €



Bi2 NAKED SLI SLIR
Terminali ultraslim, versioni SLI

	Prezzo da 1<>9			Promo Oltre 10		
Riferimenti	Codice	Listino A	Listino B	Codice	Listino A	Listino B
SLI 200 DC	01513	379,81 €	421,59 €	01513P	363,65 €	403,65 €
SLI 400 DC	01514	424,49 €	471,18 €	01514P	406,43 €	451,13 €
SLI 600 DC	01515	542,61 €	602,29 €	01515P	519,52 €	576,66 €
SLI 800 DC	01516	639,51 €	709,86 €	01516P	612,30 €	679,65 €
SLI 1100 DC	02363	723,89 €	803,52 €	02363P	693,09 €	769,33 €
SLI 1400 DC	02056	849,01 €	942,40 €	02056P	812,88 €	902,29 €
SLI 1600 DC	02057	947,30 €	1051,50 €	02057P	906,99 €	1006,76 €

Compatibile con: SIOS CONTROL Bi2 NAKED SLI SLIR Terminali ultraslim, versioni SLI e SLIR



Comando a Bordo Optional

Riferimenti	Codice	Listino A	Listino B	Codice	Listino A	Listino B
Comando a Bordo	B0872	139,76 €	155,13 €	B0872P	128,35 €	142,47 €

Accessori: Griglie, Plenum, Cassoni e Accessori quotate su richiesta

Pannello di chiusura RAL 9003
Griglia di mandata aria con profilo alare

Kit aspirazione Cassaforma per incasso
Pannello di chiusura RAL 9010

Olimpia Kit Cronotermostato fino a 30 unità Lcd Optional

Riferimenti	Codice	Listino A	Listino B	Codice	Listino A	Listino B
Crono Parete	B0736	186,62 €	207,14 €	B0736P	178,68 €	198,33 €
Valv. 3 vie	B0834	203,02 €	225,35 €	B0834P	194,38 €	215,76 €



Bi2 WALL
Terminali high-wall

	Prezzo da 1<>9			Promo Oltre 10		
Riferimenti	Codice	Listino A	Listino B	Codice	Listino A	Listino B
400 V2V	01784	884,76 €	982,08 €	01784P	847,11 €	940,29 €
600 V2V	01785	960,75 €	1066,43 €	01785P	919,86 €	1021,05 €
800 V2V	01786	1036,69 €	1150,73 €	01786P	992,58 €	1101,76 €
400 V3V	01787	924,97 €	1026,72 €	01787P	885,61 €	983,03 €
600 V3V	01788	996,47 €	1106,09 €	01788P	954,07 €	1059,02 €
800 V4V	01789	1063,48 €	1180,47 €	01789P	1018,23 €	1130,24 €
1200 V3V	02457	1181,61 €	1311,59 €	02457P	1131,33 €	1255,77 €
1400 V3V	02461	1224,35 €	1359,03 €	02461P	1172,25 €	1301,20 €

Bi2 WALL
Terminali high-wall



NEXYA S5 E CEILING

Monosplit inverter per grandi ambienti



ALTA EFFICIENZA

Gas refrigerante R32 ad alte prestazioni e massima efficienza tecnologica, per raggiungere la classe energetica A++.



Pavimento Soffitto Monosplit

		Prezzo da 1<>9		Promo Oltre 10		
Riferimenti	Codice	Listino A	Listino B	Codice	Listino A	Listino B
U.I. 18000	CEILING18	929,39 €	1031,62 €	CEILING18P	818,08 €	908,07 €
U.I. 24000	CEILING24	1021,98 €	1134,39 €	CEILING24P	899,57 €	998,53 €
U.I. 36000	CEILING36	1200,12 €	1332,13 €	CEILING36P	1056,38 €	1172,58 €
U.I. 48000	CEILING48	1323,18 €	1468,73 €	CEILING48P	1164,70 €	1292,82 €

NEXYA S5 E DUCT

Monosplit inverter canalizzato per grandi ambienti



Duct Canalizzato Monosplit

		Prezzo da 1<>9		Promo Oltre 10		
Riferimenti	Codice	Listino A	Listino B	Codice	Listino A	Listino B
U.I. 18000	OS-SANDH18EI	1101,68 €	1222,86 €	OS-SANDH18EIP	921,24 €	1022,58 €
U.I. 24000	OS-SANDH24EI	1249,34 €	1386,77 €	OS-SANDH24EIP	1099,71 €	1220,68 €
U.I. 36000	OS-SANDH36EI	1452,10 €	1611,83 €	OS-SANDH36EIP	1278,18 €	1418,78 €
U.I. 48000	OS-SANDH48EI	1550,54 €	1721,10 €	OS-SANDH48EIP	1364,84 €	1514,97 €

CASSETTE



CASSETTA

		Prezzo da 1<>9		Promo Oltre 10		
Riferimenti	Codice	Listino A	Listino B	Codice	Listino A	Listino B
U.I. 18000	OS-K/SANCH18I	843,83 €	936,66 €	OS-K/SANCH18IP	742,77 €	824,47 €
U.I. 24000	OS-K/SANCH24I	864,93 €	960,07 €	OS-K/SANCH24IP	761,34 €	845,08 €
U.I. 36000	OS-K/SANCH36I	1050,10 €	1165,62 €	OS-K/SANCH36IP	924,33 €	1026,01 €
U.I. 48000	OS-K/SANCH48I	1170,82 €	1299,61 €	OS-K/SANCH48IP	1030,59 €	1143,96 €

Unità Esterna commerciale Monosplit

		Prezzo da 1<>9		Promo Oltre 10		
Riferimenti	Codice	Listino A	Listino B	Codice	Listino A	Listino B
U.E. 18000	OS-CANCH18EI	1542,10 €	1711,73 €	OS-CANCH18EIP	1289,53 €	1431,38 €
U.E. 24000	OS-CANCH124EI	1893,68 €	2101,99 €	OS-CANCH124EIP	1583,54 €	1757,73 €
U.E. 36000	OS-CANCH36EI	3022,50 €	3354,98 €	OS-CANCH36EIP	2527,48 €	2805,50 €
U.E. 36000	OS-CANCHT36EI	3041,01 €	3375,52 €	OS-CANCHT36EIP	2542,95 €	2822,67 €
U.E. 48000	OS-CANCHT48EI	4188,32 €	4649,04 €	OS-CANCHT48EIP	3502,36 €	3887,62 €





Unità Esterna Multisplit Serie 5



NEXYA S4 E MULTISPLIT

Multisplit inverter per piccoli e grandi ambienti

Prezzo da 1<>9

Promo Oltre 10

Riferimenti	Codice	Listino A	Listino B	Codice	Listino A	Listino B
U.E. 18000	OS-CANMH18EI	1299,37 €	1442,30 €	OS-CANMH18EIP	1082,17 €	1201,21 €
U.E. 21000	OS-CANMH21EI	1928,59 €	2140,74 €	OS-CANMH21EIP	1606,24 €	1782,92 €
U.E. 28000	OS-CEMYH28EI	2853,49 €	3167,37 €	OS-CEMYH28EIP	2386,14 €	2648,62 €
U.E. 42000	OS-CANMH42EI	3863,87 €	4288,90 €	OS-CANMH42EIP	3231,04 €	3586,46 €



Unità Interna Multi Splt

Prezzo da 1<>9

Promo Oltre 10

Riferimenti	Codice	Listino A	Listino B	Codice	Listino A	Listino B
U.I. 9000	OS-SENEH09EI	220,44 €	244,69 €	OS-SENEH09EIP	209,42 €	232,46 €
U.I. 12000	OS-SENEH12EI	230,21 €	255,53 €	OS-SENEH12EIP	218,70 €	242,76 €
U.I. 18000	OS-SENEH18EI	376,81 €	418,26 €	OS-SENEH18EIP	357,97 €	397,35 €



Duct Canalizzato Multisplit

Prezzo da 1<>9

Promo Oltre 10

Riferimenti	Codice	Listino A	Listino B	Codice	Listino A	Listino B
U.I. 9000	OS-SANDH09EI	885,02 €	982,37 €	OS-SANDH09EIP	840,77 €	933,26 €
U.I. 12000	OS-SANDH12EI	906,74 €	1006,48 €	OS-SANDH12EIP	861,40 €	956,16 €
U.I. 18000	OS-SANDH18EI	1101,68 €	1222,86 €	OS-SANDH18EIP	921,24 €	1022,58 €



CASSETTA Multisplit

Prezzo da 1<>9

Promo Oltre 10

Riferimenti	Codice	Listino A	Listino B	Codice	Listino A	Listino B
U.I. 9000	OS-CURSAL/SANCH09I	748,20 €	830,50 €	OS-CURSAL/SANCH09IP	710,79 €	788,97 €
U.I. 12000	OS-CURSAL/SANCH12I	772,09 €	857,02 €	OS-CURSAL/SANCH12IP	733,48 €	814,17 €
U.I. 18000	OS-CURSAL/SANCH18I	781,86 €	867,86 €	OS-CURSAL/SANCH18IP	781,86 €	867,86 €



NEXYA S4 E MULTISPLIT

Multisplit inverter per piccoli e grandi ambienti



cod. 02453 Climatizzatore UNICO EVO 20
HP PVAN R290

Prezzo da 1<>9

Promo Oltre 10

Riferimenti	Codice	Listino A	Listino B	Codice	Listino A	Listino B
20 Hp R290	OL02453	2729,59 €	3029,84 €	OL02453P	2493,70 €	2768,01 €
25 Hp R290	OL02455	2884,61 €	3201,92 €	OL02455P	2635,32 €	2925,20 €



cod. 02133 Climatizzatore UNICO EDGE
30 HP RFA R410 On Off

Prezzo da 1<>9

Promo Oltre 10

Riferimenti	Codice	Listino A	Listino B	Codice	Listino A	Listino B
OL02133	OL02133	2453,26 €	2723,12 €	OL02133P	2241,25 €	2487,79 €



cod. 02115 Climatizzatore UNICO EDGE
30 HP Eva R32 Inverter

Prezzo da 1<>9

Promo Oltre 10

Riferimenti	Codice	Listino A	Listino B	Codice	Listino A	Listino B
OL02115	OL02115	2739,99 €	3041,39 €	OL02115P	2710,25 €	3008,38 €



CANALINA PRATIC

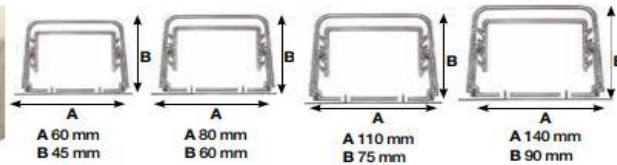
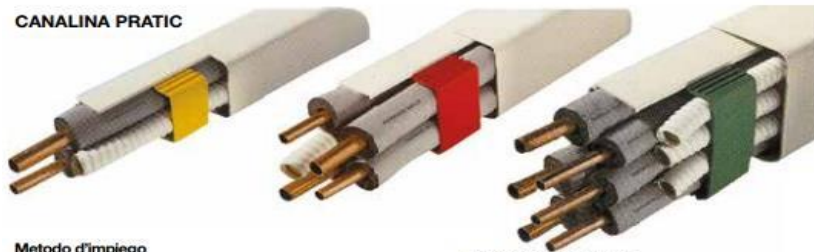

Metodo d'impiego

Fissare la base con i relativi tasselli ad espansione, con passo max 600 mm.

Completare l'impianto utilizzando gli accessori necessari ed inserire i tubi in rame ed i cavi fissandoli in corrispondenza dei tasselli con le staffe di bloccaggio.

Fissare il coperchio ad incastro.

N.B. Le staffe di bloccaggio sono rimovibili con una lieve divaricazione delle pareti

Caratteristiche tecniche

- materiale: PVC UL 94 V0 auto estinguente
- temperatura d'esercizio: - 20°C / +60°C
- colore: bianco RAL 9001 verniciabile



Base Canale C/Coperchio 1Mt



Curva Piana 0607CP

Codice	Riferimenti	Listino A	Listino B	Off.	Box
0612BC	60x45	3,27 €	3,63 €	1	10
0712BC	70x55	3,26 €	3,62 €	1	10
0812BC	80x60	4,76 €	5,28 €	1	10
0912BC	90x65	5,20 €	5,77 €	1	10
1212BC	120x75	5,62 €	6,24 €	1	10
1412BC	140x90	8,51 €	9,44 €	1	10

Codice	Riferimenti	Listino A	Listino B	Off.	Box
0607CP	60x45	2,19 €	2,43 €	1	10
0707CP	70x55	2,05 €	2,28 €	1	10
0807CP	80x60	3,03 €	3,36 €	1	10
0907CP	90x65	2,81 €	3,12 €	1	10
1207CP	120x75	3,45 €	3,83 €	1	10
1407CP	140x90	4,83 €	5,36 €	1	10



Passaggio Muro 0610PM



Curva A Muro 0609CM

Codice	Riferimenti	Listino A	Listino B	Off.	Box
0610PM	60x45	2,08 €	2,31 €	1	10
0710PM	70x55	1,91 €	2,12 €	1	10
0810PM	80x60	2,65 €	2,94 €	1	10
0910PM	90x65	2,47 €	2,74 €	1	10
1210PM	120x75	3,06 €	3,40 €	1	10
	140x90				

Codice	Riferimenti	Listino A	Listino B	Off.	Box
0609CM	60x45	2,79 €	3,09 €	1	10
0709CM	70x55	2,58 €	2,87 €	1	10
0809CM	80x60	3,45 €	3,83 €	1	10
0909CM	90x65	3,20 €	3,55 €	1	10
1209CM	120x75	3,74 €	4,15 €	1	10
	140x90				



Tappo Terminale Type 06
0608IT



Angolo Esterno 0606AE

Codice	Riferimenti	Listino A	Listino B	Off.	Box
0608IT	60x45	1,71 €	1,90 €	1	10
0708IT	70x55	1,66 €	1,84 €	1	10
0808IT	80x60	1,97 €	2,18 €	1	10

Codice	Riferimenti	Listino A	Listino B	Off.	Box
0606AE	60x45	1,91 €	2,11 €	1	10
0706AE	70x55	1,80 €	2,00 €	1	10
0806AE	80x60	2,19 €	2,43 €	1	10



Cassetta Un.Prdisp. Condizio.
CPC



Angolo Interno 0605AI

Codice	Riferimenti	Listino A	Listino B	Off.	Box
CPC		5,51 €	6,11 €	1	1
CPC144	Offertax144	5,10 €	5,66 €	144	144

Codice	Riferimenti	Listino A	Listino B	Off.	Box
0605AI	60x45	1,91 €	2,11 €	1	10
0705AI	70x55	1,80 €	2,00 €	1	10
0805AI	80x60	2,19 €	2,43 €	1	10



Supporto Antivibrante D. 40 X
H.40 A Terra 107042

Codice	Riferimenti	Listino A	Listino B	Conf.	Box
107042	4 PZ	11,73 €	13,02 €	1	10



Supporto Antivibrante D. 30 X
H.20 A Terra 107040

Codice	Riferimenti	Listino A	Listino B	Conf.	Box
107040	4 PZ	5,21 €	5,79 €	1	10



Raccordo A Y Scarico Condensa
0021GY

Codice	Riferimenti	Listino A	Listino B	Conf.	Box
0021GY	Racc. "Y"	1,01 €	1,12 €	1	10



Sifone Condensa 0024SF

Codice	Riferimenti	Listino A	Listino B	Conf.	Box
0024SF	Sifone	2,21 €	2,46 €	1	10



Raccordo Retto Condensa 0023GL

Codice	Riferimenti	Listino A	Listino B	Conf.	Box
0023GL	Racc. Retto	0,70 €	0,78 €	1	10



Raccordo A "T" Condensa 0025GT

Codice	Riferimenti	Listino A	Listino B	Conf.	Box
0025GT	Racc. "T"	1,61 €	1,79 €	1	10



Bocchettone Per Raccordo 1/4" 81625AB05

Codice	Riferimenti	Listino A	Listino B	Conf.	Box
81625AB05	D. 1/4"	1,01 €	1,12 €	1	10
81625AC05	D. 3/8"	1,43 €	1,58 €	1	10
81625AD05	D. 1/2"	2,26 €	2,51 €	1	10



Bocchettone Per Raccordo 1/4"
81620AB05

Codice	Riferimenti	Listino A	Listino B	Conf.	Box
81620AB05	D. 1/4"	0,82 €	0,91 €	1	10
81620AC05	D. 3/8"	1,22 €	1,36 €	1	10
81620AD05	D. 1/2"	1,43 €	1,59 €	1	10



Supporto A Pavimento A Cono
0501SC

Codice	Riferimenti	Listino A	Listino B	Conf.	Box
0501SC		3,03 €	3,36 €	1	10
0502PT		0,50 €	0,55 €	1	10



Supporto A Pavimento Mm.350
Pezzo Singolo 0350SP

Codice	Riferimenti	Listino A	Listino B	Conf.	Box
0350SP	Cm. 35	5,14 €	5,70 €	1	10
0450SP	Cm. 45	5,95 €	6,60 €	1	10
1000SP	Cm. 1000	8,93 €	9,91 €	1	10
0341TS	Coperchio	0,95 €	1,06 €	1	10



Kit Coppia Staffe Con
Accessori E Barra
SP 12/10

Codice	Riferimenti	Listino A	Listino B	Conf.	Box
BSC02	380X380X800	18,09 €	20,08 €	1	10
BSC04	410X380X800	19,27 €	21,39 €	1	10
BSC05	450X350X800	19,27 €	21,39 €	1	10
BSC03	480X380X800	19,27 €	21,39 €	1	10

PROMO



Tubo Scarico Condensa Mm. 16
Rotolo Mt 30 TC16

Codice	Riferimenti	Listino A	Listino B	Conf.	Box
TC16	D. 16	0,99 €	1,10 €	30	300
TC20	D. 20	1,02 €	1,14 €	30	300



KIT VALIGETTA CON GRUPPO
MANOMETRICO GM-2-S2-C1-80-
PF-KIT-V - R32/410 05007050

Codice	Riferimenti	Listino A	Listino B	Conf.	Box
05007050		158,34 €	175,76 €	1	10



Bilancia elettronica per bombola
a gas Kg100 - 5 grammi BE100/5

Codice	Riferimenti	Listino A	Listino B	Conf.	Box
BE100/5		211,08 €	234,29 €	1	10



Cartellatrice Universale
Per Tubi In Pollici Da 3/16" A
5/8"
Per Tubi In Millimetri Da 5 A 16
CUE

Codice	Riferimenti	Listino A	Listino B	Conf.	Box
CUE		30,89 €	34,29 €	1	10



Pompa Scarico Condensa 600
Lt/H Zz Nth10.1 117310

Codice	Riferimenti	Listino A	Listino B	Conf.	Box
117310		86,60 €	96,13 €	1	30
117310x2	Offertax2	81,60 €	90,58 €	2	30
117310x5	Offertax5	78,27 €	86,88 €	5	30
117310x10	Offertax10	74,94 €	83,19 €	10	30



Deflettore d'aria

Codice	Riferimenti	Listino A	Listino B	Conf.	Box
DD5001		Arrivo	Arrivo	1	30
DD5002		Arrivo	Arrivo	1	30
DD5003		Arrivo	Arrivo	1	30



Climatizzatore Portatile
Compatto Olimpia Splendid Che
Deumidifica Dolceclima Compact
8 P 2,64Kw A Gas R290 01921

Codice	Riferimenti	Listino A	Listino B	Conf.	Box
01921		580,45 €	644,30 €	1	30



inza amperometrica AC/DC DT-333

Codice	Riferimenti	Listino A	Listino B	Conf.	Box
DT-333		126,73 €	140,67 €	1	10



Cercafughe elettronico 29027007

Codice	Riferimenti	Listino A	Listino B	Conf.	Box
29027007	Seeker	200,29 €	222,32 €	1	10



Kit Cartellatrice Universale
Per Tubi In Pollici Da 3/16" A 5/8"
Per Tubi In Millimetri Da 5 A 16
Completa Di:
- Tagliatubi Da 3 A 22 Mm
- Sbravatubi Girevoli Con Lama Di
Ricambio CT806AMLC

Codice	Riferimenti	Listino A	Listino B	Conf.	Box
CT806AMLC		73,08 €	81,12 €	1	10



POMPE VUOTO



SERIE BM Doppio stadio
BM Double stage series

Codice	Riferimenti	Listino A	Listino B	Conf.	Box
PV2BM-71LM	DS2BM-71LM	310,94 €	345,15 €	1	30
PV4BM-127LM	DS4BM-127LM	390,10 €	433,01 €	1	30
PV8BM-241LM	DS8BM-241LM	588,72 €	653,48 €	1	30
PV10BM-297LM	DS10BM-297LM	685,84 €	761,29 €	1	30



Bacinella raccoglicondensa

Codice	Riferimenti	Listino A	Listino B	Conf.	Box
0079BR	790x390	Arrivo	Arrivo	1	30
0094BR	940x420	Arrivo	Arrivo	1	30



Deumidificatore G3 Ferrari 10 Lt
210W G9000100

Codice	Riferimenti	Listino A	Listino B	Conf.	Box
G9000100		189,13 €	209,93 €	1	30

?

RUBINETTERIE

Rubinetti da Bagno



Rubinetti da Bagno



Rubinetti da Bagno



Rubinetti Cucina



Rubinetti Cucina

Miscelatore Bidet Serie Nx

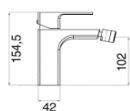

Codice	Riferimenti	Listino A	Listino B	Off.	Box
MXBIMCNXCCR	Cromo	72,61 €	80,60 €	1	5

MXBIMCNXCCR

Miscelatore Vasca Completo Di Doccia Flex E Supporto Serie Nx

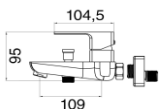

Codice	Riferimenti	Listino A	Listino B	Off.	Box
MXVAMCNXCCR	Cromo	86,18 €	95,66 €	1	5

MXVAMCNXCCR

Miscelatore lavabo alto cromato MXLHMCNXCCR

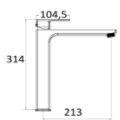

Codice	Riferimenti	Listino A	Listino B	Off.	Box
MXLHMCNXCCR	Cromo	188,55 €	209,29 €	1	5

MXLHMCNXCCR

Miscelatore lavabo prolungato cromato MXLLMCNXCCR

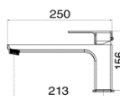

Codice	Riferimenti	Listino A	Listino B	Off.	Box
MXLLMCNXCCR	Cromo	109,99 €	122,09 €	1	5

MXLLMCNXCCR

Mix Doccia a Parete Completo di flex, supporto a parete e doccia monogetto

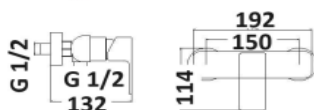

Codice	Riferimenti	Listino A	Listino B	Off.	Box
MXEDMCNXCCR	Cromo	75,83 €	84,17 €	1	5

MXEDMCNXCCR

Miscelatore Lavabo Serie

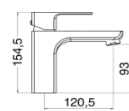

Codice	Riferimenti	Listino A	Listino B	Off.	Box
MXLAMCNXCCR	Cromo	72,61 €	80,60 €	1	5

MXLAMCNXCCR

Miscelatore Doccia Incasso Con Deviatore Serie Nx Piastra Quadra

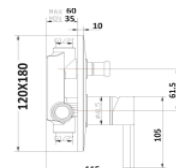

Codice	Riferimenti	Listino A	Listino B	Off.	Box
MXDDMCNXQCR	Cromo	84,73 €	94,05 €	1	5

MXDDMCNXQCR

Miscelatore Lavabo a Parete

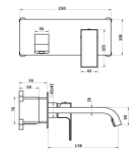

Codice	Riferimenti	Listino A	Listino B	Off.	Box
MXLQMCNX3CR	Cromo	163,96 €	181,99 €	1	5

MXLQMCNX3CR

Miscelatore doccia incasso una via cromato MXDIMCNXQCR

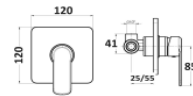

Codice	Riferimenti	Listino A	Listino B	Off.	Box
MXDIMCNXQCR	Cromo	54,47 €	60,46 €	1	5

MXDIMCNXQCR

Lavello Cucina Canna Alta Sphera "Stile" MXCUMCNXCCR

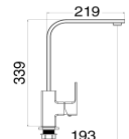

Codice	Riferimenti	Listino A	Listino B	Off.	Box
MXCUMCNXCCR	Cromo	105,76 €	117,40 €	1	5

MXCUMCNXCCR



Lavabo Monocomando Serie Mm
MXLAMCMMCCR

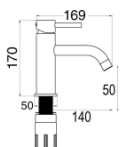

Codice	Riferimenti	Listino A	Listino B	Off.	Box
MXLAMCMMCCR	Cromo	65,99 €	73,25 €	1	5

MXLAMCMMCCR



Bidet Monocomando Serie Mm
MXBIMCMMCCR

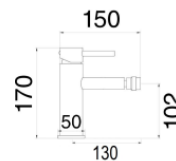

Codice	Riferimenti	Listino A	Listino B	Off.	Box
MXBIMCMMCCR	Cromo	65,99 €	73,25 €	1	5

MXBIMCMMCCR



Lavabo Alto Serie Mm
MXLHMCMMCCR

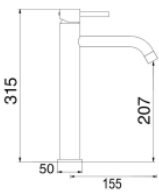

Codice	Riferimenti	Listino A	Listino B	Off.	Box
MXLHMCMMCCR	Cromo	89,04 €	98,83 €	1	5

MXLHMCMMCCR



Lavabo Incasso Cromato Serie
Mm MXLIMCMMCCR

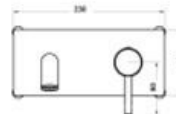

Codice	Riferimenti	Listino A	Listino B	Off.	Box
MXLIMCMMCCR	Cromo	104,75 €	116,27 €	1	5

MXLIMCMMCCR



Mix Doccia a Parete Completo di
flex, supporto a parete e doccia
monogetto

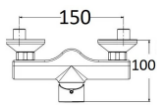

Codice	Riferimenti	Listino A	Listino B	Off.	Box
MXEDMCMMCCR	Cromo	Arrivo	Arrivo	1	5

MXEDMCMMCCR



Miscelatore Doccia Incasso Con
Deviatore Serie Mm
MXDDMCMM3CR

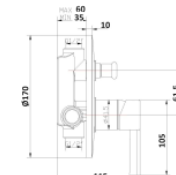

Codice	Riferimenti	Listino A	Listino B	Off.	Box
MXDDMCMM3CR	Cromo	64,95 €	72,09 €	1	5

MXDDMCMM3CR



Mix Vasca Completo di flex,
supporto a parete e doccia
monogetto

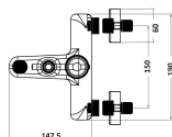

Codice	Riferimenti	Listino A	Listino B	Off.	Box
MXVAMCMM3CR	Cromo	98,37 €	109,19 €	1	5

MXVAMCMM3CR



Miscelatore Doccia Incasso Una
Via Cromato MXDIMCMM3CR

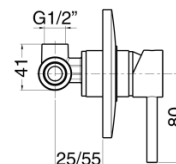

Codice	Riferimenti	Listino A	Listino B	Off.	Box
MXDIMCMM3CR	Cromo	51,33 €	56,97 €	1	5

MXDIMCMM3CR



Lavabo Cucina Canna Alta Serie
Mm Cromo MXCUMCMMCCR



Codice	Riferimenti	Listino A	Listino B	Off.	Box
MXCUMCMMCCR	Cromo	61,80 €	68,60 €	1	5

MXCUMCMMCCR



Miscelatore incasso 3 vie
composto da:
deviatore meccanico con easy
box
placca esterna

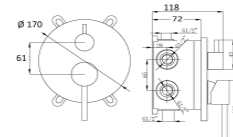

Codice	Riferimenti	Listino A	Listino B	Off.	Box
RU3V35MM3CR	Cromo	128,09 €	142,18 €	1	5

RU3V35MM3CR



Miscelatore lavabo composto da:
piletta pop up 1" 1/4
2 flessibili 3/8" F
aeratore 24x1 M

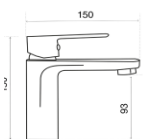

Codice	Riferimenti	Listino A	Listino B	Off.	Box
MXLAMCHHCCR	Cromo	57,38 €	63,70 €	1	5

MXLAMCHHCCR



Bidet Monocomando Cromato
Serie Hh MXBIMCHHCCR

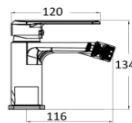

Codice	Riferimenti	Listino A	Listino B	Off.	Box
MXBIMCHHCCR	Cromo	44,28 €	49,15 €	1	5

MXBIMCHHCCR



Miscelatore esterno doccia
composto da: kit doccia
flessibile doppia aggraffatura 150
cm supporto snodato
doccia multigetto



Codice	Riferimenti	Listino A	Listino B	Off.	Box
MXEDMCHHCCR	Cromo	73,78 €	81,90 €	1	5

MXEDMCHHCCR



Miscelatore vasca completo di kit
doccia,
flessibile, supporto e doccia multi
getto MXVAMCHHCCR

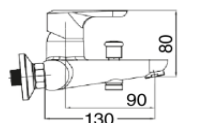

Codice	Riferimenti	Listino A	Listino B	Off.	Box
MXVAMCHHCCR	Cromo	72,28 €	80,23 €	1	5

MXVAMCHHCCR



Miscelatore incasso doccia serie
HH una via
piastra quadra MXDIMCHHCCR

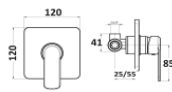

Codice	Riferimenti	Listino A	Listino B	Off.	Box
MXDIMCHHCCR	Cromo	50,28 €	55,81 €	1	5

MXDIMCHHCCR



Lavabo Alto Serie Hh Con
Scarico Click Clac
MXLHMCHHCCR

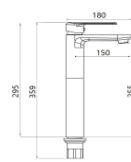

Codice	Riferimenti	Listino A	Listino B	Off.	Box
MXLHMCHHCCR	Cromo	96,65 €	107,29 €	1	5

MXLHMCHHCCR



Miscelatore lavabo incasso
cromato MXLIMCHHCCR

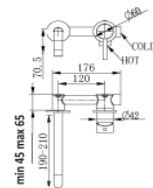

Codice	Riferimenti	Listino A	Listino B	Off.	Box
MXLIMCHHCCR	Cromo	104,75 €	116,27 €	1	5

MXLIMCHHCCR



Miscelatore incasso doccia una
via cromato MXDIMCHH3CR

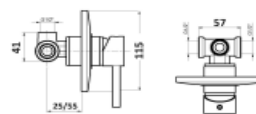

Codice	Riferimenti	Listino A	Listino B	Off.	Box
MXDIMCHH3CR	Cromo	46,09 €	51,16 €	1	5

MXDIMCHH3CR



Miscelatore Doccia Incasso Con
Deviatore, "Hh" In Ottone
Cromato MXDDMCHH3CR

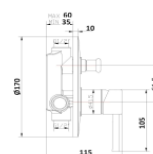

Codice	Riferimenti	Listino A	Listino B	Off.	Box
MXDDMCHH3CR	Cromo	85,17 €	94,53 €	1	5

MXDDMCHH3CR



Lavello Cucina Canna Alta
MXCUMCHHCCR

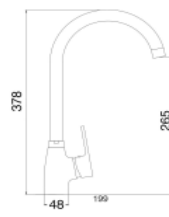

Codice	Riferimenti	Listino A	Listino B	Off.	Box
MXCUMCHHCCR	Cromo	52,83 €	58,64 €	1	5

MXCUMCHHCCR



Mix Lavabo con basetta e flessibili e scarico automatico Cartuccia D. 40

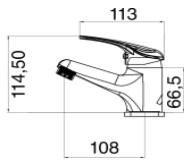

Codice	Riferimenti	Listino A	Listino B	Off.	Box
MLDE00	Cromo	36,41 €	40,42 €	1	5
MXBMC1003CR					



Mix Bidet con basetta e flessibili e scarico automatico Cartuccia D. 40

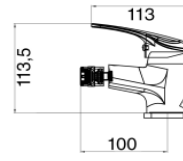

Codice	Riferimenti	Listino A	Listino B	Off.	Box
MBDE00	Cromo	36,41 €	40,42 €	1	5
MXBMC2003CR					



Mix Vasca Debora Ec. C /Dupl. MVDE00

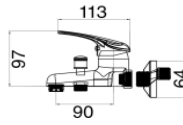

Codice	Riferimenti	Listino A	Listino B	Off.	Box
MVDE00	Cromo	47,77 €	53,03 €	1	5
MXBMC3003CR					



Mix Doccia Esteno Debora MDEDE00

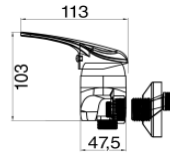

Codice	Riferimenti	Listino A	Listino B	Off.	Box
MDEDE00	Cromo	32,89 €	36,51 €	1	5
MXBMC4003CR					



Mix Debora Doccia Incasso C.40 MDIDE00

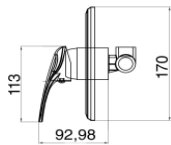

Codice	Riferimenti	Listino A	Listino B	Off.	Box
MDIDE00	Cromo	25,58 €	28,40 €	1	5
MXBMC41W3CR					

Cassetta Predisposizione Doccia Incasso Completa Di Accessori Serie Debora CPDIDE00

Scatola da incasso per doccia completa di placca e miscelatore



Codice	Riferimenti	Listino A	Listino B	Off.	Box
CPDIDE00		63,76 €	70,77 €	1	5



Mix Debora Lav. Mon. C /Bassa MLMDE00

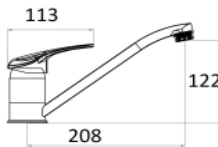

Codice	Riferimenti	Listino A	Listino B	Off.	Box
MLMDE00	Cromo	30,36 €	33,70 €	1	5
MXBMC7003CR					



Mix Lavello Parete Debora Cr. MLPDE00

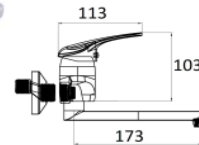

Codice	Riferimenti	Listino A	Listino B	Off.	Box
MLPDE00		42,51 €	47,18 €	1	5
MXBMC6003CR					



Mix Lavello Mon. Later. Debora Canna Alta Pesante Cromo MLMLDE00

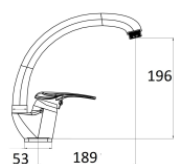

Codice	Riferimenti	Listino A	Listino B	Off.	Box
MLMLDE00		40,49 €	44,94 €	1	5
MXBMC5003CR					



Mix Lav. Mon. Doc /Estr. Debora Cartuccia 40 MLMEDE00

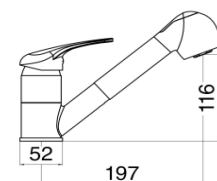

Codice	Riferimenti	Listino A	Listino B	Off.	Box
MLMEDE00	Cromo	106,27 €	117,96 €	1	5
MXBMC8003CR					

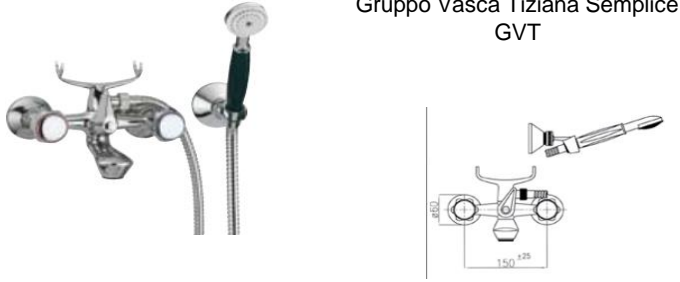

Gruppo Vasca Tiziana Semplice GVT

Codice	Riferimenti	Listino A	Listino B	Off.	Box
GVT	Cromo	56,42 €	62,63 €	1	5

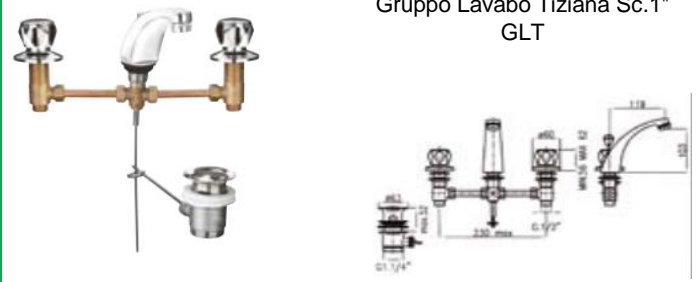

Gruppo Lavabo Tiziana Sc.1" GLT

Codice	Riferimenti	Listino A	Listino B	Off.	Box
GLT	Cromo	62,21 €	69,06 €	1	5

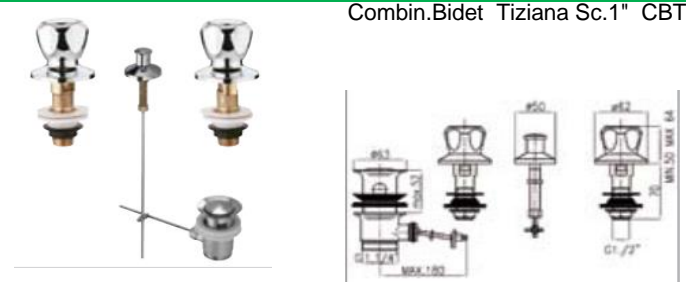

Combin.Bidet Tiziana Sc.1" CBT

Codice	Riferimenti	Listino A	Listino B	Off.	Box
CBT	Cromo	37,95 €	42,13 €	1	5



Gruppo Lavabo Mon. Tiziana GLMT

Codice	Riferimenti	Listino A	Listino B	Off.	Box
GLMT	Cromo	31,37 €	34,82 €	1	5



Rubinetto Bidet Tiziana 1/2" RBT

Codice	Riferimenti	Listino A	Listino B	Off.	Box
RBT	Cromo	15,18 €	16,85 €	1	5



Gruppo Bidet Monoforo Tiziana GBMT

Codice	Riferimenti	Listino A	Listino B	Off.	Box
GBMT	Cromo	43,27 €	48,03 €	1	5

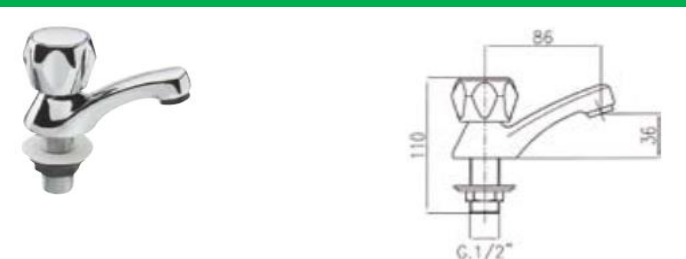

Rubinetto Collo Cigno 1/2" Tiz. RCT

Codice	Riferimenti	Listino A	Listino B	Off.	Box
RCT		21,51 €	21,51 €	1	6
RCTx6	Offertax6	20,63 €	20,63 €	6	6



Rubinetto Incasso Tiziana 1/2" RIT

Codice	Riferimenti	Listino A	Listino B	Off.	Box
RIT	Cromo	20,20 €	22,42 €	1	5

Codice	Riferimenti	Listino A	Listino B	Off.	Box
		Arrivo	Arrivo	1	5

Codice	Riferimenti	Listino A	Listino B	Off.	Box
		Arrivo	Arrivo	1	5



Miscelatore cucina con canna flessibile in silicone nero composto da: attacco a forcella magnetico in ottone cromato soffione 2 getti

MXCUMC293NE
by **GAY**
rubinetterie

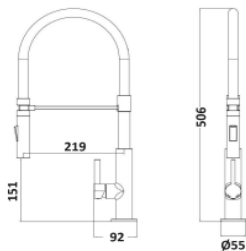

Codice	Riferimenti	Listino A	Listino B	Off.	Box
MXCUMC293NE		174,21 €	193,38 €	1	5

MXCUMC293NE



Miscelatore cucina con canna flessibile in silicone grigio composto da: attacco a forcella magnetico in ottone cromato soffione 2 getti

MXCUMC293AG
by **GAY**
rubinetterie

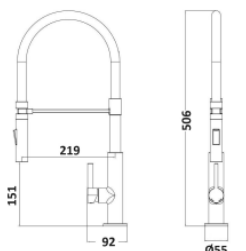

Codice	Riferimenti	Listino A	Listino B	Off.	Box
MXCUMC293AG		174,21 €	193,38 €	1	5

MXCUMC293AG



Miscelatore cucina con canna flessibile in silicone grigio composto da: attacco a forcella magnetico in ottone cromato soffione un getto

MXCUMC273AG
by **GAY**
rubinetterie

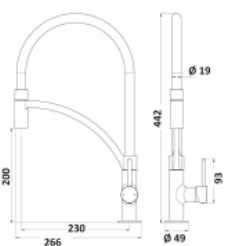

Codice	Riferimenti	Listino A	Listino B	Off.	Box
MXCUMC273AG		143,47 €	159,25 €	1	5

MXCUMC273AG



Miscelatore cucina con canna a molla flessibile composto da: attacco a forcella magnetico in ottone cromato soffione 2 getti

by **GAY**
rubinetterie

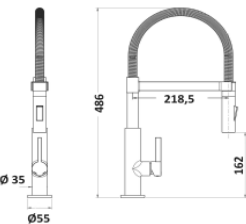

Codice	Riferimenti	Listino A	Listino B	Off.	Box
MXCUMC313CR		184,45 €	204,74 €	1	5

MXCUMC313CR



Setcucina C/Molla,Sof.Sd4011
RU0011003CR

SPHERA®
DOCCE & ACCESSORI

Codice	Riferimenti	Listino A	Listino B	Off.	Box
RU0011003CR		191,28 €	212,32 €	1	5

RU0011003CR



Miscelatore cucina con canna flessibile in silicone bianco composto da: attacco a forcella magnetico in ottone cromato soffione 2 getti

MXCUMC293BI
by **GAY**
rubinetterie

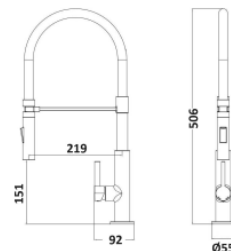

Codice	Riferimenti	Listino A	Listino B	Off.	Box
MXCUMC293BI		174,21 €	193,38 €	1	5

MXCUMC293BI



Miscelatore cucina con canna flessibile in silicone nero composto da: attacco a forcella magnetico in ottone cromato soffione un getto

MXCUMC273NE
by **GAY**
rubinetterie

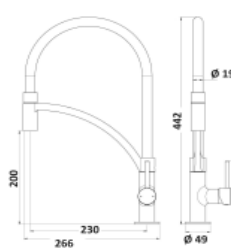

Codice	Riferimenti	Listino A	Listino B	Off.	Box
MXCUMC273NE		143,47 €	159,25 €	1	5

MXCUMC273NE



Miscelatore cucina con canna flessibile in silicone bianco composto da: attacco a forcella magnetico in ottone cromato soffione un getto

by **GAY**
rubinetterie

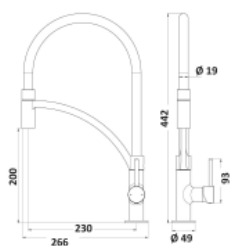

Codice	Riferimenti	Listino A	Listino B	Off.	Box
MXCUMC273BI		143,47 €	159,25 €	1	5

MXCUMC273BI



Miscelatore cucina con molla
MXCMMMCCR

by **GAY**
rubinetterie

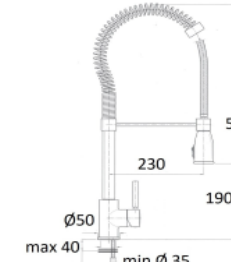

Codice	Riferimenti	Listino A	Listino B	Off.	Box
MXCMMMCCR		303,77 €	337,19 €	1	5

MXCMMMCCR



Miscelatore cucina con molla
MXCMMCSACCR

by **GAY**
rubinetterie

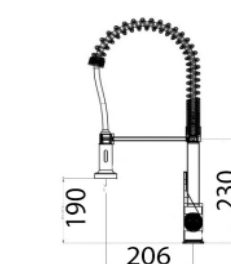

Codice	Riferimenti	Listino A	Listino B	Off.	Box
MXCMMCSACCR		167,60 €	186,04 €	1	5

MXCMMCSACCR



Miscelatore cucina con doccia estraibile in ottone cromato
MXES00003CR

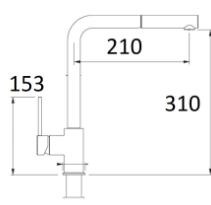

Codice	Riferimenti	Listino A	Listino B	Off.	Box
MXES00003CR		115,22 €	127,90 €	1	5
MXES00003CR					



Miscelatore cucina con doccia estraibile in ottone nero opaco
MXES00003NO

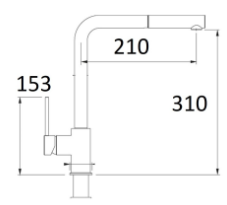

Codice	Riferimenti	Listino A	Listino B	Off.	Box
MXES00003NO		144,55 €	160,46 €	1	5
MXES00003NO					



Miscelatore cucina con doccia estraibile in ottone nichel spazzolato
MXES00003NS

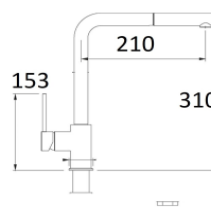

Codice	Riferimenti	Listino A	Listino B	Off.	Box
MXES00003NS	Nichel spazzolato	165,50 €	183,71 €	1	5
MXES00003NS					



Miscelatore cucina con canna abbattibile Nichel spazzolato

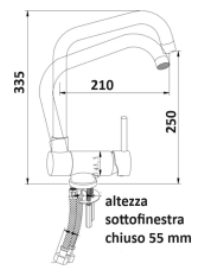

Codice	Riferimenti	Listino A	Listino B	Off.	Box
MXKWA0003NS	Nichel spazzolato	97,35 €	108,06 €	1	5
MXKWA0003NS					



Miscelatore cucina con canna abbattibile Cromato



Codice	Riferimenti	Listino A	Listino B	Off.	Box
MXKWA0003CR	Cromato	87,10 €	96,68 €	1	5
MXKWA0003CR					



Miscelatore cucina con canna abbattibile Nero Opaco

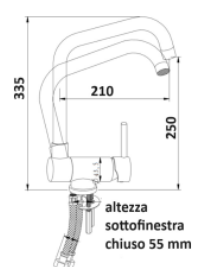

Codice	Riferimenti	Listino A	Listino B	Off.	Box
MXKWA0003NO	Nero Opaco	97,35 €	108,06 €	1	5
MXKWA0003NO					



Miscelatore cucina canna flessibile e girevole colore nero
MXCU000FLCNE

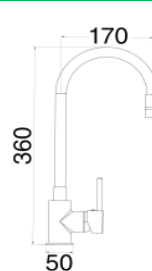

Codice	Riferimenti	Listino A	Listino B	Off.	Box
MXCU000FLCNE		79,61 €	88,37 €	1	5
MXCU000FLCNE					



Miscelatore cucina canna flessibile e girevole colore bianco
MXCU000FLCBI

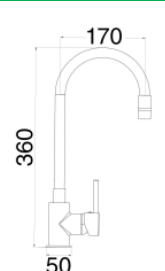

Codice	Riferimenti	Listino A	Listino B	Off.	Box
MXCU000FLCBI		79,61 €	88,37 €	1	5
MXCU000FLCBI					



Miscelatore cucina canna flessibile e girevole colore grigio
MXCU000FLCAG

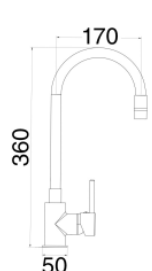

Codice	Riferimenti	Listino A	Listino B	Off.	Box
MXCU000FLCAG		79,61 €	88,37 €	1	5
MXCU000FLCAG					



Miscelatore cucina canna flessibile e girevole colore arancione
MXCU000FLCAR

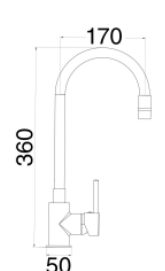

Codice	Riferimenti	Listino A	Listino B	Off.	Box
MXCU000FLCAR		79,61 €	88,37 €	1	5
MXCU000FLCAR					

Miscelatore cucina
canna flessibile e
girevole colore blu
MXCU000FLCBL



by GAY
rubinetterie

Codice	Riferimenti	Listino A	Listino B	Off.	Box
MXCU000FLCBL		79,61 €	88,37 €	1	5

MXCU000FLCBL

Miscelatore cucina
canna flessibile e
girevole colore giallo
MXCU000FLCGL





by GAY
rubinetterie

Codice	Riferimenti	Listino A	Listino B	Off.	Box
MXCU000FLCGL		79,61 €	88,37 €	1	5

MXCU000FLCGL

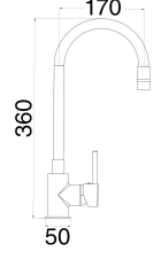
Miscelatore cucina
canna flessibile e
girevole colore rosso
MXCU000FLCRO





by GAY
rubinetterie

Codice	Riferimenti	Listino A	Listino B	Off.	Box
MXCU000FLCRO		79,61 €	88,37 €	1	5

MXCU000FLCRO

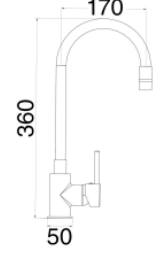
Miscelatore cucina
canna flessibile e
girevole colore verde
MXCU000FLCVE





by GAY
rubinetterie

Codice	Riferimenti	Listino A	Listino B	Off.	Box
MXCU000FLCVE		79,61 €	88,37 €	1	5

MXCU000FLCVE

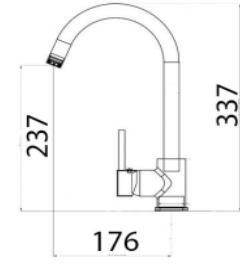
Miscelatore lavello
canna alta completo
di
flessibili
MXCGMCMCCR

by GAY
rubinetterie

Codice	Riferimenti	Listino A	Listino B	Off.	Box
MXCGMCMCCR		57,61 €	63,95 €	1	5

MXCGMCMCCR

Mix Lav. Mon. Mix/62
Sf Cr C/Canna
Reclinabile Sottofin.
MIX62SF00





ARMANDO VICARIO

Codice	Riferimenti	Listino A	Listino B	Off.	Box
MIX62SF00		137,24 €	152,33 €	1	5

MIX62SF00

Mix Lav. Mon. Liberty
Cromo Con Bocca
Girevole Mm. 260
7695CR

FARIS®
BUGATTI
SANITARY-TAPS

Codice	Riferimenti	Listino A	Listino B	Off.	Box
7695CR		89,64 €	99,51 €	1	5

7695CR

Mix Lav. Mon. Liberty
Bronzo Con Bocca
Girevole Mm. 260
7695VO





FARIS®
BUGATTI
SANITARY-TAPS

Codice	Riferimenti	Listino A	Listino B	Off.	Box
7695VO		139,03 €	154,33 €	1	5

7695VO

Mix Lav. Mon. Luxor
Cromo Con Bocca
Girevole Mm. 302
0170CR



FARIS®
BUGATTI
SANITARY-TAPS

Codice	Riferimenti	Listino A	Listino B	Off.	Box
0170CR		265,32 €	294,50 €	1	5

0170CR

Mix Lav. Mon.
Quadric Cromo Con
Bocca Girevole Mm.
320 16720CR



FARIS®
BUGATTI
SANITARY-TAPS

Codice	Riferimenti	Listino A	Listino B	Off.	Box
16720CR		178,40 €	198,03 €	1	5

16720CR



Mix Lav. Mon. Mix/54 Cromo
Canna A Ponte

ARMANDO
VICARIO

Codice	Riferimenti	Listino A	Listino B	Off.	Box
MIX5400		91,30 €	101,34 €	1	5
MIX5400x5	Offertax5	86,03 €	95,49 €	5	5
MIX5400x10	Offertax10	82,52 €	91,60 €	10	5
MIX5400x15	Offertax15	79,01 €	87,70 €	15	5



Mix Lavello Mon.
Lake Cromo Con
Bocca Girevole Fusa
Mm.318 0175CR

SERIE LAKE

FARIS®
BUGATTI
SANITARY-TAPS

Codice	Riferimenti	Listino A	Listino B	Off.	Box
0175CR		169,25 €	187,87 €	1	5
0175CR					



Mix Lav. Fo-20-Re Cromo Leva Chiusa FO20RE

ARMANDO
VICARIO

Codice	Riferimenti	Listino A	Listino B	Off.	Box
FO20RE		43,01 €	47,74 €	1	5
FO20RE					



Mix Lav. 110 Cromo Leva Aperta 110FMIX

ARMANDO
VICARIO

Codice	Riferimenti	Listino A	Listino B	Off.	Box
110FMIX		43,01 €	47,74 €	1	5
110FMIX					



Mix Lavello Mon.
Debora Canna Bassa
Attacco Lavatrice



Codice	Riferimenti	Listino A	Listino B	Off.	Box
AA609CR10LZ		72,92 €	80,94 €	1	6
AA609CR10LZ					



Mix Lavello Mon.
Diretta Debora
Canna Bassa

ARMANDO
VICARIO

Codice	Riferimenti	Listino A	Listino B	Off.	Box
MLMDDE00		83,13 €	92,28 €	1	6
MLMDDE00					



Mix Debora Lav. Mon. C /Bassa
MLMDE00

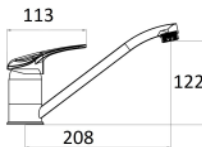

by
rubinetterie GAY

Codice	Riferimenti	Listino A	Listino B	Off.	Box
MLMDE00	Cromo	30,36 €	33,70 €	1	5
MXBMC7003CR					



Mix Lavello Parete Debora Cr.
MLPDE00

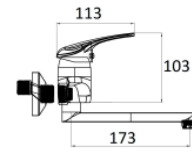

by
rubinetterie GAY

Codice	Riferimenti	Listino A	Listino B	Off.	Box
MLPDE00		42,51 €	47,18 €	1	5
MXBMC6003CR					



Mix Lavello Mon. Later. Debora
Canna Alta Pesante Cromo
MLMLDE00

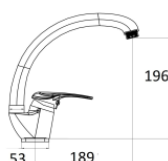

by
rubinetterie GAY

Codice	Riferimenti	Listino A	Listino B	Off.	Box
MLMLDE00		40,49 €	44,94 €	1	5
MXBMC5003CR					



Mix Lav. Mon. Doc /Estr. Debora
Cartuccia 40 MLMEDE00

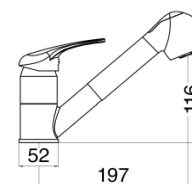

by
rubinetterie GAY

Codice	Riferimenti	Listino A	Listino B	Off.	Box
MLMEDE00	Cromo	106,27 €	117,96 €	1	5
MXBMC8003CR					

Mix Debora Lavello Monof.
Canna Alta Pes. Gran. Beige
MLMLDE85

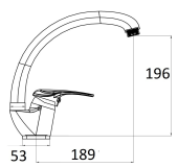

Codice	Riferimenti	Listino A	Listino B	Off.	Box
MLMLDE85	Avena	50,12 €	55,63 €	1	5
MLMLDE85					

Mix Lavello Mon. Lat. Debora
Bianco MLMLDE04

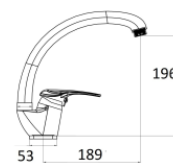

Codice	Riferimenti	Listino A	Listino B	Off.	Box
MLMLDE04		41,89 €	46,50 €	1	5
MLMLDE04					

Mix Elleci C01
Chrome MIKC01CR

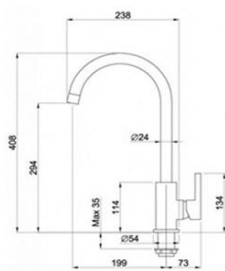

Codice	Riferimenti	Listino A	Listino B	Off.	Box
MIKC01CR		89,82 €	99,70 €	1	5
MIKC01CR					

Mix Elleci C01 Avena
51 MGKC0151

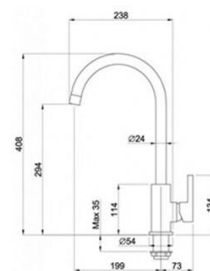

Codice	Riferimenti	Listino A	Listino B	Off.	Box
MGKC0151		92,35 €	102,51 €	1	5
MGKC0151					

Mix Elleci C01 Nero
40 MGKC0140

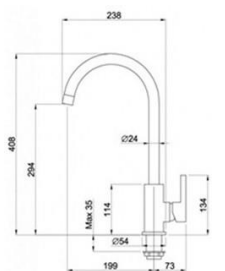

Codice	Riferimenti	Listino A	Listino B	Off.	Box
MGKC0140		92,35 €	102,51 €	1	5
MGKC0140					

Mix Elleci C01
Bianco 68
MGKC0168

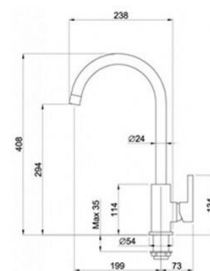

Codice	Riferimenti	Listino A	Listino B	Off.	Box
MGKC0168		92,35 €	102,51 €	1	5
MGKC0168					

Miscelatore Cucina
Con Doccetta
Estraibile Rubinetto
Monocomando Colore
Cromo MIKC02CR

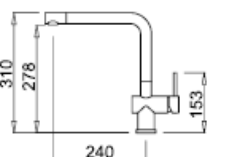

Codice	Riferimenti	Listino A	Listino B	Off.	Box
MIKC02CR		113,86 €	126,38 €	1	5
MIKC02CR					

Miscelatore Cucina
Con Doccetta
Estraibile Rubinetto
Monocomando
Materiale Granitek
Colore 51 Avena
MGKC0251

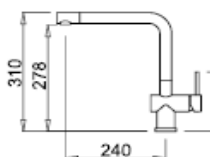

Codice	Riferimenti	Listino A	Listino B	Off.	Box
MGKC0251		118,92 €	132,00 €	1	5
MGKC0251					

Miscelatore Cucina
Con Doccetta
Estraibile Rubinetto
Monocomando Colore
Cromo Nero
MGKC0240

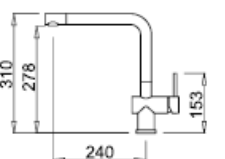

Codice	Riferimenti	Listino A	Listino B	Off.	Box
MGKC0240		118,92 €	132,00 €	1	5
MGKC0240					

Miscelatore Cucina
Con Doccetta
Estraibile Rubinetto
Monocomando Colore
Bianco
MGKC0268

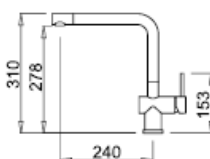

Codice	Riferimenti	Listino A	Listino B	Off.	Box
MGKC0268		118,92 €	132,00 €	1	5
MGKC0268					



Mix Lavabo Drewi Cartuccia 40 Completo Import



Codice	Riferimenti	Listino A	Listino B	Off.	Box
JH-8091	Cromo	38,34 €	42,56 €	1	6



Mix Bidet Drewi Cartuccia 40 Completo Import



Codice	Riferimenti	Listino A	Listino B	Off.	Box
JH-8099	Cromo	39,76 €	44,13 €	1	6



Mix Vasca Drewi Cartuccia 40 Completo Import



Codice	Riferimenti	Listino A	Listino B	Off.	Box
JH-8092	Cromo	35,50 €	39,41 €	1	6



Mix Lavello Cucina Drewi Cartuccia 40 Import



Codice	Riferimenti	Listino A	Listino B	Off.	Box
JH-8095D	Cromo	36,92 €	40,98 €	1	6



Miscelatore Lavello Canna Alta



Codice	Riferimenti	Listino A	Listino B	Off.	Box
JH-8065	Cromo	28,40 €	31,52 €	1	6



Mix Lavello Cucina Driwel Cartuccia 40 Import Zx



Codice	Riferimenti	Listino A	Listino B	Off.	Box
JH-8063	Cromo	34,08 €	37,83 €	1	6



Mix Lavello Cucina Drewi Cartuccia 40 Import Zx



Codice	Riferimenti	Listino A	Listino B	Off.	Box
JH-8095W	Cromo	34,08 €	37,83 €	1	6



Mix Lavello Cucina Inox Drewi Cartuccia 40 Import



Codice	Riferimenti	Listino A	Listino B	Off.	Box
S9008	Cromo	42,60 €	47,29 €	1	6



Mix Lavello Cucina Canna Alta Drewi Cartuccia 40 Avena Import



Codice	Riferimenti	Listino A	Listino B	Off.	Box
JH-8195D	Avena	36,92 €	40,98 €	1	12



Mix Lavello Cucina Driwel Cartuccia 40 Doccetta Estraibile Avena Import



Codice	Riferimenti	Listino A	Listino B	Off.	Box
JH-8816	Avena	56,39 €	62,59 €	1	12



Mix Lavello Cucina Drewi Cartuccia 40 Import



Codice	Riferimenti	Listino A	Listino B	Off.	Box
JH-1586	Cromo	26,98 €	29,95 €	1	12



Miscelatore Lavello Pietra Sabbia



Codice	Riferimenti	Listino A	Listino B	Off.	Box
JH-1585	Avena	42,60 €	47,29 €	1	12



Miscelatore canna Orientabile



Codice	Riferimenti	Listino A	Listino B	Off.	Box
814-1	NERO	38,34 €	42,56 €	1	12
814-2	BLUE	38,34 €	42,56 €	1	12
814-3	VERDE	38,34 €	42,56 €	1	12
814-4	ARANCIO	38,34 €	42,56 €	1	12
814-5	BIANCO	38,34 €	42,56 €	1	12
814-6	FUXIA	38,34 €	42,56 €	1	12



Mix Lav. Mon. Malibu' Q Cr

ARMANDO VICARIO

Codice	Riferimenti	Listino A	Listino B	Off.	Box
MALIBUQ00		39,69 €	44,06 €	1	5
MALIBUQ00x5	Offertax5	37,04 €	41,12 €	5	5
MALIBUQ00x10	Offertax10	35,28 €	39,16 €	10	5
MALIBUQ00x15	Offertax15	32,63 €	36,22 €	15	5



Miscelatore Cucina
Con Canna Alta
cartuccia 40 colore
Avena 52943



Codice	Riferimenti	Listino A	Listino B	Off.	Box
52943		41,62 €	46,20 €	1	5
52943					



Miscelatore Cucina
Con Canna Snodabile
Colore Cromo Canna
Nera 69410



Codice	Riferimenti	Listino A	Listino B	Off.	Box
69410		44,30 €	49,18 €	1	5
69410					



Mix Lavello Monoforo
"Debora" Canna Alta Fusa
Pesante

Hydro.Sat®

Codice	Riferimenti	Listino A	Listino B	Off.	Box
MLMLLDE00		110,22 €	122,35 €	1	5
MLMLLDE00x5	Offertax5	102,88 €	114,19 €	5	5
MLMLLDE00x10	Offertax10	97,98 €	108,76 €	10	5
MLMLLDE00x15	Offertax15	90,63 €	100,60 €	15	5



Monocomando
parrucchiere
"minimalista" con
cartuccia Ø 35 mm
flessibili di
alimentazione in
acciaio inox
70 cm. Flessibile in
PVC grigio
metallizzato 125 cm.

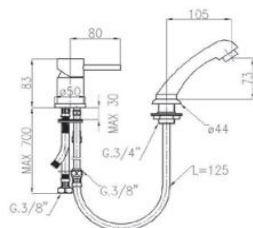

Codice	Riferimenti	Listino A	Listino B	Off.	Box
MP490-1000	Doccia Cromo	Arrivo	Arrivo	1	5
MP490-10	Doccia Nera	Arrivo	Arrivo	1	5



Mix Lav.Mon.Malibu' Due P
Cr

ARMANDO VICARIO

Codice	Riferimenti	Listino A	Listino B	Off.	Box
MALIBU2P00		39,69 €	44,06 €	1	5
MALIBU2P00x5	Offertax5	37,04 €	41,12 €	5	5
MALIBU2P00x10	Offertax10	35,28 €	39,16 €	10	5
MALIBU2P00x15	Offertax15	32,63 €	36,22 €	15	5



Miscelatore lavello
Monoforo Canna Alta
Avena 69146



Codice	Riferimenti	Listino A	Listino B	Off.	Box
69146		48,33 €	53,65 €	1	5
69146					



Miscelatore lavello
Monoforo Canna Alta
Bianco 79830



Codice	Riferimenti	Listino A	Listino B	Off.	Box
79830		51,02 €	56,63 €	1	5
79830					



Mix Lavello Monoforo
"Debora" Canna Alta Tubo
Ombrello

Hydro.Sat®

Codice	Riferimenti	Listino A	Listino B	Off.	Box
MLMLPDE00		73,48 €	81,57 €	1	5
MLMLPDE00x5	Offertax5	68,58 €	76,13 €	5	5
MLMLPDE00x10	Offertax10	65,32 €	72,50 €	10	5
MLMLPDE00x15	Offertax15	60,42 €	67,07 €	15	5



Miscelatore cucina per filtro d'acqua
potabile acciaio inox linea osmosi
52691

carily®



Codice	Riferimenti	Listino A	Listino B	Off.	Box
52691		94,19 €	104,55 €	1	5
52691					



Gruppo Lavello Parete Cromo
Francesca GLPF00



Cromato

Codice	Riferimenti	Listino A	Listino B	Off.	Box
GLPF00	Cromo	76,24 €	84,63 €	1	5
GLPF00					



Gruppo Lavello Mono.B/Antica
Francesca Cromo GLMAF00



Cromato

Codice	Riferimenti	Listino A	Listino B	Off.	Box
GLMAF00		103,09 €	114,43 €	1	5
GLMAF00					



Gruppo Lavello monoforo Maniglia
Tiziana Cromo Doccetta



Cromato

Codice	Riferimenti	Listino A	Listino B	Off.	Box
GLMETB	Doccia Bianca	46,48 €	51,60 €	1	5
GLMETN	Doccia Nera	46,48 €	51,60 €	1	5

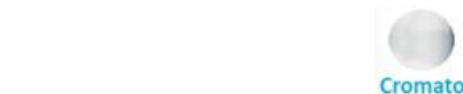

Cromato

Codice	Riferimenti	Listino A	Listino B	Off.	Box
0		Arrivo	Arrivo	1	5



Gruppo Lavello Mon. C/Lusso
Pesante Alta Tiziana GLMFAT



Cromato

Codice	Riferimenti	Listino A	Listino B	Off.	Box
GLMFAT	Cromo	39,14 €	43,45 €	1	5
GLMFAT					



Gruppo Lavello Mon. C/Fusa Tiziana
GLMFT



Cromato

Codice	Riferimenti	Listino A	Listino B	Off.	Box
GLMFT		46,46 €	51,57 €	1	5
GLMFT					



Gruppo Lavello Monoforo Jota
GLMJT00



Cromato

Codice	Riferimenti	Listino A	Listino B	Off.	Box
GLMJT00		44,82 €	49,75 €	1	5
GLMJT00					



Rubinetto Colonna Bar Tiziana
RCBT



Cromato

Codice	Riferimenti	Listino A	Listino B	Off.	Box
RCBT		24,54 €	27,24 €	1	5
RCBT					



Rubinetto Rov. C/Snodo "U" Tiziana
1/2" RRUT



Cromato



Codice	Riferimenti	Listino A	Listino B	Off.	Box
RRUT		24,04 €	26,68 €	1	5
RRUT					



Rubinetto A Snodo Tiziana RRT



Cromato



Codice	Riferimenti	Listino A	Listino B	Off.	Box
RRT		24,04 €	26,68 €	1	5
RRT					

Gruppo Lavello Parete Attacco Lavatrice Canna "U" GLPLUT



FARIS®

Codice	Riferimenti	Listino A	Listino B	Off.	Box
GLPLUT	Cromo	63,25 €	70,21 €	1	5

GLPLUT

Gruppo Lavello Pareteattacco Lavatrice Canna "E" GLPLT



FARIS®

Codice	Riferimenti	Listino A	Listino B	Off.	Box
GLPLT	Cromo	63,25 €	70,21 €	1	5

GLPLT

Gruppo Lavello Parete Canna U Tizian GLPTU



FARIS®

Codice	Riferimenti	Listino A	Listino B	Off.	Box
GLPTU		40,48 €	44,94 €	1	5

GLPTU

Gruppo Lavello Parete Tiziana GLPT



FARIS®

Codice	Riferimenti	Listino A	Listino B	Off.	Box
GLPT		42,51 €	47,18 €	1	5

GLPT

Rubinetto Snodo + Lav. Tiziana RRBTE



FARIS®

Codice	Riferimenti	Listino A	Listino B	Off.	Box
RRBTE		26,39 €	29,29 €	1	5

RRBTE

Rubinetto Sq. Lav. 1/2" X 3/4" Angolo Orientale RLAOV00



FARIS®

Codice	Riferimenti	Listino A	Listino B	Off.	Box
RLAOV00		4,85 €	5,38 €	1	6
RLAOV00x6	Offertax6	4,59 €	5,10 €	6	6

Coppia Retrogruppo X Lav. 3/4" CRL3/4



FARIS®

Codice	Riferimenti	Listino A	Listino B	Off.	Box
CRL3/4		9,31 €	10,33 €	1	6
CRL3/4x6	Offertax6			6	6

CRL3/4x6

Copp. Distanz. Ott. Crom. 3/4X3/4 Con E Senza Foro 3/8 Mf CDF00



FARIS®

Codice	Riferimenti	Listino A	Listino B	Off.	Box
CDF00		4,36 €	4,84 €	1	6
CDF00x6	Offertax6	4,13 €	4,59 €	6	6

CDF00x6

Retrogruppo C/Ghiera Girev. RGG



FARIS®

Codice	Riferimenti	Listino A	Listino B	Off.	Box
RGG		10,18 €	11,30 €	1	6
RGGx6	Offertax6	9,64 €	10,71 €	6	6

RGGx6

Coppia Distanz Ottone Cromato Dado Girevole Con E Senz Foro CDDG00



FARIS®

Codice	Riferimenti	Listino A	Listino B	Off.	Box
CDDG00		7,56 €	8,39 €	1	6
CDDG00x6	Offertax6	7,16 €	7,95 €	6	6

CDDG00x6



Rubinetto Biuso 1/2" Tiziana
Ec Rbe00 RBTE

Codice	Riferimenti	Listino A	Listino B	Off.	Box
RBTE		12,34 €	13,70 €	1	12
RBTEx12	Offertax12	11,69 €	12,98 €	12	12



Rubinetto Biuso 1/2" Tiziana
P. RBPT

Codice	Riferimenti	Listino A	Listino B	Off.	Box
RBPT		20,82 €	23,11 €	1	10
RBPTx10	Offertax10	19,72 €	21,89 €	10	10



Rubinetto Full 1/2" Marziano
RF1\2

Codice	Riferimenti	Listino A	Listino B	Off.	Box
RF1\2		10,52 €	11,68 €	1	12
RF1\2x12	Offertax12	9,97 €	11,06 €	12	12



Rubinetto Sing.C/Aeratore
1/2" RAT

Codice	Riferimenti	Listino A	Listino B	Off.	Box
RAT		21,55 €	23,92 €	1	10
RATx10	Offertax10	20,41 €	22,66 €	10	10



Rubinetto Ful 1/2" Port.
Marz. RF1\2P

Codice	Riferimenti	Listino A	Listino B	Off.	Box
RF1\2P		13,08 €	14,52 €	1	12
RF1\2Px12	Offertax12	12,34 €	13,70 €	12	12



Rubinetto Singolo 1/2" S/P
Tiz. RT

Codice	Riferimenti	Listino A	Listino B	Off.	Pz
RT		19,17 €	21,28 €	1	10
RTx10	Offertax10	18,16 €	20,16 €	10	10



Rubinetto 1/2 C/Vitone
Rapido 1/4 Di Giro Leva 669

Codice	Riferimenti	Listino A	Listino B	Off.	Box
669		11,58 €	12,85 €	1	6
669x6	Offertax6	10,97 €	12,18 €	6	6



Rubinetto Vitone Rapido D.
1/2" Cromato Idral Leva
Pesante In Ottone RVRLC1\2

Codice	Riferimenti	Listino A	Listino B	Off.	Box
RVRLC1\2		15,76 €	17,49 €	1	6
RVRLC1\2x6	Offertax6	14,93 €	16,57 €	6	6



Rubinetto Diritto Da 1/2 Con
Rompigetto Cromo 667

Codice	Riferimenti	Listino A	Listino B	Off.	Box
667		11,85 €	13,15 €	1	6
667x10	Offertax10	11,23 €	12,46 €	10	6



Rubinetto Biuso Lav+Lav A Y
RBLYT

Codice	Riferimenti	Listino A	Listino B	Off.	Box
RBLYT		26,40 €	29,30 €	1	5
RBLYTx5	Offertax5	24,87 €	27,61 €	5	5



Gruppetto Sottoboiler 1/2"
Cromo GSTE

Codice	Riferimenti	Listino A	Listino B	Off.	Box
GSTE		55,61 €	61,73 €	1	6
GSTEx6	Offertax6	52,68 €	58,48 €	6	6



Miscelatore per scaldabagno
attacco F

Codice	Riferimenti	Listino A	Listino B	Off.	Box
0023MIX		67,38 €	74,80 €	1	5
0023MIXx5	Offertax5	63,50 €	70,48 €	5	5

Rubinetto Artistico 1/2"
Vitone RA1\2V



Codice	Riferimenti	Listino A	Listino B	Off.	Box
RA1\2V		27,58 €	30,61 €	1	6
RA1\2Vx6	Offertax6	26,59 €	29,51 €	6	6

Rubinetto Pulsante Fontana
RPFGL



Codice	Riferimenti	Listino A	Listino B	Off.	Box
RPFGL		22,76 €	25,26 €	1	6
RPFGLx6	Offertax6	21,44 €	23,80 €	6	6

Rubinetto A Sfera 1/2" P
/Lucch. RS1\2L



Codice	Riferimenti	Listino A	Listino B	Off.	Box
RS1\2L	1/2"	7,53 €	8,36 €	1	1
RS3\4L	3/4"	8,90 €	9,88 €	1	1

Rubinetto Sfera Pes. Leva
1/2" Blu RS1\2P



Codice	Riferimenti	Listino A	Listino B	Off.	Box
RS1\2P	1/2"	9,60 €	10,65 €	1	1
RS3\4P	3/4"	12,60 €	13,98 €	1	1

Rubinetto A Sfera Da 1/2"
RS1\2



Codice	Riferimenti	Listino A	Listino B	Off.	Box
RS1\2	1/2"	5,21 €	5,78 €	1	1
RS3\4	3/4"	8,19 €	9,10 €	1	1
RS1	1"	13,85 €	15,37 €	1	1

Rubinetto A Sfera Doppio
Portagomma 2040ST015



Codice	Riferimenti	Listino A	Listino B	Off.	Box
2040ST015	1/2"	12,83 €	14,24 €	1	1

Rubinetto Artistico 1/2" Sfera
RA1\2S



Codice	Riferimenti	Listino A	Listino B	Off.	Box
RA1\2S		26,82 €	29,77 €	1	6
RA1\2Sx6	Offertax6	25,86 €	28,70 €	6	6

RGP1\2

Rubinetto G. Da 1/2" Lucido
CON PORTAGOMMA RGP1\2



RG1\2

Rubinetto G. Da 1/2"
Lucido RG1\2



Codice	Riferimenti	Listino A	Listino B	Off.	Box
RGP1\2	1/2"	17,56 €	19,49 €	1	5
RG1\2	1/2"	12,11 €	13,45 €	1	5

Rubinetto Giallo C /Estr. Port.
RGCE1\2



Codice	Riferimenti	Listino A	Listino B	Off.	Box
RGCE1\2	1/2"	8,90 €	9,88 €	1	1
RGCE1\2x10	Offertax10	8,17 €	9,07 €	10	10

Rubinetto Sfera Pes. 1/2"
Leva Alluminio Nera
2050N015



Codice	Riferimenti	Listino A	Listino B	Off.	Box
2050N015	1/2"	8,24 €	9,15 €	1	1

Rubinetto A Sfera
C/Portagomma Asta Piatta
1/2" 2060ST015



Codice	Riferimenti	Listino A	Listino B	Off.	Box
2060ST015	1/2"	5,76 €	6,39 €	1	1
2060ST020	3/4"	8,13 €	9,02 €	1	1
2060ST025	1"	14,08 €	15,63 €	1	1

Rubinetto Sfera Lavatrice
Bibo RSLB



Codice	Riferimenti	Listino A	Listino B	Off.	Box
RSLB		7,93 €	8,80 €	1	10
RSLBx10	Offertax10	7,51 €	8,34 €	10	10



Rubinetto Sfera Lavatrice Pes.
RSLP

Codice	Riferimenti	Listino A	Listino B	Off.	Box
RSLP		6,70 €	7,43 €	1	10
RSLPx10	Offertax10	6,34 €	7,04 €	10	10



Rubinetto Sfera Lavatrice D.
1/2"X3(4) RSL

Codice	Riferimenti	Listino A	Listino B	Off.	Box
RSL		5,99 €	6,64 €	1	10
RSLx10	Offertax10	5,39 €	5,98 €	10	10



Vitone Ricambio Da 3/8" H. 20 V3\8



Vitone Universale Da 1/2" V1\2

Codice	Riferimenti	Listino A	Listino B	Off.	Box
V3\8	D. 3/8"	1,66 €	1,84 €	1	10
V1\2	D. 1/2"	2,88 €	3,20 €	10	10



Vitone Ricambio 18/19 V18\19

Codice	Riferimenti	Listino A	Listino B	Off.	Box
V19\19	19/19	7,25 €	8,05 €	1	10
V18\19	18/19	5,92 €	6,58 €	10	10



Vitone Ceramico 90° 1/2"
Freddo V1\2C90F



Vitone 1/2" Doppio Filetto
V1\2D

Codice	Riferimenti	Listino A	Listino B	Off.	Box
V1\2C90F	Freddo	6,89 €	7,65 €	1	10
V1\2C90C	Caldo	6,89 €	7,65 €	10	10

Codice	Riferimenti	Listino A	Listino B	Off.	Box
V1\2D	D. 1/2"	3,44 €	3,82 €	1	10
V1\2Dx10	Offertax10	3,28 €	3,64 €	10	10



Maniglia Ottone
Crom.Rub.Calda MRTC



Maniglia
Ottonecrom.Rub.Freddo
MRTF

Codice	Riferimenti	Listino A	Listino B	Off.	Box
MRTC	CALDA	4,08 €	4,53 €	1	10
MRTCx10	Offertax10	3,88 €	4,31 €	10	10

Codice	Riferimenti	Listino A	Listino B	Off.	Box
MRTF	FREDDA	4,08 €	4,53 €	1	10
MRTFx10	Offertax10	3,88 €	4,31 €	10	10



Snodino Semplice In Ottone
Cr. SSO



Snodino Nylon Econ. SNE

Codice	Riferimenti	Listino A	Listino B	Off.	Box
SSO	Cromo	0,76 €	0,84 €	1	10
SSOx10	Offertax10	0,73 €	0,81 €	10	10

Codice	Riferimenti	Listino A	Listino B	Off.	Box
SNE	Nylon	0,26 €	0,28 €	1	10
SNEx10	Offertax10	0,22 €	0,24 €	10	10



Snodino Doppio In Ottone Cr.
SDO



Cartuccia Nicolazzi C3009

Codice	Riferimenti	Listino A	Listino B	Off.	Box
SDO	Cromo	2,02 €	2,24 €	1	10
SDOx10	Offertax10	1,94 €	2,16 €	10	10

Codice	Riferimenti	Listino A	Listino B	Off.	Box
C3009		70,88 €	78,67 €	1	5
C3009x5	Offertax5	63,25 €	70,21 €	5	10

Cartuccia Da 25 Alta CM25A



Codice	Riferimenti	Listino A	Listino B	Off.	Box
CM25A	D. 25	3,56 €	3,95 €	1	10
CM25Ax10	Offertax10	3,42 €	3,79 €	10	10

Cartuccia Alta Da 35 C35A



Codice	Riferimenti	Listino A	Listino B	Off.	Box
C35A	D. 35	3,39 €	3,76 €	1	10
C35Ax10	Offertax10	3,25 €	3,61 €	10	10

Cartuccia Da 40 Alta C40A



Codice	Riferimenti	Listino A	Listino B	Off.	Box
C40A	D. 40	3,39 €	3,76 €	1	10
C40Ax10	Offertax10	3,25 €	3,61 €	10	10

Set Fissaggio Mix C. 40 2 Bul.
HY-228A



Codice	Riferimenti	Listino A	Listino B	Off.	Box
HY-228A		1,94 €	2,15 €	1	10
HY-228Ax10	Offertax10	1,82 €	2,02 €	10	10

Set Fissaggio Mix C. 40 1 Bul.
HY-228



Codice	Riferimenti	Listino A	Listino B	Off.	Box
HY-228		1,67 €	1,85 €	1	10
HY-228x10	Offertax10	1,57 €	1,74 €	10	10

Basetta Appoggio Abs Cromo
BAD00



Codice	Riferimenti	Listino A	Listino B	Off.	Box
BAD00		0,76 €	0,84 €	1	10
BAD00x10	Offertax10	0,73 €	0,81 €	10	10

Cartuccia Da 25 Bassa
CM25B



Codice	Riferimenti	Listino A	Listino B	Off.	Box
CM25B	D. 25	3,56 €	3,95 €	1	10
CM25Bx10	Offertax10	3,42 €	3,79 €	10	10

Cartuccia Bassa Da 35 C35B



Codice	Riferimenti	Listino A	Listino B	Off.	Box
C35B	D. 35	3,39 €	3,76 €	1	10
C35Bx10	Offertax10	3,25 €	3,61 €	10	10

Cartuccia Da 40 Bassa C40B



Codice	Riferimenti	Listino A	Listino B	Off.	Box
C40B	D. 40	3,39 €	3,76 €	1	10
C40Bx10	Offertax10	3,25 €	3,61 €	10	10

Rubinetto Squadra 1/2" F -
1/2" M C-Codulo 3/8" M
RSCWCD



Codice	Riferimenti	Listino A	Listino B	Off.	Box
RSCWCD	1	7,09 €	7,87 €	5	10
RSCWCDX5	X5	6,71 €	7,45 €	5	10
RSCWCDX10	X10	6,38 €	7,08 €	5	10
RSCWCDX15	X15	6,04 €	6,71 €	5	10

Kit Rubinetto Sq.1/2"X10
Bronzo KCRDC47



Codice	Riferimenti	Listino A	Listino B	Off.	Box
KCRDC47		34,90 €	38,74 €	1	10
KCRDC47x10	Offertax10	33,20 €	36,85 €	10	10

Riduzione M22X1 3/4 Ott
Cromato 1350050894



Codice	Riferimenti	Listino A	Listino B	Off.	Box
1350050894		7,22 €	8,02 €	1	10



Riduzione Per Aeratore F.22 X
1/2 M. "Xx" RDF22M12

Codice	Riferimenti	Listino A	Listino B	Off.	Box
RDF22M12		1,32 €	1,46 €	1	10



Riduzione 1/2Xm22X1 Ott
Cromato 1350092094

Codice	Riferimenti	Listino A	Listino B	Off.	Box
1350092094		3,65 €	4,05 €	1	10



Riduzione 3/4Fxm22X1 Ott
Cromato "Xx" 1350092594

Codice	Riferimenti	Listino A	Listino B	Off.	Box
1350092594		1,75 €	1,94 €	1	10



Riduzione M22X1 3/4 Ott
Cromato 1350050894

Codice	Riferimenti	Listino A	Listino B	Off.	Box
1350050894		7,22 €	8,02 €	1	10



Riduzione M22X1 X M24X1
Ottone Nichelato
1350050394

Codice	Riferimenti	Listino A	Listino B	Off.	Box
1350050394		2,45 €	2,72 €	1	10



Riduzione 3/4Mxm24X1 Ott
Cromato "Xx" 1350051094

Codice	Riferimenti	Listino A	Listino B	Off.	Box
1350051094		2,45 €	2,72 €	1	10



Riduzione In Ottone Cromata
24/1Mx1/2"M "Xx" 140/R1

Codice	Riferimenti	Listino A	Listino B	Off.	Box
140/R1		1,39 €	1,54 €	1	10



Bocca Di Erogazione A Parete
Attacco 3/4" Con Deviatore
1/2" BEPDG00

Codice	Riferimenti	Listino A	Listino B	Off.	Box
BEPDG00		76,20 €	84,59 €	1	6
BEPDG00x6	Offertax6	69,90 €	77,59 €	6	12



Bocca Di Erogazione Parete
3/4" BEPG00

Codice	Riferimenti	Listino A	Listino B	Off.	Box
BEPG00		57,15 €	63,44 €	1	6
BEPG00x6	Offertax6	55,11 €	61,17 €	6	12



Colonnina Bordo Vasca
Cromo CBV00

Codice	Riferimenti	Listino A	Listino B	Off.	Box
CBV00		5,74 €	6,37 €	1	10



Colonnina Bordo Vasca Fissa
CBVF00

Codice	Riferimenti	Listino A	Listino B	Off.	Box
CBVF00		4,82 €	5,35 €	1	10



Eccentrico Per Gruppo
cromato con rosetta

Codice	Riferimenti	Listino A	Listino B	Off.	Box
EGU4	CM. 4	8,02 €	8,90 €	1	10
EGU6	CM. 6	4,59 €	5,10 €	1	10
EGU8	CM. 8	Arrivo	Arrivo	1	10



Eccentrico X Gruppo Univ.
Crom EGU

Codice	Riferimenti	Listino A	Listino B	Off.	Box
EGU		2,30 €	2,55 €	1	10



Riduzione Per Aeratore F.22 X
3/4 M. "Xx" RDF22M34

Codice	Riferimenti	Listino A	Listino B	Off.	Box
RDF22M34		2,07 €	2,30 €	1	10



Snodo Con Aeratore Per Bidet Vedi Anche Il Codice Aerocsf22 ASBF

Codice	Riferimenti	Listino A	Listino B	Off.	Box
ASBF		3,81 €	4,23 €	1	10



Aeratore Af22 Ottone Cr F 22 Xx Vedi Anche Il Codice Af22 "Xx" AEREXF22

Codice	Riferimenti	Listino A	Listino B	Off.	Box
AEREXF22		0,38 €	0,42 €	1	10



Aeratore Am28 Cromo M.28X1 Vedia Nche Il Codice Am28 AEREXM28

Codice	Riferimenti	Listino A	Listino B	Off.	Box
AEREXM28		0,70 €	0,77 €	1	10



Rompigetto per lavello Risparmio Acqua 69274

Codice	Riferimenti	Listino A	Listino B	Off.	Box
69274		3,78 €	4,20 €	1	10



ROmpigetto perLavello Risparmio acqua adattabile 22 femmina 24 maschio 69265

Codice	Riferimenti	Listino A	Listino B	Off.	Box
69265		1,89 €	2,10 €	1	10



ROmpigetto perLavello Risparmio acqua bloccabile nella canna erogazione 69264

Codice	Riferimenti	Listino A	Listino B	Off.	Box
69264		1,89 €	2,10 €	1	10



Aeratore Prolungato 22X1F Bianco APFB

Codice	Riferimenti	Listino A	Listino B	Off.	Box
APFB		1,99 €	2,21 €	1	10



Aeratore Maschio Snodo Bidetzz ASBM

Codice	Riferimenti	Listino A	Listino B	Off.	Box
ASBM		2,82 €	3,13 €	1	10



Aeratore Cromo M. 22X1 Xx Vedi Anche Il Codice Am22 "Xx" AEREXM22

Codice	Riferimenti	Listino A	Listino B	Off.	Box
AEREXM24	24	0,46 €	0,51 €	1	10
AEREXM22	22	0,30 €	0,34 €	1	10



Guarnizione per Aeratore M24 pz 12 69382

Codice	Riferimenti	Listino A	Listino B	Off.	Box
69382		1,51 €	1,68 €	1	10



Rompigetto Rubinetto, Aeratore Rubinetto, Aeratori per Rubinetti, per la Sostituzione Della Testa del

Codice	Riferimenti	Listino A	Listino B	Off.	Box
LM98734		16,38 €	18,18 €	1	10



ROmpigetto perLavello Risparmio acqua adattabile 22 femmina 24 maschio 69269

Codice	Riferimenti	Listino A	Listino B	Off.	Box
69269		2,02 €	2,24 €	1	10



Aeratore Prolungato 22X1F con 2 getti Cromo APFRCR

Codice	Riferimenti	Listino A	Listino B	Off.	Box
APFRCR		5,60 €	6,21 €	1	10



Aeratore Prolungato 22X1F Cromo APFCR

Codice	Riferimenti	Listino A	Listino B	Off.	Box
APFCR		3,97 €	4,41 €	1	10

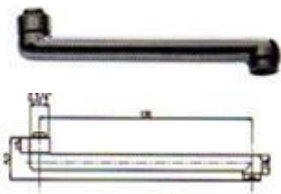

Bocca Erogazione a biscotto pesante

Codice	Riferimenti	Listino A	Listino B	Off.	Box
BOMC12	Cromo CM. 12	16,07 €	17,84 €	1	12
BOMC15	Cromo CM. 15	7,96 €	8,84 €	1	12
BOMC20	Cromo CM. 20	16,53 €	18,35 €	1	12
BOMC25	Cromo CM. 25	17,08 €	18,96 €	1	12
BOMC20E	cm 20 EXPO	14,15 €	15,70 €	1	12



Bocca Girevole Tubo
Sagomato Dado 3/4" Pesante
HY-263G

Import Export

Codice	Riferimenti	Listino A	Listino B	Off.	Box
HY-263G		19,39 €	21,52 €	1	12
HY-263Gx6	Offertax6	18,37 €	20,39 €	6	12



Bocca Girevole Fusa Pesante
HY-266G

Codice	Riferimenti	Listino A	Listino B	Off.	Box
HY-266G		25,21 €	27,98 €	1	12
HY-266Gx6	Offertax6	23,88 €	26,51 €	6	12



Canna Alta Ombrello D.24 H
280X230 HY-G2402

Codice	Riferimenti	Listino A	Listino B	Off.	Box
HY-G2402		13,92 €	15,45 €	1	12
HY-G2402x6	Offertax6	11,29 €	12,53 €	6	12



Canna Alta A Tubo Per
Lavabo Da Mm Da 230X190
Mm Girevole HY-G2403

Codice	Riferimenti	Listino A	Listino B	Off.	Box
HY-G2403		12,66 €	14,05 €	1	12
HY-G2403x6	Offertax6	10,79 €	11,98 €	6	12



Canna Alta A Tubo Per
Lavabo Da Mm Da 220X170
Mm Girevole HY-G2404

Codice	Riferimenti	Listino A	Listino B	Off.	Box
HY-G2404		10,05 €	11,16 €	1	12
HY-G2404x6	Offertax6	8,15 €	9,05 €	6	12



Canna Univ. Jota 3/4"X20
CJU20

Codice	Riferimenti	Listino A	Listino B	Off.	Box
CJU20		7,38 €	8,19 €	1	12
CJU20x6	Offertax6	6,29 €	6,98 €	6	12



Canna Telescopica D. 18 Est.
Da 200 A 300 Mm I-09500SE

Codice	Riferimenti	Listino A	Listino B	Off.	Box
I-09500SE		30,00 €	33,30 €	1	12
I-09500SEx6	Offertax6	24,33 €	27,01 €	6	12



Canna Universale Cm. 20 Con
Bocca Orientabile CBR20

Codice	Riferimenti	Listino A	Listino B	Off.	Box
CBR20		6,34 €	7,04 €	1	12
CBR20x6	Offertax6	5,41 €	6,00 €	6	12



Canna Lav. Univ."U"Cr 18X20
CUU20

Codice	Riferimenti	Listino A	Listino B	Off.	Box
CUU20		6,44 €	7,15 €	1	12
CUU20x6	Offertax6	6,18 €	6,86 €	6	12



Canna Univ. A Esse
3/4" X 20Cm. CUE20

Codice	Riferimenti	Listino A	Listino B	Off.	Box
CUE20		5,85 €	6,49 €	1	12
CUE20x6	Offertax6	5,61 €	6,23 €	6	12



Flussometro Inc. Da 3/4" Cr.
F3\400



Codice	Riferimenti	Listino A	Listino B	Off.	Box
F3\400	D. 3/4"	51,92 €	57,63 €	1	10
F100	D. 1"	44,46 €	49,35 €	1	10



Piastra Passo Rapido In Ottone Cromato H10X28 Mm 87X135



Codice	Riferimenti	Listino A	Listino B	Off.	Box
2912F04		3,71 €	4,11 €	1	10
2912F04x5	Offertax5	3,51 €	3,90 €	5	10
2912F04x10	Offertax10	3,34 €	3,70 €	10	10
2912F04x15	Offertax15	3,16 €	3,51 €	15	10



Placca Inox Per Flussometro PIF

Codice	Riferimenti	Listino A	Listino B	Off.	Box
PIF	Inox	0,92 €	1,02 €	1	10
PIFx5	Offertax5	0,87 €	0,96 €	5	10
PIFx10	Offertax10	0,82 €	0,91 €	10	10
PIFx15	Offertax15	0,78 €	0,87 €	15	10



Blister Vitoni Rubinetto 090BVU

Codice	Riferimenti	Listino A	Listino B	Off.	Box
090BVU		9,28 €	10,30 €	1	5
090BVUx5	Offertax5	8,79 €	9,76 €	5	5
090BVUx10	Offertax10	8,35 €	9,27 €	10	5
090BVUx15	Offertax15	7,91 €	8,78 €	15	5



Valvola Per Vitone Flussometro

Codice	Riferimenti	Listino A	Listino B	Off.	Box
VFH40	h. 40	2,78 €	3,09 €	1	10
VFH50	h. 50	2,78 €	3,09 €	1	10
VFH60	h. 60	2,78 €	3,09 €	1	10



Tubo Telescopico Flussometro Esterno Da 3/4" D. 25 Cromo TTF3\4E00

Codice	Riferimenti	Listino A	Listino B	Off.	Box
TTF3\4E00	D. 3/4"	18,37 €	20,39 €	1	5
TTF1E00	D. 1"	36,96 €	41,03 €	1	5



Flussometro Esterno 3/4" Cr.
FE3\400



Codice	Riferimenti	Listino A	Listino B	Off.	Box
FE3\400	D. 3/4"	39,55 €	43,90 €	1	10
FE100	D. 1"	47,05 €	52,23 €	1	10

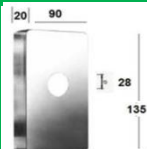

Piastra Passo Rapido In Ottone Cromato H20X28 Mm 87X135



Codice	Riferimenti	Listino A	Listino B	Off.	Box
2912F07		4,52 €	5,02 €	1	10
2912F07x5	Offertax5	4,29 €	4,76 €	5	10
2912F07x10	Offertax10	4,07 €	4,52 €	10	10
2912F07x15	Offertax15	4,07 €	4,52 €	15	10



Rosone X Fluss. Tondo 20X25 RFT20X25



Codice	Riferimenti	Listino A	Listino B	Off.	Box
RFT20X25		2,26 €	2,51 €	1	10
RFT20X25x5	Offertax5	2,22 €	2,47 €	5	10
RFT20X25x10	Offertax10	2,18 €	2,41 €	10	10
RFT20X25x15	Offertax15	2,08 €	2,31 €	15	10



Blister Vitoni Flussometri 091BUF

Codice	Riferimenti	Listino A	Listino B	Off.	Box
091BUF		30,97 €	34,38 €	1	5
091BUFx5	Offertax5	29,34 €	32,57 €	5	5
091BUFx10	Offertax10	27,88 €	30,94 €	10	5
091BUFx15	Offertax15	26,41 €	29,31 €	15	5



Vitone Completo di maniglia+vite+boccola per flussometro

Codice	Riferimenti	Listino A	Listino B	Off.	Box
VF26H33	D. 26	25,06 €	27,81 €	1	10
VF27H33	D. 27	25,06 €	27,81 €	1	10
VF28H33	D. 28	25,06 €	27,81 €	1	10
VF29H33	D. 29	25,06 €	27,81 €	1	10
VF30H33	D. 30	26,72 €	29,66 €	1	10
VF32H33	D. 32	26,72 €	29,66 €	1	10



Piastra Prova Vitoni PPV

Codice	Riferimenti	Listino A	Listino B	Off.	Box
PPV	ottone	82,49 €	91,57 €	1	1

Flessibili Sanitari



**PRODOTTI
MADE IN ITALY**



Flex inox 7 fili dadi e cartelle in ottone 1/2" MF



Codice	Riferimenti	Listino A	Listino B	Box
FI20FF	1/2" FF CM 20	2,72 €	3,02 €	25
FI25FF	1/2" FF CM 25	2,95 €	3,28 €	25
FI30FF	1/2" FF CM 30	3,14 €	3,48 €	25
FI35FF	1/2" FF CM 35	3,37 €	3,74 €	25
FI40FF	1/2" FF CM 40	3,64 €	4,04 €	25
FI50FF	1/2" FF CM 50	4,06 €	4,50 €	25
FI60FF	1/2" FF CM 60	4,43 €	4,91 €	25
FI80FF	1/2" FF CM 80	5,35 €	5,94 €	25
FI100FF	1/2" FF CM 100	6,18 €	6,86 €	25

Flex inox 7 fili dadi e cartelle in ottone 1/2" MF



Codice	Riferimenti	Listino A	Listino B	Box
FI20	1/2" MF CM 20	2,46 €	2,73 €	25
FI25	1/2" MF CM 25	2,95 €	3,28 €	25
FI30	1/2" MF CM 30	3,20 €	3,55 €	25
FI35	1/2" MF CM 35	2,93 €	3,25 €	25
FI40	1/2" MF CM 40	2,94 €	3,26 €	25
FI50	1/2" MF CM 50	3,44 €	3,82 €	25
FI60	1/2" MF CM 60	4,43 €	4,91 €	25
FI80	1/2" MF CM 80	3,14 €	3,48 €	25
FI100	1/2" MF CM 100	3,49 €	3,88 €	25

Acciaio Inox 7 fili con raccordi: Maschio / Femmina Sede Piana
 Stainless steel braiding 7 wires · Fittings: Male x Female



Flex inox 7 fili dadi e cartelle in ottone 1/2"X3/8" MF



Codice	Riferimenti	Listino A	Listino B	Box
FI3\8X20	1/2"X3/8" MF CM 20	2,46 €	2,73 €	25
FI3\8X25	1/2"X3/8" MF CM 25	2,64 €	2,93 €	25
FI3\8X30	1/2"X3/8" MF CM 30	2,80 €	3,11 €	25
FI3\8X35	1/2"X3/8" MF CM 35	2,94 €	3,26 €	25
FI3\8X40	1/2"X3/8" MF CM 40	3,07 €	3,41 €	25
FI3\8X50	1/2"X3/8" MF CM 50	3,43 €	3,81 €	25
FI3\8X60	1/2"X3/8" MF CM 60	2,76 €	3,06 €	25
FI3\8X80	1/2"X3/8" MF CM 80	3,26 €	3,62 €	25
FI3\8X100	1/2"X3/8" MF CM 100	3,74 €	4,16 €	25

Flex inox 7 fili dadi e cartelle in ottone 1/2" M. prolungato F.



Codice	Riferimenti	Listino A	Listino B	Box
FI20P	1/2" MF CM 20	2,35 €	2,61 €	25
FI25P	1/2" MF CM 25	3,42 €	3,79 €	25
FI30P	1/2" MF CM 30	3,54 €	3,93 €	25
FI35P	1/2" MF CM 35	3,67 €	4,07 €	25
FI40P	1/2" MF CM 40	3,80 €	4,21 €	25
FI50P	1/2" MF CM 50	4,05 €	4,49 €	25
FI60P	1/2" MF CM 60	4,30 €	4,77 €	25
FI80P	1/2" MF CM 80	3,59 €	3,99 €	25
FI100P	1/2" MF CM 100	4,02 €	4,47 €	25

Flex inox 7 fili dadi e cartelle in ottone 1/2"X3/8" M. prolungato F.



Codice	Riferimenti	Listino A	Listino B	Box
FI3\8X20P	1/2"X3/8" MF CM 20	1,87 €	2,07 €	25
FI3\8X25P	1/2"X3/8" MF CM 25	3,29 €	3,65 €	25
FI3\8X30P	1/2"X3/8" MF CM 30	3,42 €	3,79 €	25
FI3\8X35P	1/2"X3/8" MF CM 35	3,54 €	3,93 €	25
FI3\8X40P	1/2"X3/8" MF CM 40	2,58 €	2,86 €	25
FI3\8X50P	1/2"X3/8" MF CM 50	3,92 €	4,35 €	25
FI3\8X60P	1/2"X3/8" MF CM 60	4,17 €	4,63 €	25
FI3\8X80P	1/2"X3/8" MF CM 80	3,68 €	4,09 €	25
FI3\8X100P	1/2"X3/8" MF CM 100	4,21 €	4,68 €	25



Flessibile in Acciaio Inox per alimentatore aria con dado lungo.
Flexible in Steel Inox per Feeder Air with long die

Codice	Riferimenti	Listino A	Listino B	Box
FABD700	1/4"X1/2" 70 cm	6,83 €	7,58 €	25
FADG1000	1/2"X3/4" 100 cm	15,94 €	17,69 €	25
FADG1500	1/2"X3/4" 150 cm	15,94 €	17,69 €	25

PRODOTTI
MADE IN ITALY



Flex inox gigante dadi e cartelle in ottone 1/2" MF



Codice	Riferimenti	Listino A	Listino B	Box
FI20GFF	1/2" MF CM 20	3,62 €	4,01 €	25
FI25GFF	1/2" MF CM 25	3,83 €	4,25 €	25
FI30GFF	1/2" MF CM 30	4,04 €	4,48 €	25
FI35GFF	1/2" MF CM 35	4,24 €	4,71 €	25
FI40GFF	1/2" MF CM 40	4,45 €	4,94 €	25
FI50GFF	1/2" MF CM 50	5,12 €	5,68 €	25

Flex inox gigante dadi e cartelle in ottone 1/2" MF



Codice	Riferimenti	Listino A	Listino B	Box
FI20G	1/2" MF CM 20	3,70 €	4,11 €	25
FI25G	1/2" MF CM 25	3,91 €	4,34 €	25
FI30G	1/2" MF CM 30	4,12 €	4,57 €	25
FI35G	1/2" MF CM 35	4,33 €	4,80 €	25
FI40G	1/2" MF CM 40	4,54 €	5,04 €	25
FI50G	1/2" MF CM 50	5,20 €	5,77 €	25
FI60G	1/2" MF CM 60	5,65 €	6,27 €	25
FI80G	1/2" MF CM 80	6,52 €	7,24 €	25
FI100G	1/2" MF CM 100	7,41 €	8,22 €	25

Flex inox gigante dadi e cartelle in ottone 1/2"X3/8" MF



Codice	Riferimenti	U.M.	Busta	Box	Listino
FI3\8X20G	1/2"X3/8" MF CM 20		3,70 €	4,11 €	25
FI3\8X25G	1/2"X3/8" MF CM 25		3,91 €	4,34 €	25
FI3\8X30G	1/2"X3/8" MF CM 30		4,12 €	4,57 €	25
FI3\8X35G	1/2"X3/8" MF CM 35		4,33 €	4,80 €	25
FI3\8X40G	1/2"X3/8" MF CM 40		4,54 €	5,04 €	25
FI3\8X50G	1/2"X3/8" MF CM 50		5,20 €	5,77 €	25
FI3\8X60G	1/2"X3/8" MF CM 60		5,65 €	6,27 €	25
FI3\8X80G	1/2"X3/8" MF CM 80		6,52 €	7,24 €	25
FI3\8X100G	1/2"X3/8" MF CM 100		7,41 €	8,22 €	25

Flex inox gigante dadi e cartelle in ottone 1/2"X3/8" M. prolungato F.



Codice	Riferimenti	Listino A	Listino B	Box
FI3\8X20GP	1/2"X3/8" MF CM 20	4,22 €	4,68 €	25
FI3\8X25GP	1/2"X3/8" MF CM 25	4,43 €	4,91 €	25
FI3\8X30GP	1/2"X3/8" MF CM 30	4,64 €	5,15 €	25
FI3\8X35GP	1/2"X3/8" MF CM 35	4,85 €	5,38 €	25
FI3\8X40GP	1/2"X3/8" MF CM 40	5,06 €	5,61 €	25
FI3\8X50GP	1/2"X3/8" MF CM 50	5,75 €	6,38 €	25
FI3\8X60GP	1/2"X3/8" MF CM 60	6,18 €	6,87 €	25
FI3\8X80GP	1/2"X3/8" MF CM 80	7,07 €	7,85 €	25
FI3\8X100GP	1/2"X3/8" MF CM 100	7,95 €	8,83 €	25

Acciaio Inox 9 fili con raccordi: Maschio / Femmina Sede Piana

Stainless steel braiding 9 wires

Fittings: Male x Female

Flex inox gigante dadi e cartelle in ottone 1/2" M. prolungato F.



Codice	Riferimenti	Listino A	Listino B	Box
FI20GP	1/2" MF CM 20	4,22 €	4,68 €	25
FI25GP	1/2" MF CM 25	4,43 €	4,91 €	25
FI30GP	1/2" MF CM 30	4,64 €	5,15 €	25
FI35GP	1/2" MF CM 35	4,85 €	5,38 €	25
FI40GP	1/2" MF CM 40	5,06 €	5,61 €	25
FI50GP	1/2" MF CM 50	5,75 €	6,38 €	25
FI60GP	1/2" MF CM 60	6,18 €	6,87 €	25
FI80GP	1/2" MF CM 80	7,07 €	7,85 €	25
FI100GP	1/2" MF CM 100	7,95 €	8,83 €	25

PRODOTTI MADE IN ITALY



Codice	Riferimenti	Listino A	Listino B	Box
FM8X30	1/2"MX8X30	1,92 €	2,13 €	25
FM8X35	1/2"MX8X35	2,02 €	2,25 €	25
FM8X40	1/2"MX8X40	2,13 €	2,36 €	25



Codice	Riferimenti	Listino A	Listino B	Box
FM8X30L	1/2"MX8X30	2,20 €	2,44 €	25
FM8X35L	1/2"MX8X35	2,30 €	2,56 €	25
FM8X40L	1/2"MX8X40	2,40 €	2,67 €	25



Codice	Riferimenti	Listino A	Listino B	Box
FM25	U. 1/2"F CM. 25	2,76 €	3,07 €	25
FM30	U. 1/2"F CM. 30	2,88 €	3,19 €	25
FM35	U. 1/2"F CM. 35	2,30 €	2,56 €	25
FM3/8X25	U. 3/8"F CM. 25	2,64 €	2,93 €	25
FM3/8X30	U. 3/8"F CM. 30	1,98 €	2,20 €	25
FM3/8X35	U. 3/8"F CM. 35	1,77 €	1,97 €	25

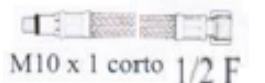

Codice	Riferimenti	Listino A	Listino B	Box
FM25L	U. 1/2"F CM. 25	2,33 €	2,58 €	25
FM30L	U. 1/2"F CM. 30	3,20 €	3,55 €	25
FM35L	U. 1/2"F CM. 35	3,05 €	3,39 €	25
FM3/8X25L	U. 3/8"F CM. 25	3,08 €	3,42 €	25
FM3/8X30L	U. 3/8"F CM. 30	3,20 €	3,55 €	25
FM3/8X35L	U. 3/8"F CM. 35	3,05 €	3,39 €	25



Codice	Riferimenti	Listino A	Listino B	Box
FM12X25	U. 1/2"F CM. 25	3,31 €	3,67 €	25
FM12X30	U. 1/2"F CM. 30	3,31 €	3,67 €	25
FM12X35	U. 1/2"F CM. 35	3,44 €	3,82 €	25
FM12X40	U. 1/2"F CM. 35	3,58 €	3,97 €	25
FM3/8X12X25	U. 3/8"F CM. 25	3,31 €	3,67 €	25
FM3/8X12X30	U. 3/8"F CM. 30	3,31 €	3,67 €	25
FM3/8X12X35	U. 3/8"F CM. 35	3,44 €	3,82 €	25
FM3/8X12X40	U. 3/8"F CM. 40	3,58 €	3,97 €	25

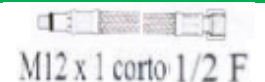

Codice	Riferimenti	Listino A	Listino B	Box
FMU10X25	M10x10 CM. 25	1,96 €	2,17 €	25
FMU10X30	M10x10 CM. 30	2,08 €	2,31 €	25
FMU10X35	M10x10 CM. 35	2,19 €	2,43 €	25
FMU10X40	M10x10 CM. 40	2,30 €	2,56 €	25
FMU10X50	M10x10 CM. 50	2,66 €	2,95 €	25



Codice	Riferimenti	Listino A	Listino B	Box
FI12FX10X25	1/2"FX10X25	3,54 €	3,93 €	25
FI12FX10X30	1/2"FX10X30	2,78 €	3,09 €	25
FI12FX10X35	1/2"FX10X35	2,91 €	3,23 €	25
FI12FX10X40	1/2"FX10X40	3,16 €	3,51 €	25
FI12FX10X50	1/2"FX10X50	4,38 €	4,86 €	25

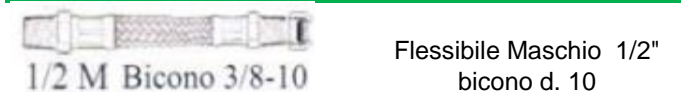

Codice	Riferimenti	Listino A	Listino B	Box
FI12X10X25	1/2"MX10X25	3,49 €	3,87 €	25
FI12X10X30	1/2"MX10X30	2,88 €	3,20 €	25
FI12X10X35	1/2"MX10X35	3,04 €	3,37 €	25
FI12X10X40	1/2"MX10X40	3,16 €	3,51 €	25
FI12X10X50	1/2"MX10X50	3,53 €	3,92 €	25



Codice	Riferimenti	Listino A	Listino B	Box
FI3/8FX10X25	3/8"FX10X25	3,54 €	3,93 €	25
FI3/8FX10X30	3/8"FX10X30	3,67 €	4,07 €	25
FI3/8FX10X35	3/8"FX10X35	3,79 €	4,21 €	25
FI3/8FX10X40	3/8"FX10X40	3,92 €	4,35 €	25
FI3/8FX10X50	3/8"FX10X50	4,38 €	4,86 €	25





Antivibrante MF

Codice	Riferimenti	Listino A	Listino B	Box
A1\2X20	1/2"X20 CM	2,17 €	2,41 €	25
A1\2X25	1/2"X25 CM	4,79 €	5,32 €	25
A1\2X30	1/2"X30 CM	5,08 €	5,64 €	25
A1\2X35	1/2"X35 CM	5,37 €	5,96 €	25
A1\2X40	1/2"X40 CM	5,69 €	6,31 €	25
A1\2X50	1/2"X50 CM	6,30 €	6,99 €	25
A1\2X60	1/2"X60 CM	6,63 €	7,36 €	25
A1\2X70	1/2"X70 CM	5,33 €	5,91 €	25
A1\2X80	1/2"X80 CM	5,10 €	5,66 €	25
A1\2X100	1/2"X100 CM	9,03 €	10,03 €	25

Antivibrante MF da 1"



Antivibrante MF

Codice	Riferimenti	Listino A	Listino B	Box
A3\4X20	3/4"X20 CM	5,16 €	5,73 €	25
A3\4X25	3/4"X25 CM	5,66 €	6,29 €	25
A3\4X30	3/4"X30 CM	7,62 €	8,46 €	25
A3\4X35	3/4"X35 CM	6,24 €	6,93 €	25
A3\4X40	3/4"X40 CM	8,57 €	9,52 €	25
A3\4X50	3/4"X50 CM	8,86 €	9,83 €	25
A3\4X60	3/4"X60 CM	9,61 €	10,67 €	25
A3\4X70	3/4"X70 CM	8,11 €	9,00 €	25
A3\4X80	3/4"X80 CM	10,42 €	11,57 €	25
A3\4X100	3/4"X100 CM	12,27 €	13,62 €	25

Antivibrante MF da 1 1/4"



Antivibrante MF

Codice	Riferimenti	Listino A	Listino B	Box
A1X20	1"X20 CM	8,24 €	9,15 €	25
A1X25	1"X25 CM	8,57 €	9,52 €	25
A1X30	1"X30 CM	11,38 €	12,63 €	25
A1X35	1"X35 CM	9,31 €	10,34 €	25
A1X40	1"X40 CM	11,62 €	12,90 €	25
A1X50	1"X50 CM	13,39 €	14,86 €	25
A1X60	1"X60 CM	13,81 €	15,33 €	25
A1X80	1"X80 CM	15,96 €	17,71 €	25
A1X100	1"X100 CM	19,87 €	22,06 €	25



Antivibrante MF

Codice	Riferimenti	Listino A	Listino B	Box
A11\4X20	1 1/4"X20 CM	15,96 €	17,71 €	25
A11\4X25	1 1/4"X25 CM	16,69 €	18,53 €	25
A11\4X30	1 1/4"X30 CM	18,42 €	20,45 €	25
A11\4X35	1 1/4"X35 CM	17,92 €	19,89 €	25
A11\4X40	1 1/4"X40 CM	21,46 €	23,82 €	25
A11\4X50	1 1/4"X50 CM	24,55 €	27,25 €	25
A11\4X60	1 1/4"X60 CM	26,33 €	29,23 €	25
A11\4X80	1 1/4"X80 CM	32,23 €	35,78 €	25
A11\4X100	1 1/4"X100 CM	38,09 €	42,28 €	25



Antivibrante MF

Codice	Riferimenti	Listino A	Listino B	Box
A11\2X20	1 1/2"X20 CM	20,71 €	22,99 €	25
A11\2X25	1 1/2"X25 CM	21,77 €	24,16 €	25
A11\2X30	1 1/2"X30 CM	27,76 €	30,81 €	25
A11\2X35	1 1/2"X35 CM	24,18 €	26,84 €	25
A11\2X40	1 1/2"X40 CM	31,77 €	35,27 €	25
A11\2X50	1 1/2"X50 CM	35,78 €	39,72 €	25
A11\2X60	1 1/2"X60 CM	39,75 €	44,12 €	25
A11\2X80	1 1/2"X80 CM	47,87 €	53,13 €	25
A11\2X100	1 1/2"X100 CM	55,70 €	61,83 €	25



Antivibrante MF

Codice	Riferimenti	Listino A	Listino B	Box
A2X20	2"X20 CM	36,43 €	40,44 €	25
A2X25	2"X25 CM	36,43 €	40,44 €	25
A2X30	2"X30 CM	44,27 €	49,14 €	25
A2X35	2"X35 CM	33,60 €	37,30 €	25
A2X40	2"X40 CM	49,34 €	54,77 €	25
A2X50	2"X50 CM	54,51 €	60,50 €	25
A2X60	2"X60 CM	59,72 €	66,28 €	25
A2X80	2"X80 CM	70,05 €	77,75 €	25
A2X100	2"X100 CM	79,91 €	88,70 €	25

Antivibrante Maschio Retto Femmina Curvo con girello



Antivibrante Maschio Retto Femmina Curvo con girello

Codice	Riferimenti	Listino A	Listino B	Box
AC1X40	1"X40 CM	18,04 €	20,02 €	25
AC1X50	1"X50 CM	23,36 €	25,93 €	25
AC1X60	1"X60 CM	19,58 €	21,74 €	25



Rosetta Larga Da 1/2" Cm. 7
Ottone Cromato RL1\2

Codice	Riferimenti	Listino A	Listino B	Off.	Box
RL1\2		0,50 €	0,55 €	1	12



Rosetta Inox Foro Esagonale
2906ID

Codice	Riferimenti	Listino A	Listino B	Off.	Box
2906ID		0,23 €	0,25 €	1	12



Rosone Acciaio Inox 1/2" 2900ID

Codice	Riferimenti	Listino A	Listino B	Off.	Box
2900ID		0,23 €	0,25 €	1	12



Rosetta Biella 1/2" Cromo
R1\200

Codice	Riferimenti	Listino A	Listino B	Off.	Box
R1\200		0,43 €	0,48 €	1	12



Curvetta 1/2"X10 Cromo Esag.
C1\2X10E

Codice	Riferimenti	Listino A	Listino B	Off.	Box
C1\2X10E	1	5,31 €	5,89 €	1	12
C1\2X10Ex20	x20	5,02 €	5,57 €	1	12
C1\2X10Ex50	x50	4,73 €	5,25 €	1	12
C1\2X10Ex100	x100	4,53 €	5,03 €	1	12



Rub. Filtro Snodo 1/2"X10
RF1\2X10

Codice	Riferimenti	Listino A	Listino B	Off.	Box
RF1\2X10	1	7,04 €	7,82 €	1	12
RF1\2X10x20	x20	6,66 €	7,39 €	1	12
RF1\2X10x50	x50	6,28 €	6,97 €	1	12
RF1\2X10x100	x100	6,02 €	6,68 €	1	12



Nipples Cromo F. 1/2"X10
NFC1\2X10

Codice	Riferimenti	Listino A	Listino B	Off.	Box
NFC1\2X10	10 x 1/2	1,64 €	1,83 €	1	12

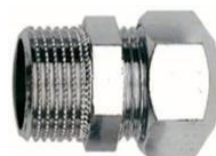

Niplo Cromo Mon. 1/2"X
3/8"X10 NMC1\2X10

Codice	Riferimenti	Listino A	Listino B	Off.	Box
NM3\8X10	10 x 3/8	1,83 €	2,03 €	1	12
NMC1\2X10	10 x 1/2	1,64 €	1,83 €	1	12



Nipples Esag. 1/2"X3/8"X10 C/Ro
NMCPD10

Codice	Riferimenti	Listino A	Listino B	Off.	Box
NMCPD10	1/2"X(3/8"X10)	2,35 €	2,61 €	1	12



Niples Ridotta Prolungata
Cromata 1/2"X3/8

Codice	Riferimenti	Listino A	Listino B	Off.	Box
N CPRDC	1/2"X3/8"	2,16 €	2,40 €	1	12
N CPRDD	1/2"X1/2"	2,01 €	2,23 €	1	12



Rame Cotto Cromato Da 10 Mm
RC10

Codice	Riferimenti	Listino A	Listino B	Off.	Box
RC10	Mt. 5	5,13 €	5,69 €	1	5



Rubinetto Filtro 1/2"X10 Vitone
RF1\2X10V

Codice	Riferimenti	Listino A	Listino B	Off.	Box
RF1\2X10V	1	6,37 €	7,07 €	1	12
RF1\2X10Vx20	x20	6,02 €	6,68 €	1	12
RF1\2X10Vx50	x50	5,68 €	6,30 €	1	12
RF1\2X10Vx100	x100	5,44 €	6,04 €	1	12

?

LA SCELTA FACILE

Guarnizioni Esente aminato - gomma - morsetti



Sigillanti & Teflon per Acqua - Gas

Pasta Verde - Canapa e derivati per l'idraulica



Estensibili & tubi collegamento per scarichi

Accessori - Tubi carico & scarico lavatrice





Guarnizione Esente Mm.2
1/4" 2100ESE0B

Codice	Riferimenti	Listino A	Listino B	Off.	Box
2100ESE0B	1/4"	0,020 €	0,022 €	1	100
2100ESE0C	3/8"	0,016 €	0,018 €	1	100
2100ESE0D	1/2"	0,024 €	0,026 €	1	100
2100ESE0G	3/4"	0,024 €	0,027 €	1	100
2100ESE0H	1"	0,032 €	0,036 €	1	100
2100ESEHB	1"1/4	0,056 €	0,062 €	1	100
2100ESEHD	1"1/2	0,066 €	0,073 €	1	100
2100ESEOL	2"	0,383 €	0,425 €	1	100
2100ESELD	2"1/2	0,128 €	0,143 €	1	100



Guarnizione per Radiatori 1
Mm. 1" Preo Pz. 1
1094RAE10H

Codice	Riferimenti	Listino A	Listino B	Off.	Box
1094RAE10H	1"	0,065 €	0,073 €	1	100
1094RAE1HB	1"1/4	0,055 €	0,061 €	1	100



Guarnizione Gpl Cuoio
17X10X2 5020CUOIO

Codice	Riferimenti	Listino A	Listino B	Off.	Box
5020CUOIO	17X10X2	0,034 €	0,038 €	1	100
5020NBR	1/2 17X10,5	0,104 €	0,115 €	1	100



Guarn. Stamp. X Rubi.
D.3/8X4 GRS3/8

Codice	Riferimenti	Listino A	Listino B	Off.	Box
GRS3/8	3/8"	0,082 €	0,091 €	1	100
GRS1/2	1/2"	0,091 €	0,101 €	1	100
GRS3/4	3/4"	0,120 €	0,133 €	1	100
GRS1	1"	Arrivo	Arrivo	1	100



Bordo leggero in gomma NR
bianca

Codice	Riferimenti	Listino A	Listino B	Off.	Pz
GSP1/2	D. 1/2"	0,243 €	0,270 €	1	50
GSP3/4	D. 3/4"	0,347 €	0,385 €	1	50
GSP1	D. 1"	0,309 €	0,343 €	1	50
GSP11/4	D. 11/4"	0,401 €	0,445 €	1	50
GSP11/2	D. 11/2"	0,340 €	0,378 €	1	50



Guarnizione Epdm Per Tubo
Flessibile Filett H 3/8 GGT0C

Codice	Riferimenti	Listino A	Listino B	Off.	Box
GGT0C	3/8"	0,046 €	0,051 €	1	100
GGT0D	1/2"	0,055 €	0,061 €	1	100
GGT0G	3/4"	0,074 €	0,082 €	1	100
GGT0H	1"	0,111 €	0,123 €	1	100
GGTHB	1"1/4	0,203 €	0,225 €	1	100
GGTHD	1"1/2	0,230 €	0,256 €	1	100
GGTOL	2"	0,295 €	0,327 €	1	100



Guarnizione per Radiatore 2
Mm. 1" 1094RAE20H

Codice	Riferimenti	Listino A	Listino B	Off.	Box
1094RAE20H	1"	0,050 €	0,056 €	1	100
1094RAE2HB	1"1/4	0,064 €	0,071 €	1	100



Guarnizione In Alluminio
D.1/2" 5029GUARD

Codice	Riferimenti	Listino A	Listino B	Off.	Box
5029GUARD	1/2"	0,263 €	0,292 €	1	100
5029GUARG	3/4"	0,286 €	0,317 €	1	100



Guarnizione Per Rubinetto
3/8 In Gomma Nr Nera 70 Sh
A 6 Atm GRF3/8

Codice	Riferimenti	Listino A	Listino B	Off.	Box
GRF3/8	3/8"	0,064 €	0,071 €	1	100
GRF1/2	1/2"	0,064 €	0,071 €	1	100
GRF3/4	3/4"	0,120 €	0,133 €	1	100
GRF1	1"	Arrivo	Arrivo	1	100



Guarnizione conica in gomma
NR bianca

Codice	Riferimenti	Listino A	Listino B	Off.	Pz
GCP1/2	D. 1/2"	0,160 €	0,178 €	1	50
GCP3/4	D. 3/4"	0,276 €	0,306 €	1	50
GCP1	D. 1"	0,357 €	0,396 €	1	50
GCP11/4	D. 11/4"	0,455 €	0,505 €	1	50
GCP11/2	D. 11/2"	0,366 €	0,406 €	1	50



Benda Vinilica Bianca H.10 25M



Guarnizione Per Canotta
Nera Conida D. 26 Pz. 1 GC26

Codice	Riferimenti	Listino A	Listino B	Off.	Pz
RBVB	Bianco	4,13 €	4,59 €	1	10
RBVGC	Grigio Chiaro	4,38 €	4,87 €	1	10
RBVBLU	Blu	4,38 €	4,87 €	1	10
RBVR	Rosso	4,38 €	4,87 €	1	10

Codice	Riferimenti	Listino A	Listino B	Off.	Box
GC26	24/26	11,386 €	12,638 €	1,000 €	100,000 €
GC30	30	0,077 €	0,085 €	1,000 €	100,000 €
GC32	32	0,084 €	0,093 €	1,000 €	100,000 €
GC40	40	0,153 €	0,170 €	1,000 €	100,000 €
GC50	50	0,207 €	0,230 €	1,000 €	100,000 €



Rot.Nastro X
Filet.12X12X0,075 Zz
RTPTFE01



Strip sezione piatta grigis 10x3
(su 6 file in bobine da mt. 25 =
150 mt totale) prezzo al mt. Cod.
0051005

Codice	Riferimenti	Listino A	Listino B	Off.	Box
RTPTFE01	12x10x0,076	0,23 €	0,25 €	1	100

Codice	Riferimenti	Listino A	Listino B	Off.	Box
0051005	Grigio	0,61 €	0,67 €	1	100



Rotolo Nastro X Gas
12X12X0,10Zz RTGAS01



Strisce 8 X 15 X 490 Mm X 4
Sigillante Per Lavelli Zx
ELA0450

Codice	Riferimenti	Listino A	Listino B	Off.	Box
RTGAS01	12x12x0,10	0,30 €	0,34 €	1	100

Codice	Riferimenti	Listino A	Listino B	Off.	Box
ELA0450	4 strisce	4,95 €	5,50 €	1	100



Rotolo Nastro X Gas
19X15X0,20 Zx RTGAS02



Canapa Pettinata Prezzo A
Matassina Piccola Ogni 16
Matassine Corrispondono 1
Kg. CPM

Codice	Riferimenti	Listino A	Listino B	Off.	Box
RTGAS02	19x15x0,20	1,20 €	1,33 €	1	100

Codice	Riferimenti	Listino A	Listino B	Off.	Box
CPM		1,58 €	1,75 €	1	100



Rotolo Loctite Mt.150 Rot.
L55



Pasta Siliconica X Filetti PVS

Codice	Riferimenti	Listino A	Listino B	Off.	Box
L55		19,17 €	21,28 €	1	12

Codice	Riferimenti	Listino A	Listino B	Off.	Box
PVS		6,89 €	7,65 €	1	100



Stucco Sanitari Gr. 850
13010001



Pasta Verde Giun. Fil.
Sicurverde 460 Gr PV

Codice	Riferimenti	Listino A	Listino B	Off.	Box
13010001	850 gr.	6,12 €	6,80 €	1	12

Codice	Riferimenti	Listino A	Listino B	Off.	Box
PV		3,05 €	3,38 €	1	100



Tappo Provaimpi. Rosso Da
1/2" TPIRD

Codice	Riferimenti	Listino A	Listino B	Off.	Box
TPIRD	rosso	0,253 €	0,281 €	1	50
TPIBD	blue	0,253 €	0,281 €	1	50



Scatola 419 Pz Assortiti Zx
GUKIT01

Codice	Riferimenti	Listino A	Listino B	Off.	Box
GUKIT01		17,534 €	19,463 €	1	50

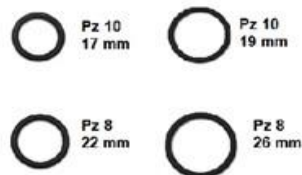

Set Oring 36 Pz
pz. 10 d. 17
pz. 10 d. 19
pz. 8 d. 25
pz. 8 d. 26 602508

Codice	Riferimenti	Listino A	Listino B	Off.	Box
602508		1,896 €	2,104 €	1	50



Morsetto Interno D. 32x
25/26 MI32X25/26

Codice	Riferimenti	Listino A	Listino B	Off.	Box
MI32X25/26		0,328 €	0,364 €	1	50



Morsetto In Gomma interno
D. 40X26/32 MI40X26/32

Codice	Riferimenti	Listino A	Listino B	Off.	Box
MI40X26/32		0,326 €	0,362 €	1	50



Mors.Gomma Sotto Vaso
50X26/32 MI50X26/32

Codice	Riferimenti	Listino A	Listino B	Off.	Box
MI50X26/32		0,337 €	0,374 €	1	50



Verga In Lega Stagno 33% Kg.
1 STST33

Codice	Riferimenti	Listino A	Listino B	Off.	Box
STST33		7,920 €	8,791 €	1	50



Stearina In Pani Kg. 1 STCS01

Codice	Riferimenti	Listino A	Listino B	Off.	Box
STCS01		4,482 €	4,975 €	1	50



Filtro Retinato X Lav D. 1/2"
1313RETD

Codice	Riferimenti	Listino A	Listino B	Off.	Box
1313RETD	1/2"	0,200 €	0,222 €	1	50
1313RETG	3/4"	0,219 €	0,243 €	1	50



Morsetto In Gomma M.
32X25/26 ME32X25/26

Codice	Riferimenti	Listino A	Listino B	Off.	Box
ME32X25/26		0,322 €	0,358 €	1	50
ME40X25/26		0,645 €	0,716 €	1	50



Mors. Gomma Sotto Vaso
46X40 MI46X40

Codice	Riferimenti	Listino A	Listino B	Off.	Box
MI46X40		0,179 €	0,199 €	1	50



Mors. Gomma Sotto Vaso
110/120 Zz MSWC110/120

Codice	Riferimenti	Listino A	Listino B	Off.	Box
MSWC110/120		1,771 €	1,966 €	1	50



Mors.X Scarico Condens.
M.34X14 MSC34X14

Codice	Riferimenti	Listino A	Listino B	Off.	Box
MSC34X14		0,842 €	0,935 €	1	50



Morsetto Gomma B. Wc
50X30Zz MWC50X30

Codice	Riferimenti	Listino A	Listino B	Off.	Box
MWC50X30		0,291 €	0,323 €	1	50



Mors. Maggiorato X Wc M.
55X30 MWC55X30

Codice	Riferimenti	Listino A	Listino B	Off.	Box
MWC55X30		0,574 €	0,637 €	1	50



Morsetto Gomma lianca per
Wc D. 60X30 MWC60X30

Codice	Riferimenti	Listino A	Listino B	Off.	Box
MWC60X30		0,450 €	0,500 €	1	50



Mini Sfera Senza Nottolino
Tipo Nuovo Cass. Catis
GMSSN34

Codice	Riferimenti	Listino A	Listino B	Off.	Box
GMSSN34	34	0,949 €	1,053 €	1	50



Mors. In Gomma X Vaso
60X40/44 MWC60X40/44

Codice	Riferimenti	Listino A	Listino B	Off.	Box
MWC60X40/44		0,501 €	0,556 €	1	50



Mors.Gomma B. X Sifoni
M.76X50 MWC76X50

Codice	Riferimenti	Listino A	Listino B	Off.	Box
MWC76X50	76x50	2,067 €	2,294 €	1	50
MWC70X50	70x50	2,068 €	2,295 €	1	50



Mors.Gomma B. X Sifoni
M.76X30 MWC76X30

Codice	Riferimenti	Listino A	Listino B	Off.	Box
MWC76X30	76x30	1,493 €	1,657 €	1	50
MWC76X40	76x40	1,444 €	1,444 €	1	50



Minisfera In Gomma Nr Per
Batteria Catis GMSCN34

Codice	Riferimenti	Listino A	Listino B	Off.	Box
GMSCN34	34	0,692 €	0,768 €	1	50



Sfera Con Nottolino 69,5H
Mm53 GSCBSM5

Codice	Riferimenti	Listino A	Listino B	Off.	Box
GSCBSM5	D. 69,5 H mm 53	2,034 €	2,258 €	1	50



Manicotto Gomma Nero
Antical. 32/32 MGNR2626

Codice	Riferimenti	Listino A	Listino B	Off.	Box
MGNR2626	26-26	1,192 €	1,323 €	1	50
MGNR3226	32-26	1,061 €	1,178 €	1	50
MGNR3232	32-32	1,017 €	1,129 €	1	50
MGNR4026	40-26	1,318 €	1,463 €	1	50
MGNR4032	40-32	1,017 €	1,129 €	1	50
MGNR4040	40-40	1,017 €	1,129 €	1	50



Guar. Cilindrica Gomma Nr
19,7 GCGNR19,7

Codice	Riferimenti	Listino A	Listino B	Off.	Box
GCGNR19,7	19,7 H 11	0,110 €	0,123 €	1	50



Prolunga Eccentrica Wc Cm. 4
PEWC

Codice	Riferimenti	Listino A	Listino B	Off.	Box
PEWC	Eccentrica	4,17 €	4,63 €	1	50



Morsetto Retto Wc Da 110Zz
MRWC

Codice	Riferimenti	Listino A	Listino B	Off.	Box
MRWC	1	1,75 €	1,94 €	1	50
MRWCx5	5	1,60 €	1,78 €	1	50



bo Wc Bianco Con Rosone
TWC100X255

Codice	Riferimenti	Listino A	Listino B	Off.	Box
TWC100X255		6,45 €	7,16 €	1	50



Tubo Este.X Wc 200-540
Ter.Ppl EWCNFNTTO

Codice	Riferimenti	Listino A	Listino B	Off.	Box
EWCNFNTTO	Ter. PPL	10,99 €	12,20 €	1	50



Rosone X Tubo Rigido Dir. Per
Wc D. 110 3134ROSONE

Codice	Riferimenti	Listino A	Listino B	Off.	Box
3134ROSONE	D. 110	1,32 €	1,46 €	1	50
3134ROS100	D. 100	1,32 €	1,46 €	1	50
	D. 90	Arrivo	Arrivo	1	50



valvola di protezione per ratti
DN 90-100/110 mm, adattatore,
valvola per ratti, valvola di
ritegno, non ritorno VPAWC

Codice	Riferimenti	Listino A	Listino B	Off.	Box
VPAWC	1	8,86 €	9,83 €	1	50



Curva Wc Orientabile Scarico
Incollaggio Pvc 100 Nicoll
S1PWOR

Codice	Riferimenti	Listino A	Listino B	Off.	Box
S1PWOR		28,84 €	32,01 €	1	50



Morsetto Eccentrico Wc
MEWC

Codice	Riferimenti	Listino A	Listino B	Off.	Box
MEWC	1	1,75 €	1,94 €	1	50
MEWCx5	5	1,60 €	1,78 €	1	50



Connessione Estensibile Per
Wc Go-Magic-Lux 290/590
Mm C/Curva 1024ELBOW1

Codice	Riferimenti	Listino A	Listino B	Off.	Box
1024ELBOW1	350/620 mm	11,13 €	12,36 €	1	50



Tubo Este.X Wc 200-540
Ter.Abs EWCNFNABS

Codice	Riferimenti	Listino A	Listino B	Off.	Box
EWCNFNABS	Ter. ABS	7,08 €	7,86 €	1	50



Curva Sottovaso In Plas.
D.110 CWC110

Codice	Riferimenti	Listino A	Listino B	Off.	Box
CWC110	D. 110	7,11 €	7,89 €	1	50
CWC100	D. 100	4,61 €	5,11 €	1	50
CWC90	D. 90	4,74 €	5,27 €	1	50



Eccentrico Wc 100

Codice	Riferimenti	Listino A	Listino B	Off.	Box
EWC100X2	CM. 2	4,23 €	4,70 €	1	5
EWC100X4	CM. 4	4,23 €	4,70 €	1	5
EWC100X6	CM. 6	4,80 €	5,33 €	1	5



Estensibile 1"X32 Bonomini
E1X32B



Codice	Riferimenti	Listino A	Listino B	Off.	Box
E1X26B	1"x26	1,35 €	1,50 €	1	50
E1X32B	1"x32	1,61 €	1,78 €	1	50
E11/4X32B	11/4x32	1,53 €	1,70 €	1	50
E11/2X40B	11/2x40	1,51 €	1,67 €	1	50



Estensibile Ghiera Metallo

Codice	Riferimenti	Listino A	Listino B	Off.	Box
SFLEXH26	1"x26	1,67 €	1,85 €	1	50
SFLEXH32	1"x32	1,51 €	1,67 €	1	50
SFLEXHB32	11/4x32	1,58 €	1,75 €	1	50
SFLEXHB3240	11/4x32/40	0,94 €	1,05 €	1	50
SFLEXHD40	11/2x40	1,58 €	1,75 €	1	50
SFLEXHD4050	11/2x40/50	0,96 €	1,07 €	1	50



Estensibile Spiralo Anima In
Acciaio

Codice	Riferimenti	Listino A	Listino B	Off.	Box
SFLEXCH26	1"x26	5,91 €	6,56 €	1	50
SFLEXCH32	1"x32	5,91 €	6,56 €	1	50
SFLEXCHB32	11/4x32	5,93 €	6,58 €	1	50
SFLEXCHD32	11/4x40	5,91 €	6,56 €	1	50
SFLEXCHB40	11/2x40	5,93 €	6,58 €	1	50
SFLEXCHD40	11/2x50	5,91 €	6,56 €	1	50



Raccor. Rapido Cromato

Codice	Riferimenti	Listino A	Listino B	Off.	Box
SFLEXDH32	1"x32	4,35 €	4,83 €	1	50
SFLEXDHB32	11/4x32	4,35 €	4,83 €	1	50
SFLEXDHB3240	11/4x32/40	4,35 €	4,83 €	1	50
SFLEXDHD40	11/2x40	4,35 €	4,83 €	1	50
SFLEXDHD4050	11/2x40/50	4,35 €	4,83 €	1	50



Curva sc.estensibile cassetta
incasso attacco con
guarnizione da 110 attacco d.
100

Codice	Riferimenti	Listino A	Listino B	Off.	Box
CWC720		15,59 €	17,31 €	1	5

Estensibile Con Ghiera Plastica universale d, 1" - 11/4"
11/2"x32/40 + 3 guarnizioni SFLEXPUN

Tubo estensibile / comprimibile UNIVERSALE
con ghiera plastica e riduzione in PP



Codice	Riferimenti	Listino A	Listino B	Off.	Box
SFLEXPUN	1	2,22 €	2,46 €	1	50



Set allacciamento wc sospeso

Codice	Riferimenti	Listino A	Listino B	Off.	Box
718GTS		11,33 €	12,58 €	1	5



Raccordo wc Complex 25/60 d
100/110

Codice	Riferimenti	Listino A	Listino B	Off.	Box
EWC2560		5,08 €	5,63 €	1	5

Kit Scarico a L per lavello doppio 1"1/2 con goflex top quality
+ rosetta 1006SKIT04



Curve wc Complex 28-52

Codice	Riferimenti	Listino A	Listino B	Off.	Box
CWC2852		5,88 €	6,53 €	1	5

Codice	Riferimenti	Listino A	Listino B	Off.	Box
1006SKIT04	1	4,30 €	4,77 €	1	50



Tubo Carico Lavatrice Ff
Senza Curva

Codice	Riferimenti	Listino A	Listino B	Off.	Box
TPCL100	100 cm	2,23 €	2,47 €	1	50
TPCL150	150 cm	3,60 €	4,00 €	1	50
TPCL200	200 cm	4,11 €	4,56 €	1	50
TPCL250	250 cm	3,16 €	3,51 €	1	50
TPCL300	300 cm	3,49 €	3,88 €	1	50



Tubo Sca. Wash Fless Lav
60A200 Tsl200E TESLL200

Codice	Riferimenti	Listino A	Listino B	Off.	Box
TESLL200	60 a 200	2,37 €	2,63 €	1	50
TESLL300	90 a 300	2,82 €	3,13 €	1	50



Tubo Sca. Wash Fless Lav
60A200 TECSLL200

Codice	Riferimenti	Listino A	Listino B	Off.	Box
TECSLL200		1,94 €	2,15 €	1	50



Racc. Curvo Nylon X Lav
3/4X3/4 RCLNMF

Codice	Riferimenti	Listino A	Listino B	Off.	Box
RCLNMF	3/4X3/4	1,06 €	1,18 €	1	50



Nipples Doppio Mm 3/4 Pvc
NCLPVC

Codice	Riferimenti	Listino A	Listino B	Off.	Box
NCLPVC	3/4"	0,25 €	0,28 €	1	50



Racc. Diritto Tubo Sc. Lav
19X19 RDTSL1919

Codice	Riferimenti	Listino A	Listino B	Off.	Box
RDTSL1919	19x19	0,26 €	0,28 €	1	50
RDTSL1922	19x22	0,14 €	0,15 €	1	50
RDTSL2222	22x22	0,25 €	0,28 €	1	50



Tubo Car. Lav. Con Curva
Cm.100 Ex Tc100C TPCLC100

Codice	Riferimenti	Listino A	Listino B	Off.	Box
TPCLC100	100 cm	2,23 €	2,47 €	1	50
TPCLC150	150 cm	3,60 €	4,00 €	1	50
TPCLC200	200 cm	3,02 €	3,36 €	1	50
TPCLC250	250 cm	4,43 €	4,91 €	1	50
TPCLC300	300 cm	3,49 €	3,88 €	1	50



Tubo Scarico Lavatrice

Codice	Riferimenti	Listino A	Listino B	Off.	Box
TPSL100	100 cm	1,74 €	1,93 €	1	50
TPSL150	150 cm	1,79 €	1,99 €	1	50
TPSL200	200 cm	2,17 €	2,41 €	1	50
TPSL250	250 cm	1,05 €	1,17 €	1	50
TPSL300	300 cm	1,26 €	1,40 €	1	50



Supp. Curvo Plastic. A 180° X
Lav SCSL180

Codice	Riferimenti	Listino A	Listino B	Off.	Box
SCSL180	curva	0,23 €	0,25 €	1	50



Racc. Dop. Nylon Lav
3/4X3/4X3/4 RCLDNFMM

Codice	Riferimenti	Listino A	Listino B	Off.	Box
RCLDNFMM	3/4X3/4X3/4	1,47 €	1,63 €	1	50



Riduzione Bianca F/M
11/4X11/2" ARMHBHD

Codice	Riferimenti	Listino A	Listino B	Off.	Box
ARMHBHD	1"1/4x1"1/2	0,19 €	0,21 €	1	50



PRMHBH Riduzione Bianca F/M
11/4X1" PRMHBH

PRMHDHB Riduzione Bianca F/M
11/2"X11/4 Zz
PRMHDHB

Codice	Riferimenti	Listino A	Listino B	Off.	Box
PRMHBH	11/4"x1"	0,27 €	0,30 €	1	50
PRMHDHB	11/2"x11/4"	0,27 €	0,30 €	1	50



Raccordo "Y" Sc. Lavatrice
Pvc RYSL

Codice	Riferimenti	Listino A	Listino B	Off.	Box
RYSL	19-22	0,47 €	0,52 €	1	50



Sif.Inc.Lav B. Uscita 11/2"X40
SILPEHHD40

Codice	Riferimenti	Listino A	Listino B	Off.	Box
SILPEHHD40	Bianco	2,54 €	2,82 €	1	50



Sif.Inc.Lav Phed
Bianco+Uscita 40 Liscia
SILPEHB40

Codice	Riferimenti	Listino A	Listino B	Off.	Box
SILPEHB40	Bianco	2,67 €	2,97 €	1	50



Sifone Esterno X Lav Bianco
SELB

Codice	Riferimenti	Listino A	Listino B	Off.	Box
SELB	bianca	2,02 €	2,24 €	1	50



Raccordo Lavatrice Bianco 1"
RPLBH

Codice	Riferimenti	Listino A	Listino B	Off.	Box
RPLBH	bianca	0,61 €	0,67 €	1	50



Raccordo Doppio Per Due
Lavatrici O
Lavatrice/Asciugatrice
Attacco 1" 1268POLL00

Codice	Riferimenti	Listino A	Listino B	Off.	Box
1268POLL00		9,32 €	10,35 €	1	50



Attacco Lavatrice 11/4" X32
B. AL11\4

Codice	Riferimenti	Listino A	Listino B	Off.	Box
AL11\4	11/4"	1,83 €	2,03 €	1	50
AL11\2	11/2"	2,31 €	2,56 €	1	50

Codice	Riferimenti	Listino A	Listino B	Off.	Box
	Arrivo		Arrivo	1	50



Sif.Inc.Lav.Inox Usci.11/2"X40
SILPEHIHD40

Codice	Riferimenti	Listino A	Listino B	Off.	Box
SILPEHIHD40	Inox	2,42 €	2,68 €	1	50



Sif.Inc.Lav Phed Inox + Uscita
40 SILPEHI40

Codice	Riferimenti	Listino A	Listino B	Off.	Box
SILPEHI40	Inox	2,69 €	2,98 €	1	50



Racc. Port. Lav Cromo 1"
RPLCH

Codice	Riferimenti	Listino A	Listino B	Off.	Box
RPLCH	Cromo	0,61 €	0,68 €	1	50



Sifone Esterno Lav. Pvc
Cromo SELC

Codice	Riferimenti	Listino A	Listino B	Off.	Box
SELC	Cromo	3,19 €	3,54 €	1	50



Raccordo Doppio Per Due
Lavatrici O
Lavatrice/Asciugatrice
Attacco Liscio Ø32
1268USCI32

Codice	Riferimenti	Listino A	Listino B	Off.	Box
1268USCI32		8,82 €	9,79 €	1	50

Prolunga Moplen Pm11/4"X32X165 P11\4X230



Codice	Riferimenti	Listino A	Listino B	Off.	Box
P11\4X230	11/4"	1,55 €	1,72 €	1	50
P11\2X230	11/2"	2,31 €	2,56 €	1	50



Cannotto Con Attacco Lavatrice S75

Codice	Riferimenti	Listino A	Listino B	Off.	Box
S75	11/2"	0,82 €	0,91 €	1	50



Canotto Con Cartella 1 1/2 X 40 Con Due Attacchi Lavatrice 1006AT2LAV

Codice	Riferimenti	Listino A	Listino B	Off.	Box
1006AT2LAV	11/2"	1,67 €	1,85 €	1	50



Curvetta Scarico Lavatrice In Ottone Con Attacco Asciugatrice E Tappo Supplementare DCLCATA

Codice	Riferimenti	Listino A	Listino B	Off.	Box
	Arrivo	Arrivo		1	50



Sifone Moplen 2 V. 11/2" Magnum Tutto 11/2"

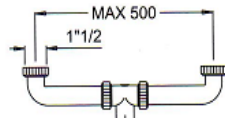

Codice	Riferimenti	Listino A	Listino B	Off.	Box
S2V11\2M	11/2"X40	4,89 €	5,43 €	1	50



Canotto Scarico 2 Vie 11/2" C2S11\2

Codice	Riferimenti	Listino A	Listino B	Off.	Box
C2S11\2	11/2"	2,10 €	2,33 €	1	50



Attacco Lavatrice 11/2" Filettato Mf AL11\2F

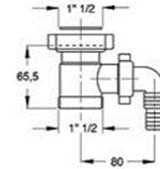

Codice	Riferimenti	Listino A	Listino B	Off.	Box
AL11\2F		2,23 €	2,48 €	1	50



Codice	Riferimenti	Listino A	Listino B	Off.	Box
DCLCATA		13,11 €	14,56 €	1	50



Sifone Moplen 2 Vie 11/2"X32 S2V11\2

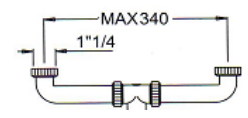

Codice	Riferimenti	Listino A	Listino B	Off.	Box
S2V11\2	11/2"X32	4,66 €	5,17 €	1	50



Sifone 2 Vie 11/4" Con Pilette S2V11\4C

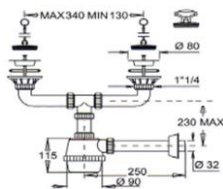

Codice	Riferimenti	Listino A	Listino B	Off.	Box
S2V11\4C	11/4"X32	9,22 €	10,24 €	1	50



Sifone 1 Via Moplen Da 11/4" Con Piletta S1V11\4C

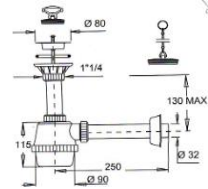

Codice	Riferimenti	Listino A	Listino B	Off.	Box
S1V11\4C	11/4"X32	4,71 €	5,23 €	1	50



Sifone Moplen 1 V. 11/2" Magnum Tutto 11/2" S1V11\2M

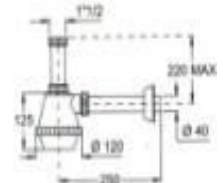

Codice	Riferimenti	Listino A	Listino B	Off.	Box
S1V11\2M	11/2"X40	3,51 €	3,90 €	1	50



Sifone 1 Via 11/4" S /Piletta S1V11\4

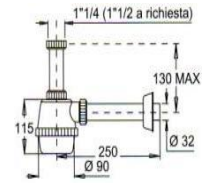

Codice	Riferimenti	Listino A	Listino B	Off.	Box
S1V11\4	11/4"X32	2,00 €	2,22 €	1	50



Sifone Lavello Autopulente A 1 Via 11/2" S/Piletta S1V11\2

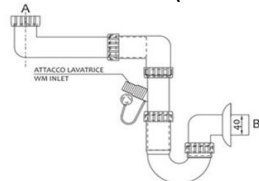

Codice	Riferimenti	Listino A	Listino B	Off.	Box
S1V11\2	11/2"X40	8,68 €	9,63 €	1	50



Sifone Industriale 2 Vie 11/2" S12V11\2

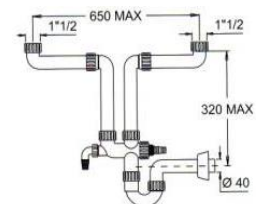

Codice	Riferimenti	Listino A	Listino B	Off.	Box
S12V11\2	11/2"X40	12,50 €	13,87 €	1	50



Coudix Manicotto
Flessibile D. 32
COU3252

Codice	Riferimenti	Listino A	Listino B	Off.	Box
COU3252	D.32 184-257	12,80 €	14,21 €	1	50
COU4052	D.40 212-294	21,61 €	23,98 €	1	50



Manicotto Flessibile 32
Mf FLEXANI

Codice	Riferimenti	Listino A	Listino B	Off.	Box
FLEXANI	D.32 MF	7,77 €	8,63 €	1	50
FLEXBNI	D.40 MF	9,11 €	10,11 €	1	50



Cestello Inox X Level.Pil
Baskzz CLBI

Codice	Riferimenti	Listino A	Listino B	Off.	Box
CLBI		5,31 €	5,90 €	1	50



Filtro per Lavello D.
11,3 79537

Import Export

Codice	Riferimenti	Listino A	Listino B	Off.	Box
79537		2,02 €	2,24 €	1	50



Filtro per Lavello D.
11,3 79537

Import Export

Codice	Riferimenti	Listino A	Listino B	Off.	Box
79537		2,02 €	2,24 €	1	50



feltro Isavello 7,5 cm.
pz. 2 10398

Import Export

Codice	Riferimenti	Listino A	Listino B	Off.	Box
10398		1,39 €	1,54 €	1	50



EF165C EASY-FLEX raccordo
flessibile uscita D. 50
attacco 50 oppure 40 ad
innesto

Codice	Riferimenti	Listino A	Listino B	Off.	Box
EF165C		5,34 €	5,93 €	1	50
EF165D		4,27 €	4,74 €	1	50

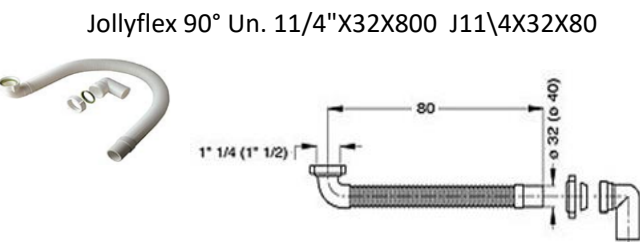

Jollyflex 90° Un. 11/4"X32X800 J11\4X32X80

Codice	Riferimenti	Listino A	Listino B	Off.	Box
J11\4X32X80		6,92 €	7,68 €	1	50
J11\2X40X80		8,29 €	9,20 €	1	50



Griglietta Per Lavelli
Inox GLI

Codice	Riferimenti	Listino A	Listino B	Off.	Box
GLI		0,55 €	0,61 €	1	50



Cestello Scattino D.80
Inox SCATTINO

Codice	Riferimenti	Listino A	Listino B	Off.	Box
SCATTINO		3,72 €	4,13 €	1	18



Tap Grill Il Nuovo
Tappo A Griglia
Raccogli Rifiuti
TAPGRILL

Codice	Riferimenti	Listino A	Listino B	Off.	Box
TAPGRILL		3,35 €	3,72 €	1	50



Tappo Lavandino
Universale Pop Pap
87250

Codice	Riferimenti	Listino A	Listino B	Off.	Box
87250		6,07 €	6,74 €	1	50



Sifone A Bottiglia 1"
SB1

Codice	Riferimenti	Listino A	Listino B	Off.	Box
SB1	1" Cromo	14,95 €	16,59 €	1	50
SB11/4	1 1/4" Cromo	17,20 €	19,09 €	1	50



Sifone A Bottiglia 1"
SB1

Codice	Riferimenti	Listino A	Listino B	Off.	Box
SB1	1" Cromo	14,95 €	16,59 €	1	50
SB11/4	1 1/4" Cromo	17,20 €	19,09 €	1	50



Sifone Arredo Tondo
Da 1"1/4 SIFT

Codice	Riferimenti	Listino A	Listino B	Off.	Box
SIFT		28,91 €	32,09 €	1	50



Sifone Arredo Quadro
Da 1"1/4 SIFQZ

Codice	Riferimenti	Listino A	Listino B	Off.	Box
SIFQZ		39,56 €	43,92 €	1	50



Piletta Click Clack
Universale D. 1"1/4
PCU

Codice	Riferimenti	Listino A	Listino B	Off.	Box
PCU	1 1/4" Cromo	18,52 €	20,56 €	1	50



Piletta Click Clack
Universale Quadrata Zz
PCUQ

Codice	Riferimenti	Listino A	Listino B	Off.	Box
PCUQ	1 1/4" Cromo	23,81 €	26,43 €	1	50



Piletta Norton Tappo
Leggero Da 1" PNEH

Codice	Riferimenti	Listino A	Listino B	Off.	Box
PNEH	1" cromo	6,30 €	6,99 €	1	50
PNEHB	1 1/4" cromo	7,01 €	7,78 €	1	50



Piletta Da 1" Pesante
PNLH

Codice	Riferimenti	Listino A	Listino B	Off.	Box
PNLH	1" cromo	12,45 €	13,82 €	1	50
PNLHB	1 1/4" cromo	12,45 €	13,82 €	1	50



Tappo Piletta Norton
1" Pvc TPN1

Codice	Riferimenti	Listino A	Listino B	Off.	Box
TPN1	1"	1,89 €	2,10 €	1	50
TPN11/4	1 1/4"	1,89 €	2,10 €	1	50



Tappo Piletta 1"
Pesanti TPNOCH

Codice	Riferimenti	Listino A	Listino B	Off.	Box
TPNOCH	1"	3,78 €	4,20 €	1	50
TPNOCHB	1 1/4"	4,06 €	4,51 €	1	50



Tappo Saltarello Vasca
Universale TPSVU

Codice	Riferimenti	Listino A	Listino B	Off.	Box
TPSVU		5,04 €	5,59 €	1	50



Cestello Univ.X
Pil.Autom 11/4
NSHB00

Codice	Riferimenti	Listino A	Listino B	Off.	Box
NSHB00		6,17 €	6,85 €	1	50



Kit Asta Per Saltarello
TPAST00000

Codice	Riferimenti	Listino A	Listino B	Off.	Box
TPAST00000		1,67 €	1,86 €	1	50



Asta Piletta Norton Zz
APN

Codice	Riferimenti	Listino A	Listino B	Off.	Box
APN		1,38 €	1,53 €	1	50



Piletta Doccia Da 11/4"
Sifoide PD11\4

Codice	Riferimenti	Listino A	Listino B	Off.	Box
PD11\4		9,07 €	10,07 €	1	50



Piletta Doccia Pozzetto
Pes. PDP11\4

Codice	Riferimenti	Listino A	Listino B	Off.	Box
PDP11\4		16,38 €	18,18 €	1	50



Piletta Tappo & Catena
11/4" S/T PTC11\4S

Codice	Riferimenti	Listino A	Listino B	Off.	Box
PTC1S		7,08 €	7,86 €	1	50
PTC11\4S		8,10 €	8,99 €	1	50



Piletta Tappo & Catena
11/4" PTC11\4

Codice	Riferimenti	Listino A	Listino B	Off.	Box
PTC1		6,38 €	7,08 €	1	50
PTC11\4		6,58 €	7,30 €	1	50



Pilettoni Pila 11/4"
PP11\4

Codice	Riferimenti	Listino A	Listino B	Off.	Box
PP11\4		17,20 €	19,09 €	1	50



Piletta Gattinara 11/4"
Ottone PG11\4

Codice	Riferimenti	Listino A	Listino B	Off.	Box
PG11\4	D. 11\4"	7,94 €	8,81 €	1	50



Piletta per Fontane a
cestello finitura ottone
lucido D. 1"1/4 PFCHB

Codice	Riferimenti	Listino A	Listino B	Off.	Box
PFCH		12,95 €	14,38 €	1	50
PFCHB		13,46 €	14,94 €	1	50



Piletta per Fontane
finitura bronzato D.
1"1/4 PFHB47

Codice	Riferimenti	Listino A	Listino B	Off.	Box
PFH47		14,27 €	15,84 €	1	50
PFHB47		15,18 €	16,85 €	1	50



PROCHBH Prolunga Ridotta
Cromata 11/4" F X1" M

Zz Ex Prc11\4X1

PROCHDHB Prolunga Ridotta
Cromata Fm
11/2"X11/4

Codice	Riferimenti	Listino A	Listino B	Off.	Box
PROCHBH	1"1/4X1"	5,14 €	5,70 €	1	50
PROCHDHB	1"1/2X1"1/4	5,14 €	5,70 €	1	50



RM114100 Riduzione Cromata
11/4" M X1" F

RM114100
RM1121140 Riduzione Cromata D.
11/2" M x 11/4" F
RM1121140

Codice	Riferimenti	Listino A	Listino B	Off.	Box
RM114100	1" 1/4 x 1"	5,14 €	5,70 €	1	50
RM1121140	1" 1/2 x 1" 1/4	6,33 €	7,02 €	1	50



Felix Piletta Click Clack
ABS 1"1/4 s t.p.

Codice	Riferimenti	Listino A	Listino B	Off.	Box
43114	ABS 1"1/4	3,29 €	3,65 €	1	50



Felix Piletta Click Clack
ABS 1"1/4 con t.p.

Codice	Riferimenti	Listino A	Listino B	Off.	Box
43114T	ABS 1"1/4	3,29 €	3,65 €	1	50



Colonna Scarico Vasca
11/2" CVA00

Codice	Riferimenti	Listino A	Listino B	Off.	Box
CVA00	Cromo	44,10 €	48,95 €	1	50



Colonna Vasca
Automatica Bian.
CVA04

Codice	Riferimenti	Listino A	Listino B	Off.	Box
CVA04	Bianca	38,10 €	42,29 €	1	50
CVA47	Bronzo	58,06 €	64,45 €	1	50



Sifone Sottovasca
11/4"X32 Redi
SSR11\4X32

Codice	Riferimenti	Listino A	Listino B	Off.	Box
SSR11\4X32	1"1\4X32	11,35 €	12,59 €	1	50
SSR11\2X40	1"1\2X40	12,04 €	13,36 €	1	50



Sifone Per Vasca Da
Bagno Orientabile Con
Uscita G1½
DS9000651E

Codice	Riferimenti	Listino A	Listino B	Off.	Box
DS9000651E	1"1\2X40	2,09 €	2,32 €	1	50



Raccordo Piombo Pvc Da 32
RPP32

Codice	Riferimenti	Listino A	Listino B	Off.	Box
RPP32	11/4"x32	6,06 €	6,73 €	1	50
RPP40	11/2"x40	6,06 €	6,73 €	1	50



Giunto Pp Bianco C/2 Ghiere
26X32Mm. 6004PL2632

Codice	Riferimenti	Listino A	Listino B	Off.	Box
6004PL2632	26X32	4,69 €	5,21 €	1	50
6004PL0032	32X32	4,29 €	4,76 €	1	50
6004PL3240	32X40	4,69 €	5,21 €	1	50
6004PL0040	40X40	4,69 €	5,21 €	1	50
6004PL0026	26X26	4,29 €	4,76 €	1	50



Raccordo Retto
11/4"X40 Arag.
RR11\4X40A

Codice	Riferimenti	Listino A	Listino B	Off.	Box
RR11\4X40A	11/4" Arancio	3,67 €	4,08 €	1	50
RR11\4X40G	11/4" Grigio	4,39 €	4,87 €	1	50



Raccordo Curvo
11/4"X32 RC11\4X32

Codice	Riferimenti	Listino A	Listino B	Off.	Box
RC11\4X32	11/4"X32	2,73 €	3,03 €	1	50
RC11\2X40	11/2"X40	3,70 €	4,11 €	1	50



Raccordo Retto
11/4"X32 RR11\4X32

Codice	Riferimenti	Listino A	Listino B	Off.	Box
RR11\4X32		2,73 €	3,03 €	1	50



Raccordo Curvo
11/4"X40 " RC11\4X40

Codice	Riferimenti	Listino A	Listino B	Off.	Box
RC11\4X40	11/4"X40	2,87 €	3,18 €	1	50



Sifone orinatoai uscita
var.D.40/50

Codice	Riferimenti	Listino A	Listino B	Off.	Box
SO950		8,57 €	9,51 €	1	50



Sifone piatto doccia
estensibile ATTACCO
40/50

Codice	Riferimenti	Listino A	Listino B	Off.	Box
SO160		3,46 €	3,85 €	1	50



Art. 300 Canotto in ottone cromato

Codice	Riferimenti	Listino A	Listino B	Off.	Pz
30026X25	26x25 mm	3,25 €	3,61 €	1	1
30026X30	26x30 mm	3,79 €	4,20 €	1	1
30030X25	30x25 mm	3,79 €	4,20 €	1	1
30030X30	30x30 mm	4,40 €	4,88 €	1	1
30032X25	32x25 mm	4,00 €	4,44 €	1	1
30032X30	32x30 mm	4,65 €	5,16 €	1	1
30040X25	40x25 mm	3,05 €	3,39 €	1	1
30040X30	40x30 mm	3,47 €	3,85 €	1	1
30026X100	26x100 mm	5,99 €	6,65 €	1	1
30030X100	30x100 mm	14,02 €	15,56 €	1	1
30032X100	32x100 mm	15,49 €	17,19 €	1	1
30040X100	40x100 mm	11,07 €	12,29 €	1	1



Art. 303 Canotto flessibile in rame cromato

Codice	Riferimenti	Listino A	Listino B	Off.	Pz
30326X25	26x25 cm	6,58 €	7,30 €	1	1
30326X30	26x30 cm	7,13 €	7,92 €	1	1
30330X25	30x25 cm	2,99 €	3,32 €	1	1
30330X30	30x30 cm	7,79 €	8,65 €	1	1
30332X25	32x25 cm	6,88 €	7,64 €	1	1
30332X30	32x30 cm	7,99 €	8,87 €	1	1



Rosone per canotto D. esterno D. 75

Codice	Riferimenti	Listino A	Listino B	Off.	Pz
R2600	D. 26 cromo	0,49 €	0,54 €	1	1
R3000	D. 30 cromo	0,48 €	0,54 €	1	1
R3200	D. 32 cromo	0,47 €	0,52 €	1	1
R4000	D. 40 cromo	0,83 €	0,92 €	1	1
R3047	D. 30 Bronzo	8,43 €	9,35 €	1	1
R3247	D. 32 Bronzo	8,43 €	9,35 €	1	1



Chiusino Ot. Cromo Vert. Faris 917

Codice	Riferimenti	Listino A	Listino B	Off.	Box
917		21,67 €	24,06 €	1	50



Art. 301 Canotto con battuta in ottone cromato

Codice	Riferimenti	Listino A	Listino B	Off.	Pz
30126X25	26x25 mm	3,29 €	3,65 €	1	1
30126X30	26x30 mm	3,83 €	4,25 €	1	1
30130X25	30x25 mm	2,42 €	2,69 €	1	1
30130X30	30x30 mm	4,48 €	4,97 €	1	1
30132X25	32x25 mm	4,05 €	4,49 €	1	1
30132X30	32x30 mm	4,69 €	5,21 €	1	1
30140X25	40x25 mm	3,23 €	3,58 €	1	1
30140X30	40x30 mm	8,95 €	9,94 €	1	1



Art. 305 Canotto 45° per cassette alta con tubo incassato

Codice	Riferimenti	Listino A	Listino B	Off.	Pz
305C30x24	30X240	4,79 €	5,31 €	1	1
305C30x28	30X280	5,44 €	6,04 €	1	1
305C30x32	30X320	6,20 €	6,88 €	1	1



Rosone per canotto D. esterno D. 75 L77XH14

Codice	Riferimenti	Listino A	Listino B	Off.	Pz
ROC00	Cromo	1,02 €	1,13 €	1	1
ROC47	Bronzo	0,92 €	1,02 €	1	1
ROC65	Rame	0,92 €	1,02 €	1	10



PIASTRA PASSO RAPIDO TONDA OTTONE

Codice	Riferimenti	Listino A	Listino B	Off.	Pz
2911P25	25 mm	4,54 €	5,03 €	1	1
2911P28	28 mm	4,49 €	4,98 €	1	10

Asta Piletta Norton Zz APN

Codice	Riferimenti	Listino A	Listino B	Off.	Box
APN		1,38 €	1,53 €	1	50



Chiusino Laterale Ottone Cr. CCCR

Codice	Riferimenti	Listino A	Listino B	Off.	Box
CCCR		4,47 €	4,96 €	1	50

SPHERA®
DOCCE & ACCESSORI

LA NUOVA DIMENSIONE DELL'ACQUA.

"SPHERA", rappresenta il nuovo parametro di comfort sotto la doccia, che soddisfa sia sul piano visivo che funzionale anche le più esigenti richieste di comodità ed estetica nella sala da bagno.



PANNELLI DOCCIA
COLONNE DOCCIA
ACCESSORI COLONNE
SOFFIONI/BRACCI
SALISCENDI
DOCCE
ACCESSORI

MONOGETTO
MULTIGETTO
SHUT-OFF
CUCINA
KIT DOCCE

Related Image of
Accessori Da

Accessori Bagno

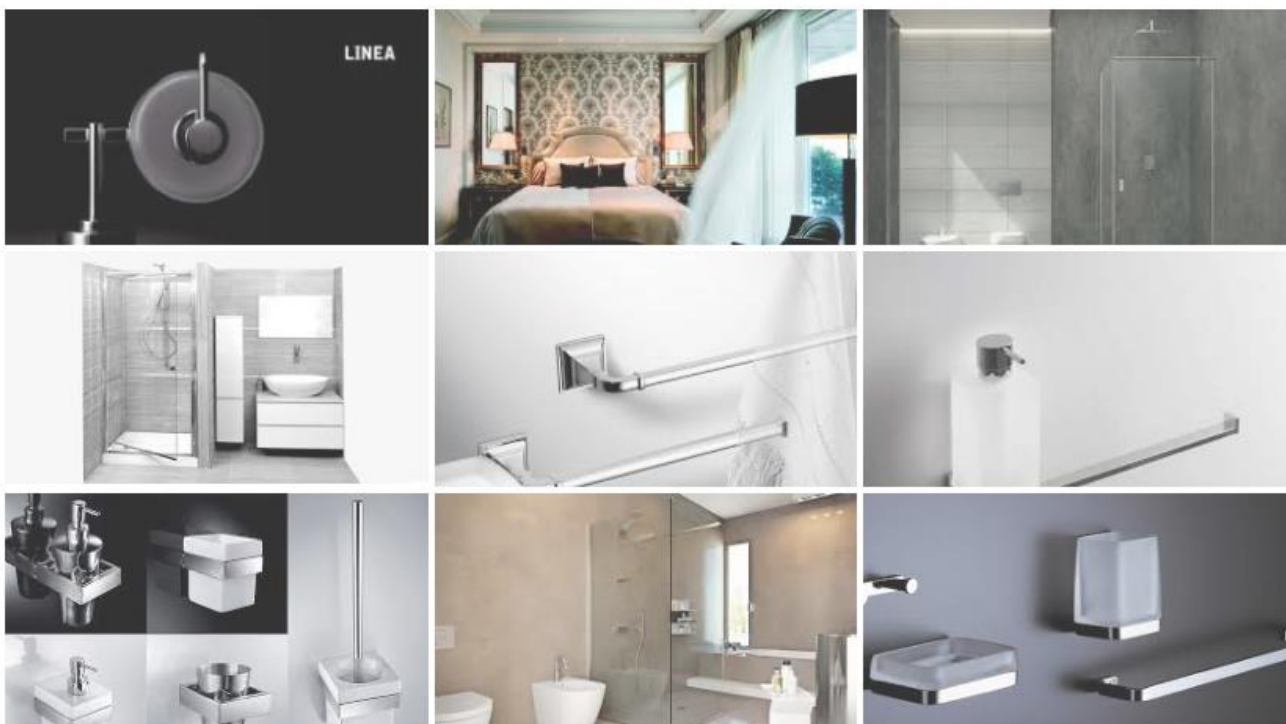



Colonna doccia in acciaio cromato Ø 22 mm con cursore in abs, deviatore e attacco per flessibile, supporti a muro scorrevoli posizionabili su fori già esistenti, completa di soffione ZIRCONE SD4205, doccia ZIRCONE DC5205, flessibile 150 cm e 60 cm D/A

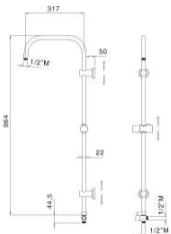

C17B45115CR

Codice	Riferimenti	Listino A	Listino B	Off.	Box
CDMC	Offerta 1 pz	74,42 €	82,60 €	1	5
CDMCx5	Offerta 5 pz	69,71 €	77,38 €	5	5



Colonna doccia in acciaio cromato Ø 22 mm cursore abs, deviatore e attacco per flessibile, supporti a muro scorrevoli posizionabili su fori già esistenti, soffione CHELSEA Ø 200 mm SD3922, doccia KIT MARINE DCKITMAR, flessibili 150 cm e 60 cm D/A

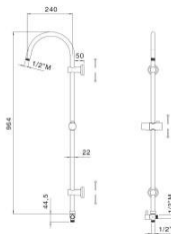

C19B449KMCR

Codice	Riferimenti	Listino A	Listino B	Off.	Box
C19B449KMCR	Offerta 1 pz	74,42 €	82,60 €	1	5
C19B449KMCRx5	Offerta 5 pz	69,71 €	77,38 €	5	5



SET C17/D CON DEVIATORE E ATTACCO FLEX, S/LISBONA E 20X20, 3,00 42,000 126,00 22 D/TRENDY, CURSORE IN ABS, FLEX D/A CM 150 E 60 - CROMO IN SCATOLA

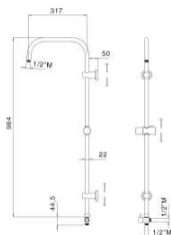

Codice	Riferimenti	Listino A	Listino B	Off.	Box
17D74214A0CR	Offerta 1 pz	94,26 €	104,63 €	1	5
17D74214A0CRx5	Offerta 5 pz	88,30 €	98,02 €	5	5



SET C17/D CON DEVIATORE E ATTACCO FLEX, S/ROMA E Ø 25, D/MINISTAR, CURSORE IN ABS, FLEX D/A CM 150 E 60 - CROMO IN SCATOLA

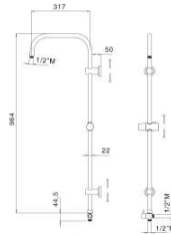

Codice	Riferimenti	Listino A	Listino B	Off.	Box
17D72304A0CR	Offerta 1 pz	94,26 €	104,63 €	1	5
17D72304A0CRx5	Offerta 5 pz	88,30 €	98,02 €	5	5



Saliscendi Europa 4 Getti Cr. SE4GC



Codice	Riferimenti	Listino A	Listino B	Off.	Box
SE4GC	Offerta 1 pz	26,57 €	29,49 €	1	5
SE4GCx5	Offerta 5 pz	24,40 €	27,08 €	5	5



Saliscendi NEOS Doccia AMBRA in abs 4 funzioni cromata con sistema anticalcare autopulente SL5N420T5CR



Codice	Riferimenti	Listino A	Listino B	Off.	Box
SL5N420T5CR	Offerta 1 pz	45,36 €	50,35 €	1	5
SL5N420T5CRx5	Offerta 5 pz	37,18 €	41,27 €	5	5



Saliscendi Completo Dalia DALIA



Codice	Riferimenti	Listino A	Listino B	Off.	Box
DALIA	Offerta 1 pz	34,02 €	37,76 €	1	5
DALIAx5	Offerta 5 pz	27,89 €	30,95 €	5	5



Saliscendi Asta Ellittica Con Portasapone E Doccetta KANDY



Codice	Riferimenti	Listino A	Listino B	Off.	Box
KANDY	Offerta 1 pz	45,93 €	50,98 €	1	5
KANDYx5	Offerta 5 pz	41,83 €	46,43 €	5	5



Saliscendi Cromato Per Doccia Serie
Tempesta Grohe
Asta Doccia 600Mm 27598001



Codice	Riferimenti	Listino A	Listino B	Off.	Box
27598001		62,84 €	69,75 €	1	5
27598001x5		57,71 €	64,05 €	5	5



Saliscendi Magic Confort Senza Asta
Regolabile SMC4GC



Codice	Riferimenti	Listino A	Listino B	Off.	Box
SMC4GC		26,57 €	29,49 €	1	5
SMC4GCx5		24,40 €	27,08 €	5	5



Set Doccia Cromo Palinuro
110E84100



Codice	Riferimenti	Listino A	Listino B	Off.	Box
110E84100	Offerta 1 pz	32,13 €	35,66 €	1	5
110E84100x5	Offerta 5 pz	27,89 €	30,95 €	5	5



Set Doccia Cromo Ischia
110E36100



Codice	Riferimenti	Listino A	Listino B	Off.	Box
110E36100	Offerta 1 pz	22,76 €	25,26 €	1	5
110E36100x5	Offerta 5 pz	19,75 €	21,92 €	5	5



New Saliscendi Docc.5 Getti Con
Porta Sapone ROSY



Codice	Riferimenti	Listino A	Listino B	Off.	Box
ROSY	Offerta 1 pz	28,35 €	31,47 €	1	5
ROSYx5	Offerta 5 pz	23,24 €	25,79 €	5	5



Saliscendi Lilia Completa LILIA



Codice	Riferimenti	Listino A	Listino B	Off.	Box
LILIA	Offerta 1 pz	34,02 €	37,76 €	1	5
LILIAx5	Offerta 5 pz	27,89 €	30,95 €	5	5



Saliscendi Cromato Per Doccia Serie
Tempesta Grohe
Asta Doccia 600Mm 27598001



Codice	Riferimenti	Listino A	Listino B	Off.	Box
27598001	Offerta 1 pz	62,84 €	69,75 €	1	5
27598001x5	Offerta 5 pz	57,71 €	64,05 €	5	5

SOFFIONE
Diametro di 16 cm.
con getto a pioggia dolce
+ BRACCIO
Lunghezza 36 cm.
+ DEVIATORE
A 3 vie che permette
di indirizzare il flusso
dell'acqua dalla doccia
al soffione e viceversa
+ FLESSIBILE
in acciaio inox
inossidabile

Kit Soffione Doccia Asta 24/25
59910



Codice	Riferimenti	Listino A	Listino B	Off.	Box
59910	Offerta 1 pz	17,01 €	18,88 €	1	5
59910x5	Offerta 5 pz	13,94 €	15,48 €	5	5



TRENDY



DC5056
Doccia monogetto
anticalcare in abs,
attacco 1/2
M



Codice	Off.	Listino A	Listino B
DC5056001CR	1	16,16 €	17,94 €
DC5056001CRx5	5	13,94 €	15,48 €

STAR



Doccia Star
Monoget.Antic.Ton
da DC5039



Codice	Off.	Listino A	Listino B
DC5039	1	14,41 €	15,99 €
DC5039x6	6	12,43 €	13,80 €

MINISTAR



Doccia MiniStar
Monoget.Antic.Ton
da



Codice	Off.	Listino A	Listino B
DC5213001CR	1	12,30 €	13,65 €
DC5213001CRx4	4	27,89 €	30,95 €

GLAMOUR



DC5048
Doccia monogetto
anticalcare in
ottone, attacco
1/2 M



Codice	Off.	Listino A	Listino B
DC5048	1	25,62 €	28,44 €
DC5048x5	5	58,09 €	64,48 €

ARTIST

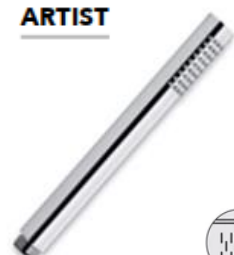

DC5055
Doccia monogetto
anticalcare in
ottone, attacco
1/2 M



Codice	Off.	Listino A	Listino B
DC5055009CR	1	23,57 €	26,16 €
DC5055009CRx5	5	53,45 €	59,33 €

QUADRA



Doccia monogetto
anticalcare in abs,
attacco 1/2
M



Codice	Off.	Listino A	Listino B
DC5023	1	12,30 €	13,65 €
DC5023x5	5	27,89 €	30,95 €



Doccetta Idromassaggio
Anticalcare Multigetto
Per Doccia Corallo
DC5083



Codice	Pz	Listino A	Listino B
DC5083	1	15,31 €	16,99 €
DC5083x5	5	14,06 €	15,61 €



Doccia 2 Funzioni Con
Getto A Cascata In Abs.
Gemma DC5084



Codice	Pz	Listino A	Listino B
DC5084	1	15,31 €	16,99 €
DC5084x5	5	14,06 €	15,61 €



Doccia AMBRA in abs 4 funzioni
cromata con sistema anticalcare
autopulente. DC5220001CR



Codice	Pz	Listino A	Listino B
DC5220001CR	1	7,59 €	8,43 €
DC5220001CRx5	5	6,97 €	7,74 €



Doccia Kit Marine Cromo
In Scatola Idromassaggio
DCKITM



Codice	Pz	Listino A	Listino B
DCKITM	1	11,58 €	12,85 €
DCKITMx5	5	10,67 €	11,85 €



Doccetta Primula Cromo
Ant. D1GC

ø 67 mm



Codice	Pz	Listino A	Listino B
D1GC	1	2,24 €	2,49 €
D1GCx5	5	2,07 €	2,30 €



Doccetta Aurora 5 Getti
Cromato AURORA



Codice	Pz	Listino A	Listino B
AURORA	1	6,55 €	7,27 €



Doccia Shanghai
Monogetto DCLED1

shanghai

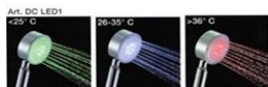

Codice	Pz	Listino A	Listino B
DCLED1	1	18,88 €	20,96 €
DCLED1x5	5	15,48 €	17,18 €



Doccia Tokio Monogetto
DCLED2



Codice	Pz	Listino A	Listino B
DCLED2	1	36,25 €	40,24 €
DCLED2x5	5	33,29 €	36,96 €



Doccia
Parrucchiere 2
Getti DC5003

parrucchiere

Codice	Pz	Listino A	Listino B
DC5003	1	16,57 €	18,40 €
DC5003x5	5	14,30 €	15,87 €



Doccia Cucina 2
Getti Bianca
DC5014B



Doccia Cucina 2
Getti Cromo "Xx"
DC5014CR



Doccia Aladino
Shut Off DC5028

Codice	Off.	Listino A	Listino B
DC5014B	1	12,15 €	13,49 €
DC5014Bx5	5	11,16 €	12,39 €

Codice	Off.	Listino A	Listino B
DC5014CR	1	4,81 €	5,34 €
DC5014CRx5	5	4,42 €	4,90 €

Codice	Off.	Listino A	Listino B
DC5028	1	3,80 €	4,22 €

Doccetta Retta Ec. Bianca DREB



DOCCETTA DOCCIA CON CURVETTA PER FORCELLA CLASSICA
Doccia con curvetta per forcella classica DCEN



Doccia Salome' DC5009

Codice	Pz	Listino A	Listino B
DREB	1	2,70 €	3,00 €
DREN	1	2,70 €	3,00 €

Codice	Pz	Listino A	Listino B
DCEN	1	3,29 €	3,65 €

Codice	Pz	Listino A	Listino B
DC5009	1	18,95 €	21,04 €



Soffione Magic
Anticalcare SD4072



Soffione Ninfea 3 Getti
Anticalcare Cromato
SD4062



Doccia Shut Off Con
Fermo Leva Nera
DC5035N

**Doccia
"SHUT " OFF**

Codice	Rif.	Listino A	Listino B
SD4072	1	4,30 €	4,77 €

Codice	Pz	Listino A	Listino B
SD4062	1	14,93 €	16,57 €

Codice	Rif.	Listino A	Listino B
DC5035N	Nera	4,24 €	4,70 €
DC5035B	Bian.	5,06 €	5,62 €



Soffione Iris
Anticalcare Sac.
S1GA



Soffione Standard
1/2" SS



Soffione Gardenia
5 Getti SD4020

Codice	Off.	Listino A	Listino B
S1GA	1	4,34 €	4,81 €

Codice	Off.	Listino A	Listino B
SS	1	5,31 €	5,89 €

Codice	Off.	Listino A	Listino B
SD4020	1	8,93 €	9,91 €



Soffione A
Campana
Anticalcare
SD4075



Soffione
Idromassaggio
Muoltigettti
Easyclean Pesante
Cromato Lucido
0893CR



Soffione
Idromassaggio
Muoltigettti
Pesante Cromato
Lucido 0892CR

FLEXTON

FLEXTON

Codice	Off.	Listino A	Listino B
SD4075	1	6,89 €	7,65 €

Codice	Off.	Listino A	Listino B
0893CR	1	10,72 €	11,90 €

Codice	Off.	Listino A	Listino B
0892CR	1	19,11 €	21,21 €

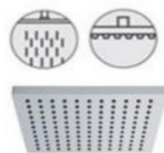

Soffione Derby 20X20
SD4914

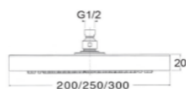

Codice	Riferimenti	Listino A	Listino B	Off.	Box
SD4914	cm.20	28,68 €	31,83 €	1	12
SD4924	cm.25	64,13 €	71,18 €	1	12
SD4934	cm.30	86,17 €	95,65 €	1	12



Soffione Minimale In Acciaio
Anticalcare Import Quadrato
10X10 S-1040Q

Import Export

Codice	Riferimenti	Listino A	Listino B	Off.	Box
S-1040Q	10x10	5,39 €	5,98 €	1	12
S-1540Q	15x15	11,34 €	12,59 €	1	12
S-2040Q	20x20	17,01 €	18,88 €	1	12
S-2540Q	25x25	25,52 €	28,32 €	1	12



Soffione Tondo 20X20
Chelsea SD3922

Codice	Riferimenti	Listino A	Listino B	Off.	Box
SD3922	cm.20	20,16 €	22,38 €	1	12
SD3925	cm.25	42,91 €	47,63 €	1	12
SD3930	cm.30	65,86 €	73,11 €	1	12



Soffione Minimale In Acciaio
Anticalcare Import Tondo D.
10 Zx S-1040T

Import Export

Codice	Riferimenti	Listino A	Listino B	Off.	Box
S-1040T	10x10	5,67 €	6,29 €	1	12
S-1540T	15x15	11,34 €	12,59 €	1	12
S-2040T	20x20	17,01 €	18,88 €	1	12
S-2540T	25x25	25,52 €	28,32 €	1	12



Soffione ROMA "E" anticalcare
in acciaio inox 304 diametro Ø
200-250-300-400 mm Nero
Opaco



Codice	Riferimenti	Listino A	Listino B	Off.	Box
SD3310NO	10x10	0,00 €	0,00 €	1	12
SD3315NO	15x15	0,00 €	0,00 €	1	12
SD3320NO	20x20	78,90 €	87,58 €	1	12
SD3325NO	25x25	119,89 €	133,08 €	1	12
SD3330NO	30x30	161,91 €	179,72 €	1	12
SD3340NO	40x40	231,59 €	257,06 €	1	12



Soffione ROMA "E" anticalcare
in acciaio inox 304 diametro Ø
200-250-300-400 mm



Codice	Riferimenti	Listino A	Listino B	Off.	Box
SD3310	10x10	22,54 €	25,02 €	1	12
SD3315	15x15	26,64 €	29,57 €	1	12
SD3320	20x20	32,51 €	36,09 €	1	12
SD3325	25x25	40,48 €	44,94 €	1	12
SD3330	30x30	53,13 €	58,98 €	1	12
SD3340	40x40	174,20 €	193,37 €	1	12



Soffione LISBONA "E" anticalcare
in
acciaio inox 304 Nero Opaco



Codice	Riferimenti	Listino A	Listino B	Off.	Box
SD3410NO	10x10	0,00 €	0,00 €	1	12
SD3415NO	15x15	0,00 €	0,00 €	1	12
SD3420NO	20x20	91,21 €	101,24 €	1	12
SD3425NO	25x25	130,15 €	144,46 €	1	12
SD3430NO	30x30	169,09 €	187,69 €	1	12
SD3440NO	40x40	243,90 €	270,73 €	1	12



Soffione LISBONA "E" anticalcare
in
acciaio inox 304
200x200-250x250-300x300 mm



Codice	Riferimenti	Listino A	Listino B	Off.	Box
SD3410	10x10	25,62 €	28,44 €	1	12
SD3415	15x15	30,74 €	34,13 €	1	12
SD3420	20x20	29,10 €	32,30 €	1	12
SD3425	25x25	41,75 €	46,34 €	1	12
SD3430	30x30	54,40 €	60,39 €	1	12
SD3440	40x40	185,37 €	205,76 €	1	12



35+soffione doccia SD3420E +flessibile inPVC SILVER CM 150

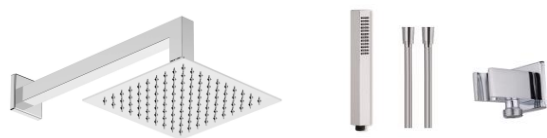

Codice	Riferimenti	Listino A	Listino B	Off.	Box
K974577356R	1	110,32 €	122,46 €	1	5

35+soffione doccia SD3320E +flessibile inPVC SILVER CM 150 + p



Codice	Riferimenti	Listino A	Listino B	Off.	Box
K971467213R	1	93,62 €	103,92 €	1	5

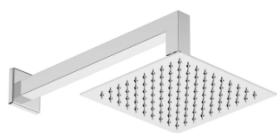

Set doccia quadro 2 pezzi
composto da : braccio doccia
BD6057 CM 35+ soffione doccia
SD3420E CP5735743CR

Codice	Riferimenti	Listino A	Listino B	Off.	Box
CP5735743CR	1	72,37 €	80,33 €	1	5



Set doccia tondo 2 pezzi
composto da : braccio doccia
BD6046 CM 35+ soffione doccia
SD3320E CP4635713CR

Codice	Riferimenti	Listino A	Listino B	Off.	Box
CP4635713CR	1	56,93 €	63,19 €	1	5



Braccio Doccia Sphera 6037
25 Cm BD6037253CR

Codice	Riferimenti	Listino A	Listino B	Off.	Box
BD6037253CR	cm.25	12,25 €	13,59 €	1	5
BD6037303CR	cm.30	14,03 €	15,58 €	1	5
BD6037353CR	cm.35	14,42 €	16,01 €	1	5
BD6037403CR	cm.40	15,31 €	16,99 €	1	5



Braccio Doccia 25 Cm Import
DGO-08525

Codice	Riferimenti	Listino A	Listino B	Off.	Box
DGO-08525	cm.25	5,44 €	6,04 €	1	5
DGO-08630	cm.30	5,67 €	6,29 €	1	5
DGO-08735	cm.35	5,67 €	6,29 €	1	5
DGO-08740	cm.40	Arrivo	Arrivo	1	5



Braccio Doccia Lusso Sezione
Quadrata In Scatola
BD6042003CR

Codice	Riferimenti	Listino A	Listino B	Off.	Box
BD6042003CR	1	56,85 €	63,11 €	1	5
BD6042003CRx5	5	52,22 €	57,96 €	1	5



Braccio Doccia Lusso Cm.35
BD6048CR35

Codice	Riferimenti	Listino A	Listino B	Off.	Box
BD6048CR35	1	61,09 €	67,81 €	1	5
BD6048CR35x5	5	56,11 €	62,28 €	1	5



Kit Braccio Doccia Con
Soffione Serie Lux 4010CR

Codice	Riferimenti	Listino A	Listino B	Off.	Box
4010CR	1	30,36 €	33,70 €	1	5
4010CRx5	5	27,89 €	30,95 €	1	5



Kit Braccio Doccia Con
Soffione Serie Lux 4001CR

Codice	Riferimenti	Listino A	Listino B	Off.	Box
4001CR	1	30,36 €	33,70 €	1	5
4001CRx5	5	27,89 €	30,95 €	1	5



Kit Braccio Doccia Con
Soffione Serie Lux Anticalcare
4002CR

Codice	Riferimenti	Listino A	Listino B	Off.	Box
4002CR	1	30,36 €	33,70 €	1	5
4002CRx5	5	27,89 €	30,95 €	1	5



Kit Braccio Doccia Con
Soffione Serie Lux Maxi
Perfecta 4003CR

Codice	Riferimenti	Listino A	Listino B	Off.	Box
4003CR	1	30,36 €	33,70 €	1	5
4003CRx5	5	27,89 €	30,95 €	1	5



Duplex Glamour Fisso
DP3064



Duplex Arte Fisso
DP3052



RUIS12
Rubinetto per idroscopino in
ottone 1/2 M x 1/2
M con supporto doccia
(acqua fredda) RUIS12

Codice	Pz	Listino A	Listino B
DP3064	1	35,04 €	38,90 €
DP3064x5	5	31,54 €	35,01 €

Codice	Pz	Listino A	Listino B
DP3052	1	31,87 €	35,37 €
DP3052x5	5	28,68 €	31,83 €

Codice	Pz	Listino A	Listino B
RUIS12	1	21,26 €	23,60 €
RUIS12x5	5	19,14 €	21,24 €



Gomito Saliscendi Mm
1/2" C.Ros GS1\2



Preso acqua in ottone
serie Glamour attacco
1/2" MM PA3160003CR



Preso acqua in ottone
modello Arte attacco 1/2"
MM PA3150003CR

Codice	Pz	Listino A	Listino B
GS1\2	1	1,87 €	2,08 €
GS1\2x20	20	1,72 €	1,91 €

Codice	Pz	Listino A	Listino B
PA3160003CR	1	19,99 €	22,19 €

Codice	Pz	Listino A	Listino B
PA3150003CR	1	4,10 €	4,55 €



Duplex Esterno Abs
DP3033



Duplex Esterno Forcellino
DP3036



Duplex Esterno Fuso
DP3034

Codice	Pz	Listino A	Listino B
DP3033	1	1,08 €	1,20 €

Codice	Pz	Listino A	Listino B
DP3036	1	4,14 €	4,60 €

Codice	Pz	Listino A	Listino B
DP3034	1	5,72 €	6,34 €



Flex Doccia Da 150 Ff
FD150



Flex Doccia 150 Conico
FD150C



Flex Monoforo 120
Conico 1/2" Cono 3/8"
Maschio FM120C

Codice	Pz	Listino A	Listino B
FD150	150	3,08 €	3,42 €
FD200	200	4,35 €	4,83 €

Codice	Pz	Listino A	Listino B
FD150C	150	3,68 €	4,08 €
FD200C	200	4,54 €	5,03 €

Codice	Pz	Listino A	Listino B
FM120C	1	5,04 €	5,59 €



Flex Doccia Estensibile
Scatola 150-200 Conico
FDE200S



Flessibile doccia doppio
strato in silicone 1/2 F
antitorsione cm 150



Flessibile in PVC con
spirale metallica cromata
con attacchi universali
1/2 F

Codice	Pz	Listino A	Listino B
FDE200S	1	6,53 €	7,25 €

Codice	Pz	Listino A	Listino B
FLC155901BO	Bianco	15,37 €	17,06 €
FLC155901NO	Nero	15,37 €	17,06 €

Codice	Pz	Listino A	Listino B
FLP155401CR	150	6,15 €	6,83 €
FLP205401CR	200	7,17 €	7,96 €

LINEA
ARTE

Accessori Bagno

SPHERA®
DOCCE & ACCESSORI



PORTA SPAZZOLINO
IN OTTONE

Codice	Riferimenti	Listino A	Listino B	Off.	Box
ACOMSP	1	32,26 €	35,81 €	1	5



PORTA ROTOLO IN
OTTONE

Codice	Riferimenti	Listino A	Listino B	Off.	Box
ACOMSA	1	32,26 €	35,81 €	1	5



PORTA ROTOLO IN
OTTONE

Codice	Riferimenti	Listino A	Listino B	Off.	Box
ACOMSC	1	51,10 €	56,72 €	1	5



PORTA ROTOLO IN
OTTONE

Codice	Riferimenti	Listino A	Listino B	Off.	Box
ACOMPS30	1	40,08 €	44,49 €	1	5



PORTA ROTOLO IN
OTTONE

Codice	Riferimenti	Listino A	Listino B	Off.	Box
ACOMPS40	1	48,39 €	53,72 €	1	5



PORTA ROTOLO IN
OTTONE

Codice	Riferimenti	Listino A	Listino B	Off.	Box
ACOMPS58	1	49,09 €	54,49 €	1	5



Art. ACOMRO

PORTA ROTOLO IN
OTTONE

Codice	Riferimenti	Listino A	Listino B	Off.	Box
ACOMRO	1	26,30 €	29,19 €	1	5



PORTA ROTOLO IN
OTTONE

Codice	Riferimenti	Listino A	Listino B	Off.	Box
ACOMRO	1	26,30 €	29,19 €	1	5



PORTA ROTOLO IN
OTTONE

Codice	Riferimenti	Listino A	Listino B	Off.	Box
ACOMDI	1	38,07 €	42,26 €	1	5



PORTA ROTOLO IN
OTTONE

Codice	Riferimenti	Listino A	Listino B	Off.	Box
RIACMSA	1	5,21 €	5,78 €	1	5



PORTA ROTOLO IN
OTTONE

Codice	Riferimenti	Listino A	Listino B	Off.	Box
RIACMSP	1	5,21 €	5,78 €	1	5



Art. ACOMRO



Art. ACOGSP

PORTA SPAZZOLINO
IN OTTONE

Codice	Riferimenti	Listino A	Listino B	Off.	Box
ACOGSP	1	33,57 €	37,26 €	1	5



Art. ACOGSA

PORTA SAPONE IN
OTTONE

Codice	Riferimenti	Listino A	Listino B	Off.	Box
ACOGSA	1	32,89 €	36,51 €	1	5



Art. ACOGSC

PORTA SCOPINO IN
OTTONE

Codice	Riferimenti	Listino A	Listino B	Off.	Box
ACOGSC	1	54,10 €	60,05 €	1	5



RICAMBIO BICCHERE
VETRO

Codice	Riferimenti	Listino A	Listino B	Off.	Box
RIACGSP	1	5,21 €	5,78 €	1	5



RICAMBIO
VASCHETTA SAPONE
VETRO

Codice	Riferimenti	Listino A	Listino B	Off.	Box
RIACSGA	1	5,21 €	5,78 €	1	5



Art. ACOGRO

PORTA ROTOLO IN
OTTONE

Codice	Riferimenti	Listino A	Listino B	Off.	Box
ACOGRO	1	26,06 €	28,93 €	1	5



Art. ACOGGA

APPENDI ABITO IN
OTTONE

Codice	Riferimenti	Listino A	Listino B	Off.	Box
ACOGGA	1	22,04 €	24,47 €	1	5



Art. ACOGPS

APPENDI
ACIUGAMANO IN
OTTONE CM. 40

Codice	Riferimenti	Listino A	Listino B	Off.	Box
ACOGPS40	1	47,09 €	52,27 €	1	5



Art. ACOGPS

APPENDI
ACIUGAMANO IN
OTTONE CM. 59

Codice	Riferimenti	Listino A	Listino B	Off.	Box
ACOGPS60	1	52,10 €	57,83 €	1	5



Art. ACOGPS



Art. ACOGSP



Art. ACOGSA



Art. ACOGSC



Art. ACOGGA



Art. ACOGRO



ANGOLIERE e PIANTANE

Accessori Bagno



Angoliera Porta Oggetti In Ottone ACOAN1

Art. ACOAN1

ACOAN1



Angoliera Porta Oggetti In Ottone ACOANH

Art. ACOANH

ACOANH



Angoliera Porta Oggetti In Ottone ACOAN2

Art. ACOAN2

ACOAN2

Codice	Pz	Listino A	Listino B
ACOAN1	1	25,16 €	27,93 €

Codice	Pz	Listino A	Listino B
ACOANH	1	36,07 €	40,04 €

Codice	Pz	Listino A	Listino B
ACOAN2	1	77,15 €	85,64 €



Portasalviette Da Pavimento ACPIA2

Art. ACPIA2
ACPIA2

Codice	Pz	Listino A	Listino B
ACPIA2	1	227,44 €	252,46 €



Portasalviette Da Pavimento ACPIA1

Art. ACPIA1
ACPIA1

Codice	Pz	Listino A	Listino B
ACPIA1	1	155,71 €	172,84 €



Angoliera Porta Oggetti In Ottone ACOAN3

Art. ACOAN3
ACOAN3

Codice	Pz	Listino A	Listino B
ACOAN3	1	115,22 €	127,90 €



Porta Oggetti In Ottone 2 Ripiani ACOAPP

Art. ACOAPP
ACOAPP

Codice	Pz	Listino A	Listino B
ACOAPP	1	108,21 €	120,11 €

Tube Estens.Bianco 120->200cm 751587



Tube estensibile 120->200 cm.

Codice	Pz	Listino A	Listino B
751587	1	3,91 €	4,34 €

Sostegno X Tenda Doccia Acciaio 80x80x80 750498



80x80x80cm

Codice	Pz	Listino A	Listino B
750498	1	8,99 €	9,98 €



Tubo Doccia 80 X 80 Bianco 110715002

110715002



Codice	Pz	Listino A	Listino B
110715002	1	12,10 €	13,43 €



Hk Tenda Doccia Mod. Hello 180X200cm HLK00TD0HLL00

HLK00TD0HLL00

Codice	Pz	Listino A	Listino B
HLK00TD0HLL00	1	8,38 €	9,30 €



Hk Tenda Doccia Mod. Sweet 180X200cm HLK00TD0SWT00

HLK00TD0SWT00

Codice	Pz	Listino A	Listino B
HLK00TD0SWT00	1	8,38 €	9,30 €

Tenda Doccia Strisce 180X180 2 Ass. 645362



100% POLIESTERE GANCI INCLUSI 180x180cm

Codice	Pz	Listino A	Listino B
645362	1	7,26 €	8,06 €
645362x5	5	6,69 €	7,43 €

Tenda Doccia Pallini 180X180 2 Ass. 645363



100% POLIESTERE GANCI INCLUSI 180x180cm

Codice	Pz	Listino A	Listino B
645363	1	7,66 €	8,50 €
645363x5	5	6,69 €	7,43 €

Tenda Doccia 180X180 2 Ass. 645364



100% POLIESTERE GANCI INCLUSI 180x180cm

Codice	Pz	Listino A	Listino B
645364	1	7,26 €	8,06 €
645364x5	5	7,06 €	7,84 €



Cestino Carol Triplo Cromato ACC13142



Cestino Carol Doppio Cromato ACC13141



Cestino Carol Singolo Cromato ACC13140

Codice	Pz	Listino A	Listino B
ACC13142	1	15,12 €	16,78 €

Codice	Pz	Listino A	Listino B
ACC13141	1	12,60 €	13,99 €

Codice	Pz	Listino A	Listino B
ACC13140	1	10,12 €	11,23 €

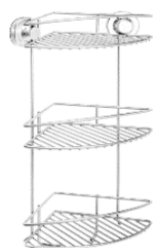

SHOWER LOCK ANGOLARE DOCCIA TRIPLO SATINATO 101D14101



Angoliera Melanie Doppia Cromato ACC13146



Angoliera Melanie Singola Cromato ACC13150

Codice	Pz	Listino A	Listino B
101D14101	1	31,68 €	35,16 €

Codice	Pz	Listino A	Listino B
ACC13146	1	12,60 €	13,99 €

Codice	Pz	Listino A	Listino B
ACC13150	1	10,08 €	11,19 €



Cestello Grip 105G94100



Angolare Doccia Bianco Oasi 101C17004



Angolare Doccia Grip 105G96100



Codice	Pz	Listino A	Listino B
105G94100	1	20,59 €	22,85 €

Codice	Pz	Listino A	Listino B
101C17004	1	8,06 €	8,95 €

Codice	Pz	Listino A	Listino B
105G96100	1	24,39 €	27,08 €



Set Accessori Bagno Metaform Serie Otto/One 101757100



Kit Wind 4 Pezzi Cromo 105L23100



Kit Wind 8 Pezzi Cromo 101L02100



Codice	Pz	Listino A	Listino B
101757100	1	84,42 €	93,71 €

Codice	Pz	Listino A	Listino B
105L23100	1	47,88 €	53,15 €

Codice	Pz	Listino A	Listino B
101L02100	1	90,72 €	100,70 €



Porta Scopino Da Terra Cromo 101118100



Kit Linea 9 Pezzi Bianco 101331004



Kit Linea 4 Pezzi Cromo 110A46100



Codice	Pz	Listino A	Listino B
101118100	1	11,84 €	13,15 €

Codice	Pz	Listino A	Listino B
101331004	1	60,48 €	67,13 €

Codice	Pz	Listino A	Listino B
110A46100	1	45,36 €	50,35 €



nuova gamma di sedili per WC

TUTTI I SEDILI IN RESINA "TERMOINDURENTE"
SONO DISPONIBILI CON CERNIERA RALLENTATA

Cerniere collaudate resistenti e facili da montare. Una comodità assoluta, un semplice gesto per chiudere automaticamente il sedile senza sbattere, senza rumori fastidiosi e senza schiacciarsi le dita.



COPRIWATER IN TERMOINDURENTE

SAT9

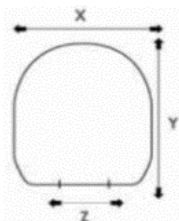

X ⇒ 35,5
Y ⇒ 39,5
Z ⇒ 16



Prezzo Unitario

Sat 9 Copriwater Termoindurente SAT9

Codice	Riferimenti	Listino A	Listino B	Off.	Box
SAT9	1	72,11 €	80,05 €	1	10
SAT9x5	5	66,23 €	73,51 €	1	10

Elenco di Alcuni Modelli Adattabili

Azienda	Modelli	Azienda	Modelli
FALERI	F.30		
JUMBO	EGO		
HIDRA	ANGELA		

Visiona l'elenco generale a Pag.

180-185

Kg. 2,00 circa volgente

SAT10

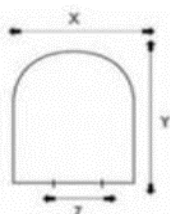
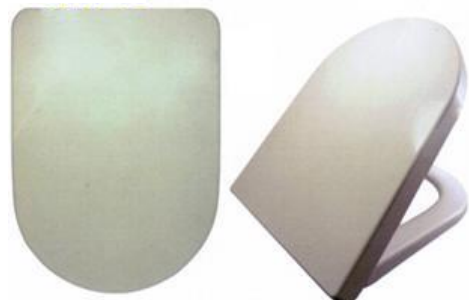

X ⇒ 36
Y ⇒ 45,5
Z ⇒ 17



Prezzo Unitario

Sedile Soft Close Sat 10 SAT10

Codice	Riferimenti	Listino A	Listino B	Off.	Box
SAT10	1	72,11 €	80,05 €	1	10
SAT10x5	5	66,23 €	73,51 €	1	10

Elenco di Alcuni Modelli Adattabili

Azienda	Modelli	Azienda	Modelli
KERASAN	FLO52	AZZURRA	NUVOLA
OLIMPIA	NICOLE	CIELO	SMILE
GLOBO	OPEN SPACE CONCEPT	FLAMINIA	LINK
CATALANO	SISTEMA C52	HATRIA	DAYTIME
CATALANO	C52	INCEA	SARA
CATALANO	C54	NERO CERAMICA	GENESI

Visiona l'elenco generale a Pag.

180-185

Kg. 2,70 circa volgente

SAT11

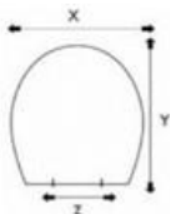
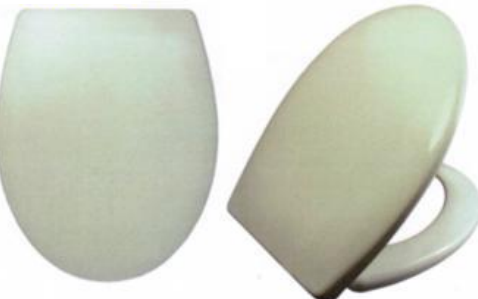

X ⇒ 36,5
Y ⇒ 44
Z ⇒ 14,5



Prezzo Unitario

Sedile Soft Close Sat 11 SAT11

Codice	Riferimenti	Listino A	Listino B	Off.	Box
SAT11	1	61,99 €	68,81 €	1	10
SAT11x5	5	56,93 €	63,19 €	1	10

Elenco di Alcuni Modelli Adattabili

Azienda	Modelli	Azienda	Modelli
CIELO	EURO	CATALANO	LUCE
CIELO	LIGHT		
CESABO	EXEL		
GSI	CLIZIA		
ALTHEA	CENTO		
ALTHEA	FLY		

Visiona l'elenco generale a Pag.

180-185

Kg. 2,20 circa Avvolgente

SAT12 48/54

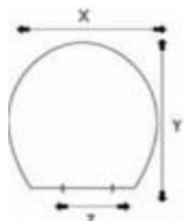
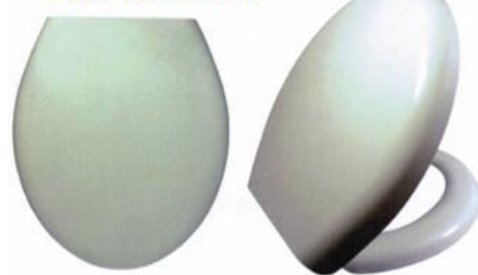

X ⇒ 37
Y ⇒ 45
Z ⇒ 18



Prezzo Unitario

Sedile Soft Close Sat 12 Full 48 SAT12

Codice	Riferimenti	Listino A	Listino B	Off.	Box
SAT12	1	69,08 €	76,68 €	1	10
SAT12x5	5	63,44 €	70,42 €	1	10

Elenco di Alcuni Modelli Adattabili

Azienda	Modelli	Azienda	Modelli
AZZURRA	FULL48		
AZZURRA	FULL54		
ESEDRA	POING		

Visiona l'elenco generale a Pag.

180-185

Kg. 2,10 circa volgente



Sedile Soft Close Sat 13 SAT13

Codice	Riferimenti	Listino A	Listino B	Off.	Box
SAT13	1	69,08 €	76,68 €	1	10
SAT13x5	5	63,44 €	70,42 €	1	10

Elenco di Alcuni Modelli Adattabili

Azienda	Modelli	Azienda	Modelli
AZZURRA	DIANA	CIELO	MEDEA
AZZURRA	AFRODITE	CIELO	FLORENCE
AZZURRA	MIDAS	EOS	CLIO
JUMBO	ARETONA	FALERI	ADRIA SOSP.
FALERI	ADRIA	FALERI	ADRIA MB
CESAME	ARETUSA		

Visiona l'elenco generale a Pag. 180-185

Kg. 2,20 circa volgente

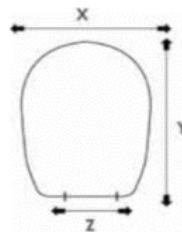

X ⇨ 36
Y ⇨ 47,5
Z ⇨ 14

Prezzo Unitario

SAT13

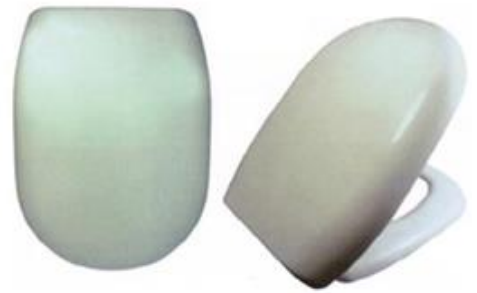

Sedile Soft Close Sat 14 SAT14

Codice	Riferimenti	Listino A	Listino B	Off.	Box
SAT14	1	70,85 €	78,64 €	1	10
SAT14x5	5	65,07 €	72,22 €	1	10

Elenco di Alcuni Modelli Adattabili

Azienda	Modelli	Azienda	Modelli
ALTHEA	HOLA		UNIVERSALE
GLOBO	LEI		
GLOBO	SKY		
AZZURRA	GIOVE		
HATRIA	ERIKA		

Visiona l'elenco generale a Pag. 180-185

Kg. 2,00 circa volgente

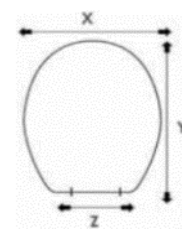

X ⇨ 37,5
Y ⇨ 44
Z ⇨ 14

Prezzo Unitario

SAT14

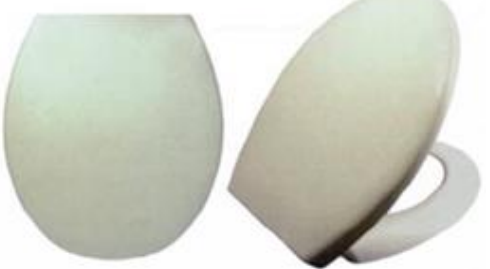

Sedile Soft Close Sat 15 SAT15

Codice	Riferimenti	Listino A	Listino B	Off.	Box
SAT15	1	63,26 €	70,22 €	1	10
SAT15x5	5	58,09 €	64,48 €	1	10

Elenco di Alcuni Modelli Adattabili

Azienda	Modelli	Azienda	Modelli
ROCA	POLO		
SENESI	DONATELLO		
POZZI GINORI	OLIBRI		
ROCA	VICTORIA		

Visiona l'elenco generale a Pag. 180-185

Kg. 2,10 circa volgente

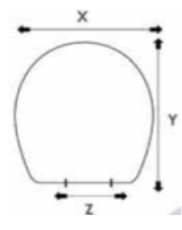

X ⇨ 37
Y ⇨ 44
Z ⇨ 14

Prezzo Unitario

SAT15



Sedile Soft Close Sat 16 SAT16

Codice	Riferimenti	Listino A	Listino B	Off.	Box
SAT16	1	73,38 €	81,45 €	1	10
SAT16x5	5	67,39 €	74,80 €	1	10

Elenco di Alcuni Modelli Adattabili

Azienda	Modelli	Azienda	Modelli
ALTHEA	MARION	CESABO	ENDURANCE
AXA	CLIVIA	CESAME	SINTESI
AXA	CLIVIA SOSP.	CIELO	CELIA
AZZURRA	ELIOS	DISEGNO CERAMICA	GIULIA
AZZURRA	ELIOS PLUS	DOLOMITE	CLODIA
CATALANO	NEW SFERA	ESEDRA	MIX

Visiona l'elenco generale a Pag. 180-185

Kg. 2,10 circa Avvolgente

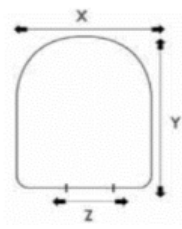

X ⇨ 36,5
Y ⇨ 45,5
Z ⇨ 17

Prezzo Unitario

SAT16

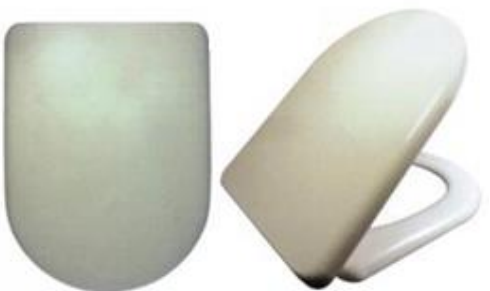

SAT17

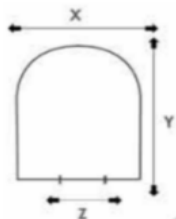

X ⇒ 36
Y ⇒ 42
Z ⇒ 17.5



Prezzo Unitario

Sedile Soft Close Sat 17 SAT17

Codice	Riferimenti	Listino A	Listino B	Off.	Box
SAT17	1	73,38 €	81,45 €	1	10
SAT17x5	5	67,39 €	74,80 €	1	10

Elenco di Alcuni Modelli Adattabili

Azienda	Modelli	Azienda	Modelli
FLAMINIA	MINI LINK		
KERASAN	MINI FLO 48		
AXA	AXA ONE		

Visiona l'elenco generale a Pag.

180-185

Kg. 2,70 circa volante

SAT18

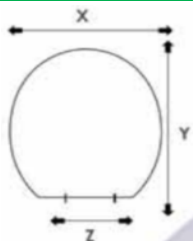

X ⇒ 36,5
Y ⇒ 40
Z ⇒ 13



Prezzo Unitario

Sedile Soft Close Sat 18 SAT18

Codice	Riferimenti	Listino A	Listino B	Off.	Box
SAT18	1	72,11 €	80,05 €	1	10
SAT18x5	5	66,23 €	73,51 €	1	10

Elenco di Alcuni Modelli Adattabili

Azienda	Modelli	Azienda	Modelli
Pozzi Ginori	Panda	Pozzi Ginori	Colibri 2
Roca	Polo		
Roca	Victoria		
Simas	Arcade		

Visiona l'elenco generale a Pag.

180-185

SAT19

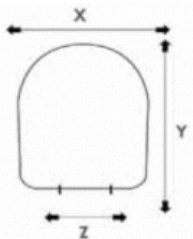

X ⇒ 35,2
Y ⇒ 46
Z ⇒ 18



Prezzo Unitario

Sedile Soft Close Sat 19 SAT19

Codice	Riferimenti	Listino A	Listino B	Off.	Box
SAT19	1	73,38 €	81,45 €	1	10
SAT19x5	5	67,39 €	74,80 €	1	10

Elenco di Alcuni Modelli Adattabili

Azienda	Modelli	Azienda	Modelli
Althea	Ring	Azzurra	Midas
Astra	Gemma	Azzurra	Pratica
Axa	Clivia	Cesabo	Endurance
Azzurra	Afrodite	Cesame	Aretusina
Azzurra	Elios	Cesame	Sintesi
Azzurra	Elios Plus	Cielo	Celia

Visiona l'elenco generale a Pag.

180-185

SAT20

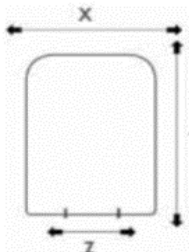

X ⇒ 36
Y ⇒ 48,5
Z ⇒ 18



Prezzo Unitario

Sedile Soft Close Sat 20 SAT20

Codice	Riferimenti	Listino A	Listino B	Off.	Box
SAT20	1	72,11 €	80,05 €	1	10
SAT20x5	5	66,23 €	73,51 €	1	10

Elenco di Alcuni Modelli Adattabili

Azienda	Modelli	Azienda	Modelli
Nero Ceramica	Aliseo		
Pozzi Ginori	Novecento		

Visiona l'elenco generale a Pag.

180-185

Sedile Soft Close Sat 21 SAT21

Codice	Riferimenti	Listino A	Listino B	Off.	Box
SAT21	1	72,11 €	80,05 €	1	10
SAT21x5	5	66,23 €	73,51 €	1	10

Elenco di Alcuni Modelli Adattabili

Azienda	Modelli	Azienda	Modelli
Cesame	Fenice	G.S.I	Modo
Disegno Ceramica	Ovo	Rak	Venice
Dolomite	Dahlia		
Dolomite	Novella		
Dolomite	Sweet Life		
Esedra	Basic		

Visiona l'elenco generale a Pag.

180-185

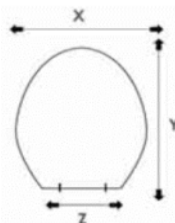
**SAT21**

X ⇒ 36,5
Y ⇒ 46,5
Z ⇒ 14

Prezzo Unitario

**Sedile Soft Close Sat 22 SAT22**

Codice	Riferimenti	Listino A	Listino B	Off.	Box
SAT22	1	72,11 €	80,05 €	1	10
SAT22x5	5	66,23 €	73,51 €	1	10

Elenco di Alcuni Modelli Adattabili

Azienda	Modelli	Azienda	Modelli
Catalano	Canova		
Cesame	Belle Epoque		
Hidra	Memory		

Visiona l'elenco generale a Pag.

180-185

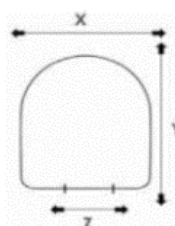
**SAT22**

X ⇒ 37
Y ⇒ 44
Z ⇒ 14

Prezzo Unitario

**Sedile Termoindurente Per Disabile Soft Close SAT23**

Codice	Riferimenti	Listino A	Listino B	Off.	Box
SAT23	1	72,11 €	80,05 €	1	10
SAT23x5	5	66,23 €	73,51 €	1	10

Elenco di Alcuni Modelli Adattabili

Azienda	Modelli	Azienda	Modelli
	Disabile Aperto		

Visiona l'elenco generale a Pag.

180-185

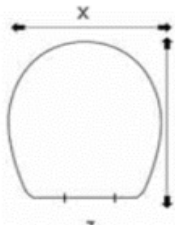
**SAT23**

X ⇒ 37
Y ⇒ 44
Z ⇒ 14

Prezzo Unitario

**Sedile Termoindurente Soft Close SAT 24 SAT24**

Codice	Riferimenti	Listino A	Listino B	Off.	Box
SAT24	1	58,07 €	64,46 €	1	10
SAT24x5	5	53,33 €	59,20 €	1	10

Elenco di Alcuni Modelli Adattabili

Azienda	Modelli	Azienda	Modelli
Opera Sanitari	Area	Althea	D.Style
Pozzi Ginori	Fantasia 2	Azzurra	Tulip One
Rak	Metropolitan	Cielo	Cubica
Esedra	Quadra	Duravit	D-Code
Galassia	Meg 11	Globo	Daily
Grohe	Cube	Hatria	Bianca

Visiona l'elenco generale a Pag.

180-185

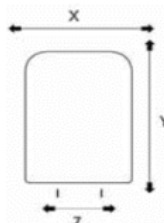
**SAT24**

X ⇒ 35
Y ⇒ 43
Z ⇒ 19

Prezzo Unitario



SAT25

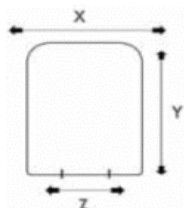

X ⇨ 35
Y ⇨ 43
Z ⇨ 19

Prezzo Unitario

Sedile Termoindurente Soft Close SAT 25 SAT25

Codice	Riferimenti	Listino A	Listino B	Off.	Box
SAT25	1	58,07 €	64,46 €	1	10
SAT25x5	5	53,33 €	59,20 €	1	10

Elenco di Alcuni Modelli Adattabili

Azienda	Modelli	Azienda	Modelli
G.S.I.	Traccia		
Roca	Debba		
Vitra	S20		

Visiona l'elenco generale a Pag.

180-185

SAT26

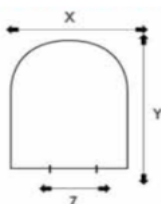

X ⇨ 36
Y ⇨ 45,5
Z ⇨ 17

Prezzo Unitario

Sedile Termoindurente Soft Close SAT 26 SAT26

Codice	Riferimenti	Listino A	Listino B	Off.	Box
SAT26	1	58,07 €	64,46 €	1	10
SAT26x5	5	53,33 €	59,20 €	1	10

Elenco di Alcuni Modelli Adattabili

Azienda	Modelli	Azienda	Modelli
Alice	Unica Slim		
Althea	Soul Slim		

Visiona l'elenco generale a Pag.

180-185

SAT27

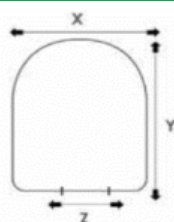

X ⇨ 36,5
Y ⇨ 45,5
Z ⇨ 17

Prezzo Unitario

Sedile Soft Close Sat27

Linea Slim SAT27

Codice	Riferimenti	Listino A	Listino B	Off.	Box
SAT27	1	73,38 €	81,45 €	1	10
SAT27x5	5	67,39 €	74,80 €	1	10

Elenco di Alcuni Modelli Adattabili

Azienda	Modelli	Azienda	Modelli
ALTHEA	MARION	CESABO	ENDURANCE
AXA	CLIVIA	CESAME	SINTESI
AXA	CLIVIA SOSP.	CIELO	CELIA
AZZURRA	ELIOS	DISEGNO CERAMICA	GIULIA
AZZURRA	ELIOS PLUS	DOLOMITE	CLODIA
CATALANO	NEW SFERA	ESEDRA	MIX

Visiona l'elenco generale a Pag.

180-185

SATSU

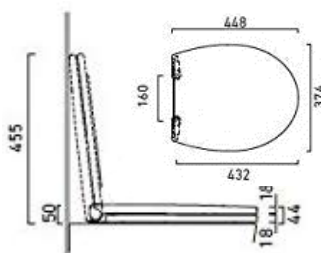
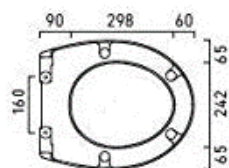

Prezzo Unitario

Sedile Soft Close Satsu Universaleuniversal Slim

Adattabilità serie Fast Azzurra SATSU

Codice	Riferimenti	Listino A	Listino B	Off.	Box
SATSU	1	37,95 €	42,13 €	1	10
SATSUx5	5	34,86 €	38,69 €	1	10

Elenco di Alcuni Modelli Adattabili

Azienda	Modelli	Azienda	Modelli
ALTHEA	HOLA		UNIVERSALE
GLOBO	LEI		
GLOBO	SKY		
AZZURRA	GIOVE		
HATRIA	ERIKA		

Visiona l'elenco generale a Pag.

180-185



SATEMY

Sedile Soft Close Sat PER SANITARUI EMY SATEMY

Codice	Riferimenti	Listino A	Listino B	Off.	Box
SATEMY	1	70,85 €	78,64 €	1	10
SATEMYx5	5	65,07 €	72,22 €	1	10

Elenco di Alcuni Modelli Adattabili

Azienda	Modelli	Azienda	Modelli
	EMY		

Visiona l'elenco generale a Pag. 180-185



Prezzo Unitario



Copriwater Oggi Bianco In PVC Soft Close Sgancio di Rilascio.

SAT1750

Codice	Riferimenti	Listino A	Listino B	Off.	Box
SAT1750	1	34,08 €	34,08 €	1	10
SAT1750x5	5	30,36 €	30,36 €	1	10

Elenco di Alcuni Modelli Adattabili

Azienda	Modelli	Azienda	Modelli
	Civita Oggi Nepi		
	Universal		

Visiona l'elenco generale a Pag. 180-185

1,5 circa

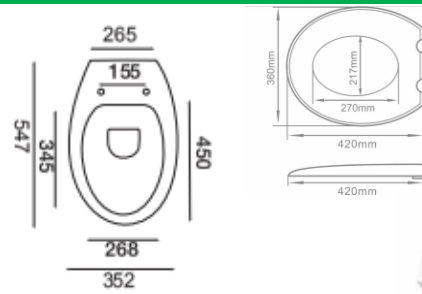

SAT1750



Prezzo Unitario

Copriwater Oggi Bianco Soft Close Sgancio di Rilascio.

Termoindurente SAT1757

Codice	Riferimenti	Listino A	Listino B	Off.	Box
SAT1757	1	45,55 €	50,56 €	1	10
SAT1757x5	5	41,83 €	46,43 €	1	10

Elenco di Alcuni Modelli Adattabili

Azienda	Modelli	Azienda	Modelli
	Universal		

Visiona l'elenco generale a Pag. 180-185

2,4 circa

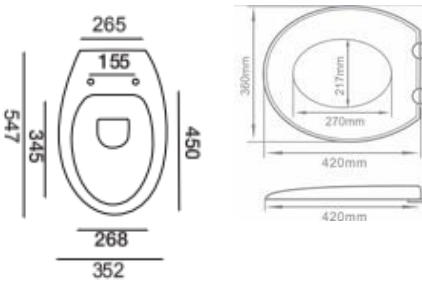

SAT1757



Prezzo Unitario

Copriwater Forma Q Bianco Lucido Slim

Codice	Riferimenti	Listino A	Listino B	Off.	Box
SAT523	1	Arrivo	Arrivo	1	10
SAT523x5	5	Arrivo	Arrivo	1	10

Elenco di Alcuni Modelli Adattabili

Azienda	Modelli	Azienda	Modelli
Azzurra	Build		
Domus Faleri	Foglia Quadra		
Globo	Stone		
Gsg	Brio		
Jka	Deep		

Visiona l'elenco generale a Pag. 180-185

2,4 circa

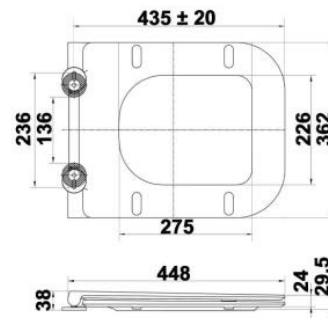

Prezzo Unitario



SAT524

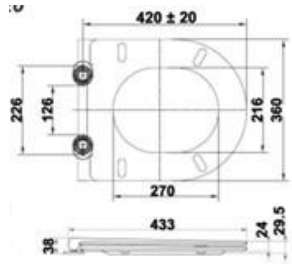

Prezzo Unitario

Copriwater Soft Close Sgancio di Rilascio. Termoindurente

SAT524

Codice	Riferimenti	Listino A	Listino B	Off.	Box
SAT524	1	55,67 €	61,79 €	1	10
SAT524x5	5	51,12 €	56,75 €	1	10

Elenco di Alcuni Modelli Adattabili

Azienda	Modelli	Azienda	Modelli
Alice	Unica	Galassia	Dream
Amerina	Athena/Senso/Sleek	Domus Faleri	Foglia
Azzurra	Comoda/Forma	Flaminia	App/Link
Catalano	Canova Royal/Sfera 63	Globo	Forty 3
	Sferac New Flush Eco-70	Gsg	Flut/Like
	Sfera Confort New Flush	Gsi	Community/KubeX/Pura/Norm

Visiona l'elenco generale a Pag.

180-185

SAT527

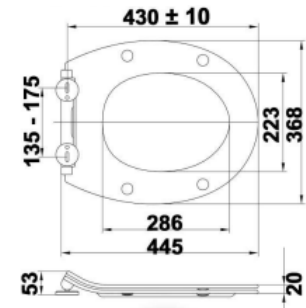

Prezzo Unitario

Copriwater Soft Close Sgancio di Rilascio. Termoindurente

SAT527

Codice	Riferimenti	Listino A	Listino B	Off.	Box
SAT527	1	45,55 €	50,56 €	1	10
SAT527x5	5	41,83 €	46,43 €	1	10

Elenco di Alcuni Modelli Adattabili

Azienda	Modelli	Azienda	Modelli
	Universale		
Althea		HAtria	
Azzurra		Huida	
Catalano			
Cielo			
Gsi			

Visiona l'elenco generale a Pag.

180-185

Kg. 2,4 circa

SEDILI UNIVERSALI
UNIVERSAL SEATS



SEDILI COMUNITÀ E RIALZATI
COMMUNITY AND RAISED SEATS



RICAMBI
SPARE PARTS

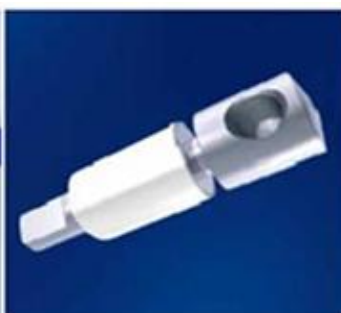

SEDILI COMPATIBILI CON SERIE CERAMICHE
CERAMIC SERIES COMPATIBLE SEATS

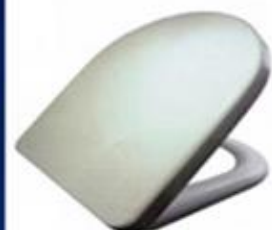

Nozioni Tecniche

TAKE  OFF original

Il sistema permette di estrarre e riposizionare il sedile semplicemente con una mano e quindi facilita la pulizia e l'igiene completa.

SOFT  CLOSE classic

Sistema di chiusura provato con test di lunga durata. Movimento dolce e continuo. Resistente perché integrato nel copriwater. Silenzioso perché senza rischi di rumore causato dalla frizione delle componenti.

DURO  PLAST

La resina termoindurente Urea (Duroplast) è materiale altamente performante con l'aspetto e la sensazione al tatto della ceramica, è il materiale ideale: resiste a prove di rottura estreme ed ha una superficie estremamente rigida e liscia. L'essenza non porosa permette di mantenere il massimo dell'igiene. La qualità di Urea rimane inalterata anche dopo anni di frequente utilizzo.



Kit Cerniere In Acciaio Zinc.
SATCZ

Codice	Riferimenti	Listino A	Listino B	Off.	Box
SATCZ		15,18 €	16,85 €	1	10



Set Paracolpi Sedili Termoid.
SATSP

Codice	Riferimenti	Listino A	Listino B	Off.	Box
SATSP		1,37 €	1,52 €	1	10



Kit Cerniere Acciaio Horizont
SATCH

Codice	Riferimenti	Listino A	Listino B	Off.	Box
SATCH		17,71 €	19,66 €	1	10



Kit Cerniere In Acciaio "Expo"
SATCE

Codice	Riferimenti	Listino A	Listino B	Off.	Box
SATCE		18,98 €	21,06 €	1	10



Kit Cerniere Acciaio Revival
SATCR

Codice	Riferimenti	Listino A	Listino B	Off.	Box
SATCR		15,18 €	16,85 €	1	10



Kit Cerniere In Plastica SATCP

Codice	Riferimenti	Listino A	Listino B	Off.	Box
SATCP		8,86 €	9,83 €	1	10

SAT1

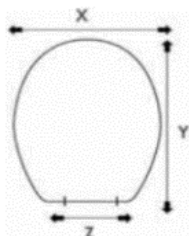

X ⇨ 39
Y ⇨ 45,5
Z ⇨ 15

Sat 1 Copriwater Termoindurente SAT1

Codice	Riferimenti	Listino A	Listino B	Off.	Box
SAT1	1	19,15 €	21,26 €	1	10
SAT1x5	5	18,59 €	20,64 €	1	10

Elenco di Alcuni Modelli Adattabili

Azienda	Modelli	Azienda	Modelli
Incea	Opi/Vesuvio	Cesabo	Elite/Dorica
Simas	Alfa/Beta	Cielo	Ermae/Euro
G.S.I.	Garda/Giada	Faleri	Gaia/Jubilo
Hatria	Amalfi/Cannes	Flaminia	Arena/Nori
Pozzi Ginori	Cardena	Galassia	Ola/Vera

Prezzo Unitario

Visiona l'elenco generale a Pag.

180-185

Semiavvolgente kg. 1,7 circa

SAT2

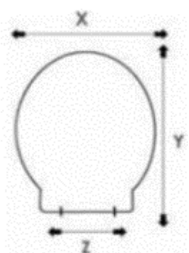

X ⇨ 37,5
Y ⇨ 42,5
Z ⇨ 18

Sat 2 Copriwater Termoidurente SAT2

Codice	Riferimenti	Listino A	Listino B	Off.	Box
SAT2	1	37,11 €	41,19 €	1	10
SAT2x5	5	36,02 €	39,98 €	1	10

Elenco di Alcuni Modelli Adattabili

Azienda	Modelli	Azienda	Modelli
Cesabo	Elite/Dorica	Faleri	Novella
Cielo	Ermae/Euro	Flaminia	Arena/Nori
Cielo	Italia	G.S.I.	Garda/Giada
Duravit	Architect	Hidra	Athena/Record
Eos	Arkea/cimino	Ideal Standard	Elisse/Terso
Faleri	Gaia/Jubilo		

Prezzo Unitario

Visiona l'elenco generale a Pag.

180-185

Avvolgente kg. 2,2 circa

SAT3

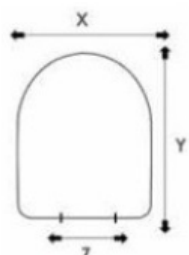

X ⇨ 37
Y ⇨ 45,5
Z ⇨ 18

Sat 3 Copriwater Termoindurente SAT3

Codice	Riferimenti	Listino A	Listino B	Off.	Box
SAT3	1	37,11 €	41,19 €	1	10
SAT3x5	5	36,02 €	39,98 €	1	10

Elenco di Alcuni Modelli Adattabili

Azienda	Modelli	Azienda	Modelli
Azzurra	Elios/Frine	G.S.I.	Chiara/Havant
Astra	Eden/Gemma	Flaminia	Metro MB
Athea	Lisa	Globo	Alia/Flavia
Cesame	Aretusa	Ideal Standard	Fiorile/Linda
Faleri	Adria/Aida	Hatria	Dolce Vita
Galassia	Aster	Simas	Europa

Prezzo Unitario

Visiona l'elenco generale a Pag.

180-185

Avvolgente kg. 2,5 circa

SAT4

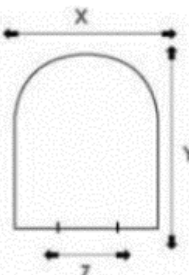

X ⇨ 37
Y ⇨ 45
Z ⇨ 18

Sat 4 Copriwater Termoindurente SAT4

Codice	Riferimenti	Listino A	Listino B	Off.	Box
SAT4	1	37,11 €	41,19 €	1	10
SAT4x5	5	36,02 €	39,98 €	1	10

Elenco di Alcuni Modelli Adattabili

Azienda	Modelli	Azienda	Modelli
Archjade	Appia Sospeso	Galassia	Krio/krio HB
Catalano	Esedra	G.S.I.	Oceano
Delta	Euro	New Castle	Phatos
Dolomite	Corallo	Pozzi Ginori	Atena/Baia
Faleri	F 200	Hatria	Daytime/Onda
Flaminia	Link	Ideal Standard	Esedra

Prezzo Unitario

Visiona l'elenco generale a Pag.

180-185

Avvolgente kg. 2,7 circa



Sat 5 Copriwater Termoindurente SAT5

Codice	Riferimenti	Listino A	Listino B	Off.	Box
SAT5	1	37,11 €	41,19 €	1	10
SAT5x5	5	36,02 €	39,98 €	1	10

Elenco di Alcuni Modelli Adattabili

Azienda	Modelli	Azienda	Modelli
Althea	Hola	Cesabo	Alexandra
	Hola Sospeso	Faleri	Magica
Archiade	Kerafin	Globo	Lei
Astra	Olympia	Gravenia	Jenny
Azzurra	Full 56	G.S.I.	Essenza
	Zeus	Olympia	Merkur

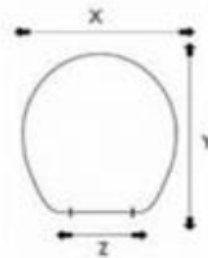

SAT5

X ⇨ 39
Y ⇨ 45,5
Z ⇨ 15

Prezzo Unitario

Visiona l'elenco generale a Pag.

180-185

te kg. 2,2 circa

Sat 6 Copriwater Termoindurente SAT6

Codice	Riferimenti	Listino A	Listino B	Off.	Box
SAT6	1	37,11 €	41,19 €	1	10
SAT6x5	5	36,02 €	39,98 €	1	10

Elenco di Alcuni Modelli Adattabili

Azienda	Modelli	Azienda	Modelli
Axa	Clivia	Eos	Clio
	Clivia Sospeso	Flaminia	Relax
Azzurra	Afrodite	Galassia	Agora'
Catalano	Canova	Kerasan	Godio
Cielo	Ares	Olympia	Rubino
Disegno Ceramica	Giulia	Pozzi Ginori	Idea/Linea

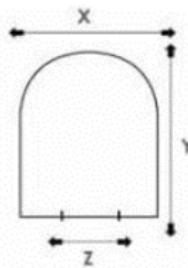

SAT6

X ⇨ 35
Y ⇨ 44,5
Z ⇨ 18

Prezzo Unitario

Visiona l'elenco generale a Pag.

180-185

te kg. 2,4 circa

Sat 7 Copriwater Termoindurente SAT7

Codice	Riferimenti	Listino A	Listino B	Off.	Box
SAT7	1	56,26 €	62,45 €	1	10
SAT7x5	5	54,61 €	60,62 €	1	10

Elenco di Alcuni Modelli Adattabili

Azienda	Modelli	Azienda	Modelli
Ideal Standard	Conca		

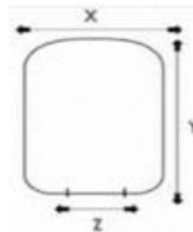

SAT7

X ⇨ 35,5
Y ⇨ 45,5
Z ⇨ 16,5

Prezzo Unitario

Visiona l'elenco generale a Pag.

180-185

te kg. 2,5 circa

Sat 8 Copriwater Termoindurente SAT8

Codice	Riferimenti	Listino A	Listino B	Off.	Box
SAT8	1	58,65 €	65,10 €	1	10
SAT8x5	5	56,93 €	63,19 €	1	10

Elenco di Alcuni Modelli Adattabili

Azienda	Modelli	Azienda	Modelli
Catalano	Luce		
Ideal Standard	Tesi		

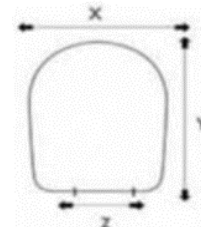

SAT8

X ⇨ 35,5
Y ⇨ 45,5
Z ⇨ 17,5

Prezzo Unitario

Visiona l'elenco generale a Pag.

180-185



Ricerca Per Azienda e Modello			Ricerca Per Azienda e Modello			Ricerca Per Azienda e Modello		
Azienda	Modello	Sat	Azienda	Modello	Sat	Azienda	Modello	Sat
Althea	Centro slow close	11	Cesabo	Elte	1-14-SU	Faleri	Adria - Adria Sospeso	3-13
	Fly slow close	11		Eridurance	6-19		Duelta . F30	9
	Hola	5-14-SU		Exel	1-11		Fish	5-14-SU
	Hola Sospeso	5		Kris	4-10		Foglia	6-19
	Marion	3-16	Cesame	Aretusa Aretusa MB	3-13		Magica	5-14-SU
	Ring	6-19		Aretusina	6-19		H 20 Small Slim	26
	Sky	1		Belle Epoque	22		H 20 Small	19
	Smart	4-10		Fenice	21	Flaminia	Fidia	16
	Marion Slim	27		Mid	2		Link	4-10
	Soul Slim	26		Sintesi - System	6-19		Metro Metro MB	3-16
	D. Style	24	Cielo	Ares Astra	6		Mini Link	17
	Soli	19		Celia	6-19		Pompei	1
Art Ceramica	Ten Slim	27		Easybath	2-12		Relax	6-19
	File Slim	26		Ermes - Euro	1		App Slim	26
	Ten	19		Easy/Evo	2-12		Meno Slim	26
Ala	New Today /Wave	19		Euro	11		Spin	19
Alice	Unica Slim	26		Florence	3-16			
Astra	Gemma	6-19		Lara	1-11	G.S.I	Clizia	5-14-SU
Axa	Axa 2	4-10		Medea	3-16		Essenza	5-11
	Axa One slow close	17		Mithos	2		Havant	3-16
	Clivia Clivia Sospeso	6-19		Smile	4-10		Traccia	25
				Enjoy Slim	26		Xenia	6-19
Azzurra	Afrodite	6-19		Smile Slim	26		City	11
	Diana	6-13		Cubica	24		Pura	4-10
	Elios - Elios Plus	6-19	Delta	Trevi 2			Pura 55 Slim	26
	Frine	6	Disegno	Giulia	6-19		Quid	26
	Ful 48	2-12	Ceramica	Paolina	2		Modo	21
	Full 54	12		Ovo	21			
	Full 56	5-14-SU	Dolomite	Alpina	19	Galassia	Agorà	6-19
	Giove	1		Clodia	3-16		Aster	3-16
	Giunone / Jubileaeum	2		Petra	16		Ethos	2
	Comoda Slim	26		Quadrarco	19		Ola	1-14-SU
	Midas	6-19		Tenax	15		M2 55	6
	Mini Nuvola Quadrato	17		Suite	25		M2 45/55	9-19
	Mini Nuvola Tondo	9		Petra Slim	27		Piuma	19
	Nuvola	6-10		Quadrarco Slim	27		Dream Slim	26
	Pratica	6-19	Dolomite	Dahlia / Novelia	21		Meg 11	24
	New Light	19		Albina MB	19	Globo	Alia	3-16
	Forma	27		Sweet Life	21		Arianna	1-14-SU
	Tulip One	24	Duravit	Happy D	4-10		Bonsai	12
	Nuvola Slim	26		D-Code	24		Flavia	3-16
	Absolute /Frine	19	Eos	Astra	3-16		Grace	6-19
Catalano	C 52 / C 54	4-10	Esedra	Clio	6-19		Lei	5-14-SU
	Neve Sfera	3-16		Mistral	6-19		Misura	3-16
	Canova	22		Punto / Punto Sospeso	3-16		Open Space	4-10
	Luce	14-SU		Esè - Mix	6-19		Pestum	2
	Neve	3		Poing	12		Bowl	6-19
	Sistema C 52	4-10		Bull	6-19		Alia Slim	27
Catalano	Sfera Slim	26		Quadra	24		Misura Slim	27
	Sfera 54 Slim	26		Basic	21		Mode Slim	26
	Zero Slim	26		Fox	19		Open Space Slim	26
	Canova	22	Etruria	Alba	3		Daily	24
	Velis / Sfera 53 / Sfera 54	19					4 All /Open	19



Ricerca Per Azienda e Modello

Ricerca Per Azienda e Modello

Ricerca Per Azienda e Modello

Azienda	Modello	Sat	Azienda	Modello	Sat	Azienda	Modello	Sat	
Gravenia	Derby	1	Incea	Hide	11	Pozzi Ginori	Ydra	3-16	
	Garbo - Garbo MB	3		Joe	15		Fantasia 2	25	
	Giada	6-19		Laura	4-10		Q 3	25	
	Jenny	1-14-SU		Nube	6-19		Ydra Slim	27	
Grohe	Cube	24		Opi	1-14-SU	500 / Raggio / Square	24		
GSG Ceramiche	Like Slim	27		Piuma	6-19	Hide Square / Metrica	24		
G.S.I.	Pura 55 Slim	26		Supra	15		Egg	19	
	Quid	26		Luna	19	Rak	Orient	8	
	Modo	21	Jumbo	Aretona	13		S 50	17	
	Xenia	19		Ego	9		Metropolitan / Summit	24	
Hatria	Cannes	1		Tua	3-16		Compac1	3-13	
	Daytime	4		Tua Slim	27		Moon	4-10	
	Dolce Vita	4	Laufen	Dino	6-19		Moon Slim	26	
	Erika	1-14-SU		Harmony	3		Resort Slim	26	
	Marylin	3-16		Vienna	26		Caroline / S 20	24	
	Fusion	27		Palomba	24		Venice	21	
	Marylin Slim	27	Nero Ceramica	Aliseo	20	Roca	Giralda	3	
	Daytime Slim	26		Classic	3		Polo	18	
	Fusion Slim	26		Genesi	6-19		Polo Sopeso	6-19	
	Fusion tondo	26		Iceberg	11		Tipo	17	
Hatria	Bianca	24		Yesterday	5		Victoria	18	
	Fusion	27		Skil	15		Debba	25	
	Marylin Slim	27		Round	6-19		Set - 2 / The Gap	24	
	Daytime Slim	26		Nero Slim	26	Sanisuda	Alta	3-16	
	Fusion Slim	26		Bianca	24		Aveiro	6-19	
	Fusion Tondo	26	Olympia	Federica	3-16		City	4-10	
	Erika Pro Q	24		Impero	2		Look	24	
	Fusion quadro	24		Merkur	5-14-SU	Scala	Gemma	15	
	Hidra	Pluvia	3-16		Nicole	4-10	Scic	Donna	16
		Roma	1		Rubino	3-16	Senesi	Pienza	6
Smarty		12		Serie 92	6-19		Donatello	15	
Top Line		16		Vela	3	Simas	Arcade	18	
Pegaso		16		Cristal Slim	27		Eline	4-10	
Memory		22	Opera Sanitari	Area	24		Europa	3-16	
				Aida	6-19		Flow	2	
				Onda Endurance	19		Londra	2	
House	Prima	5		Narcisia	4-19		E - Line Slim	26	
Kerasan	Europa	1		Zero	4-10		Eline Slim	26	
	Flo	4		Sally	6-19		Vignomi	19	
	Flo 48	17		Onda	3-16	Vavid	Orientale	3	
	Flo 52	10		Young	6-19		Emilia / Glazia	24	
	Godia	3-16		Oxa	6-19	Veliero	Colombo	3-16	
	Volant	2		Fly	1-14-SU		Colombo 2	6-19	
	Flo Slim	26		Letizia	6-19		Odissea	6-19	
	Acquatech /Nolita	19		Serena	1-14-SU		Tirreno	3-16	
	Ideal Standard	Conca	7		Sally Slim / Venere	27		Valentina	3
		Esedra	4-14-SU		Laguna Slim	26	Vitra	S20	25
Fiorile		3-16		Nemesi Slim	26		Zentrum	17	
Tesi		8		Zero Slim	26		Form Slim	26	
Gemma 2 Slim		27		Aerea / Selfie	24		Matrix Slim	26	
D-Style		24	Pozzi Ginori	Colibri - Colibri 2	15		Senti Slim	26	
Esedra Q.		24		Kim	1		Eolis Karag Slim	26	
Gemma 2		24		Linea	6-19	Vitruvit	Armonia	3-16	
Tonic		24		Monte Bianco	2		Young	6-19	
Selfie 2		24		Novecento	20	Vulcano	Diamonte /Genesi	19	
Italian Style Bath	Bristol	19		Panda	18		Art Ceram	19	
	Piccadilly	19		Quinta	5				
	Broadway	24		Selnova 3	3-19				

Visiona Alcuni Modelli di Copriwater Riferimento Azienda e Modello

Azienda Adattabilità
Modello Copriwater

Azzurra SAT523
Build

Azzurra
Fast SAT14

Azzurra
Cult SAT14

Azienda Adattabilità
Modello Copriwater

Azzurra SAT10 SAT26
Comoda SAT524

Azzurra SAT10 SAT26
Forma SAT524

Azzurra
Prua

Azienda Adattabilità
Modello Copriwater

Althea
Cento SAT11

Alice SAT14
Unica SAT524

Amerina SAT10
Sleek SAT524

Azienda Adattabilità
Modello Copriwater

Cielo
Easy Bath SAT2 SAT12

Amerina SAT19
Senso SAT524

Amerina SAT19
Athena SAT524

Azienda Adattabilità
Modello Copriwater

Catalano
New-Flush 52

Catalano SAT22 SAT538
Canova Royal SAT524

Catalano SAT3 SAT19
Sfera 63 SAT524

Azienda Adattabilità
Modello Copriwater

Catalano SAT10
Sfera Confort SAT524

Catalano SAT10
Sfera New Flush SAT524

Catalano SAT532
New-Light 50 SAT15

<p>AZZURRA Build</p> 	<p>AZZURRA Fast</p> 	<p>AZZURRA Cult</p> 
<p>AZZURRA Comoda</p> 	<p>AZZURRA Forma</p> 	<p>AZZURRA Prua</p> 
<p>ALTHEA Cento</p> 	<p>ALICE Unica</p> 	<p>AMERINA Sleek</p> 
<p>CIELO Easy Bath</p> 	<p>AMERINA Senso</p> 	<p>AMERINA Athena</p> 
<p>CATALANO New-Flush 52</p> 	<p>CATALANO Canova Royal</p> 	<p>CATALANO Sfera 63</p> 
<p>CATALANO Sfera Confort New Flush</p> 	<p>CATALANO Sfera New Flush Eco 70</p> 	<p>CATALANO New-Light 50</p> 
<p>CATALANO New-Light 52</p> 	<p>CATALANO Velis- 50</p> 	<p>CATALANO Canova Royal</p> 

Visiona Alcuni Modelli di Copriwater Riferimento Azienda e Modello

<p>CATALANO New-Flush 52</p> 	<p>CATALANO Sfera 50</p> 	<p>CATALANO Sfera 62</p> 
<p>CATALANO Sfera 70</p> 	<p>CATALANO Sfera 52</p> 	<p>CESAME Sintesi</p> 
<p>CESAME Aretusina</p> 	<p>DOMUS FALERII Foglia Quadra</p> 	<p>DOMUS FALERII Foglia</p> 
<p>DOMUS FALERII Small</p> 	<p>DOLOMITE Gemma 2</p> 	<p>FLAMINIA App</p> 
<p>FLAMINIA Link</p> 	<p>GALASSIA Dream</p> 	<p>GSG Brio</p> 
<p>GSG Flut</p> 	<p>GSG Like</p> 	<p>GSI Community</p> 
<p>GSI Kube X</p> 	<p>GSI Pura</p> 	<p>GSI Norm</p> 

Azienda	Adattabilità
Modello	Copriwater
Catalano	SAT14
New-Light 52	SAT532
Catalano	SAT14
Velis-50	SAT532
Catalano	SAT22
Canova Royal	

Azienda	Adattabilità
Modello	Copriwater
Catalano	
New-Flush 52	SAT532
Catalano	SAT17
Sfera 50	SAT538
Catalano	SAT4 SAT10
Sfera 62	SAT538

Azienda	Adattabilità
Modello	Copriwater
Catalano	
Sfera 70	SAT538
Catalano	
Sfera 52	
Cesame	
Sintesi	SAT6 SAT19

Azienda	Adattabilità
Modello	Copriwater
Cesame	
Aretusina	SAT6 SAT19
Domus-Faleri	
Foglia Quadra	
Domus-Faleri	SAT523 SAT524
Foglia	SAT6 SAT19

Azienda	Adattabilità
Modello	Copriwater
Domus-Faleri	SAT538
Small	SAT19
Dolomite	
Gemma 2	SAT24
Flaminia	SAT26
App	SAT524

Azienda	Adattabilità
Modello	Copriwater
Flaminia	SAT10
Link	SAT4 SAT524
Galassia	SAT26
Dream	SAT524
Gsg	SAT523
Brio	SAT24
Gsg	
Flat	SAT524

Visiona Alcuni Modelli di Copriwater Riferimento Azienda e Modello

Azienda Adattabilità
Modello Copriwater

- Gsi**
- Classic** SAT532
- Globo** SAT523
- Stone**
- Globo**
- Forty3** SAT17 SAT524

Azienda Adattabilità
Modello Copriwater

- Hatria**
- Beta** SAT6 SAT19
- Hatria** SAT14
- Erika Pro** SAT532
- Hatria** SAT532
- Nido Sospeso** SAT15

Azienda Adattabilità
Modello Copriwater

- Hatria**
- Daytime Evo** SAT4 SAT10
- Hatria**
- Bianca** SAT24
- Hatria**
- Fusion** SAT26

Azienda Adattabilità
Modello Copriwater

- Jika**
- Zeta** SAT14
- Jika** SAT14
- Profil** SAT538
- Jika** SAT523
- Deep** SAT14
- Jika**
- Lyra Plus** SAT524

Azienda Adattabilità
Modello Copriwater

- Ideal Standard**
- Tesi** SAT8
- Ideal Standard**
- Tonic II** SAT24
- Jacuzzi** SAT3 SAT19
- Glow** SAT524

Azienda Adattabilità
Modello Copriwater

- Ideal Standard**
- Conca** SAT7
- Ideal Standard** SATSU
- Esedra** SAT4 Sat14
- Pozzi Ginori** SAT538
- Fast** SAT524





Visiona Alcuni Modelli di Copriwater Riferimento Azienda e Modello

POZZI GINORI Selvova 	RAK Protek 	RAK Compact 	
RAK Tonique 	RAK Feeling 	RAK Moon 	
RAK Origin 	RAK Tonique 	RAK Valet 	
RAK Valet 	ROCA The Gap 	ROCA Neo-Victoria 	SANINDUSA Compact Advance 
SANINDUSA Urb. y 60 	SANINDUSA Urb. y Plus 	SANINDUSA Urb. y Compatto 	SANINDUSA Urb. y 48 
SANINDUSA Suspenza Advance 	SANINDUSA Simples Advance 	SANINDUSA Cetus 48 	SANINDUSA Sanibold 
SANINDUSA Easy 	SANINDUSA Look 	VITRA Sento 	VITRA Normus 

Azienda Adattabilità
Modello Copriwater

Pozzi Ginori
Fantasia 2 SAT25
Pozzi Ginori
Colibri 2 SAT18
Pozzi Ginori
Selvova SAT3 SAT19

Azienda Adattabilità
Modello Copriwater

Rak
Protek SAT4 SAT10
Rak SAT3 SAT19
Compact SAT524
Rak
Tonique SAT3 SAT19

Rak
Feeling SAT524

Azienda Adattabilità
Modello Copriwater

Rak SAT4 SAT10
Valet SAT24

Roca
The Gap SAT24

Roca
Neo-Victoria SAT18

Rak
Moon SAT524

Azienda Adattabilità
Modello Copriwater

Sanindusa SAT24

Compact Advance
Suspenza Advance
Suspenza Advance
Simples Advance
Simples Advance
Sanindusa SAT524

Urb. y Compatto
Urb. y Plus

Urb. y 48/52/60
Sanindusa

Cetus 48 SAT532

Sanindusa SAT524 SAT538
Sanibold SAT24

Sanindusa
Easy SAT15

Azienda Adattabilità
Modello Copriwater

Sanindusa
Look SAT24

Vitra SAT26
Sento SAT538

Vitra
Normus SAT1 SAT14

Vitra Form Slim
Matrix/Sento SAT26



Rialzo Per Seduta Wc
Bianco 101R72004

Codice	Riferimenti	Listino A	Listino B	Off.	Box
101R72004	1	34,81 €	38,64 €	1	10
101R72004x5	5	32,76 €	36,36 €	1	10



Sedile Wc Bianco
Aretusa Fit 101F59004



Codice	Riferimenti	Listino A	Listino B	Off.	Box
101F59004	1	32,13 €	35,66 €	1	10
101F59004x5	5	30,24 €	33,57 €	1	10



SEDILE WC FIT-SERIES
TESI 101E72004



Codice	Riferimenti	Listino A	Listino B	Off.	Box
101E72004	1	32,13 €	35,66 €	1	10
101E72004x5	5	30,24 €	33,57 €	1	10



Sedile Pesante
Universale Bianco
Economico SPUBO

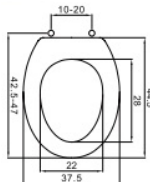

Codice	Riferimenti	Listino A	Listino B	Off.	Box
SPUBO	1	25,97 €	28,83 €	1	10
SPUBOx5	5	24,44 €	27,13 €	1	10

Codice	Riferimenti	Listino A	Listino B	Off.	Box
	1	Arrivo	Arrivo	1	10
x5	5	Arrivo	Arrivo	1	10

Codice	Riferimenti	Listino A	Listino B	Off.	Box
		Arrivo	Arrivo	1	10
x		Arrivo	Arrivo	1	10



Sedile Pesante
Universale Bianco
Economico



Codice	Riferimenti	Listino A	Listino B	Off.	Box
101E77004	1	32,13 €	35,66 €	1	10
101E77004x5	5	30,24 €	33,57 €	1	10



Sedile Wc Fit-Series
Sintesi 2.0 101F98004



kg. 3,2 circa

Codice	Riferimenti	Listino A	Listino B	Off.	Box
101F98004	1	32,13 €	35,66 €	1	10
101F98004x5	5	30,24 €	33,57 €	1	10



SEDILE WC FIT-SERIES
CONCA 101E71004

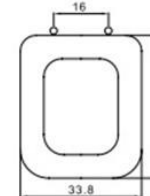

kg. 2,6 circa

Codice	Riferimenti	Listino A	Listino B	Off.	Box
101E71004	1	32,13 €	35,66 €	1	10
101E71004x5	5	30,24 €	33,57 €	1	10

Codice	Riferimenti	Listino A	Listino B	Off.	Box
	1	Arrivo	Arrivo	1	10
x5	5	Arrivo	Arrivo	1	10

Codice	Riferimenti	Listino A	Listino B	Off.	Box
		Arrivo	Arrivo	1	10
x		Arrivo	Arrivo	1	10

Codice	Riferimenti	Listino A	Listino B	Off.	Box
		Arrivo	Arrivo	1	10
x		Arrivo	Arrivo	1	10



Kit Cerniere Pesante cromato.
Completo:
1) Vite serraggio parte superiore 2)
Kit Accessori montaggio
3) Chiave serraggio cavallotti KSSU



Kit Cerniere Pesante cromato.
Completo:
1) Vite serraggio parte superiore:
2) Kit Accessori montaggio
3) Viti montaggio sedile KSSUC

Codice	Riferimenti	Listino A	Listino B	Off.	Box
KSSU		9,24 €	10,25 €	1	10
KSSU10	10	8,69 €	9,65 €	1	10

Codice	Riferimenti	Listino A	Listino B	Off.	Box
KSSUC		7,36 €	8,17 €	1	10
KSSUC10	10	6,93 €	7,69 €	1	10



Supporto Sedile Pesante
Universale Cromato SSP



Supporto Sedile Sovrapposta
SSS

Codice	Riferimenti	Listino A	Listino B	Off.	Box
SSP		5,97 €	6,63 €	1	10
SSP10	10	5,62 €	6,24 €	1	10

Codice	Riferimenti	Listino A	Listino B	Off.	Box
SSS		12,05 €	13,37 €	1	10
SSS10	10	11,34 €	12,59 €	1	10



Supporto Sedile Pesante Un.
Barra SSPU



Supporto Sedile Espansione
SSE

Codice	Riferimenti	Listino A	Listino B	Off.	Box
SSPU		9,64 €	10,70 €	1	10
SSPU5	5	9,07 €	10,07 €	1	10

Codice	Riferimenti	Listino A	Listino B	Off.	Box
SSE		14,73 €	16,35 €	1	10
SSE10	10	13,86 €	15,38 €	1	10



Coppia Cerniere Copriwater
Universale Alette 61 Mm 68
Mm Import DGO-156



Coppia Cerniere Copriwater
Universale Alette 54 Mm 57
Mm Import DGO-157

Codice	Riferimenti	Listino A	Listino B	Off.	Box
DGO-156		6,71 €	7,45 €	1	10

Codice	Riferimenti	Listino A	Listino B	Off.	Box
DGO-157		6,71 €	7,45 €	1	10



Supporto Sedile Pesante
Universale Cromato Satinato
Import 5200689



Kit Cerniera ricambio in
Acciaio Inox 52880

Codice	Riferimenti	Listino A	Listino B	Off.	Box
5200689		6,88 €	7,64 €	1	10

Codice	Riferimenti	Listino A	Listino B	Off.	Box
52880		8,03 €	8,92 €	1	10
5288010	10	7,56 €	8,39 €	1	10



Supporto Moplen Pvc SSM



Set Paracolpi Sedili Termoind.
SATSP

Codice	Riferimenti	Listino A	Listino B	Off.	Box
SSM		0,59 €	0,65 €	1	10

Codice	Riferimenti	Listino A	Listino B	Off.	Box
SATSP		1,37 €	1,52 €	1	10



Sifone Diba BAASP



Codice	Riferimenti	Listino A	Listino B	Off.	Box
BAASP		51,86 €	57,57 €	1	10



anna Curva 45° 30X240 305C30x2

Codice	Riferimenti	Listino A	Listino B	Off.	Box
305C30x24	30X240	4,79 €	5,31 €	1	10
305C30x28	30X280	5,44 €	6,04 €	1	10
305C30x32	30X280	6,20 €	6,88 €	1	10



Batteria Aria Con Kit BAAC00

Colori Disponibili



CROMO BRONZO RAME



Codice	Riferimenti	Listino A	Listino B	Off.	Box
BAAC00	Cromo	107,08 €	118,86 €	1	10
BAAC47	Bronzo	185,25 €	205,62 €	1	10
BAAC65	Rame	188,32 €	209,03 €	1	10



Pulsante Colore Cromo Con Tubo Rame 300100



Codice	Riferimenti	Listino A	Listino B	Off.	Box
300100	Cromo	20,28 €	22,51 €	1	10
300147	Bronzo	20,28 €	22,51 €	1	10
300165	Rame	20,28 €	22,51 €	1	10

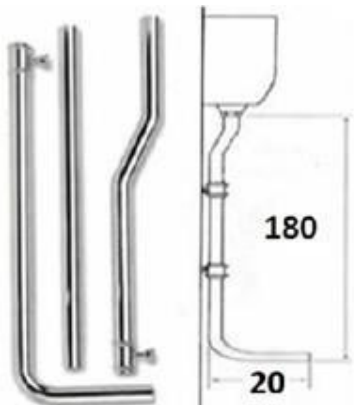

Tubo Esterno Cromo Diba

180

20

Colori Disponibili



CROMO BRONZO RAME



Codice	Riferimenti	Listino A	Listino B	Off.	Box
TED00	Cromo	204,98 €	227,53 €	1	10
TED47	Bronzo	219,62 €	243,78 €	1	10
TED65	Rame	223,82 €	248,44 €	1	10



Rosone Catis Dn. 80 ROC00

Codice	Riferimenti	Listino A	Listino B	Off.	Box
ROC00	Cromo	1,02 €	1,13 €	1	10
ROC47	Bronzo	0,92 €	1,02 €	1	10
ROC65	Rame	0,92 €	1,02 €	1	10



Canna 45°C/Rosone Cm.28 CROMO CCR3000

Codice	Riferimenti	Listino A	Listino B	Off.	Box
CCR3000	Cromo	4,91 €	5,45 €	1	10
CCR3047	Bronzo	20,48 €	22,73 €	1	10
CCR3065	Rame	19,58 €	21,74 €	1	10



Batt.Univ.Comando Pneu. C/Guazz 2410NT0000

Codice	Riferimenti	Listino A	Listino B	Off.	Box
2410NT0000		16,39 €	18,20 €	1	10



Wc Valvola Pulsar Dual + Pulsante CPULSAR2

Codice	Riferimenti	Listino A	Listino B	Off.	Box
CPULSAR2		84,21 €	93,47 €	1	10



Cassette scarico per Wc



CASSETTE PUCCI®
stile e tecnologia italiani



CASSETTE AD INCASSO **PUCCI®**

Sara Pneu

Sara Matic

Tronic

La storia della cassetta



50121040
RAME 10l



50321040
RAME 10r
doppio pulsante





Cassette Zaino Beta Plus CZPB

Scheda
Tecnica



Codice	Riferimenti	Listino A	Listino B	Off.	Pz
CZPB		34,21 €	37,97 €	1	5
CZPBx5	Offertax5	32,41 €	35,97 €	5	5
CZPBx10	Offertax10	30,79 €	34,17 €	10	5
CZPBx15	Offertax15	27,15 €	30,14 €	15	5



Cassette A Zaino Delta Elegant Silenziata Con Polisterolo Bianca CZDB

Scheda
Tecnica



Codice	Riferimenti	Listino A	Listino B	Off.	Pz
CZDB		34,90 €	38,74 €	1	5
CZDBx5	Offertax5	33,07 €	36,70 €	5	5
CZDBx10	Offertax10	31,41 €	34,87 €	10	5
CZDBx15	Offertax15	27,71 €	30,75 €	15	5



Cassette A Zaino Delta 2 Pulsanti Silenziata Bianca CZ2DB

Scheda
Tecnica



Codice	Riferimenti	Listino A	Listino B	Off.	Pz
CZ2DB		49,01 €	54,40 €	1	5
CZ2DBx5	Offertax5	46,43 €	51,53 €	5	5
CZ2DBx10	Offertax10	44,11 €	48,96 €	10	5
CZ2DBx15	Offertax15	38,90 €	43,18 €	15	5



Cassette Alta Completa Cat. CAC

Scheda
Tecnica



Codice	Riferimenti	Listino A	Listino B	Off.	Pz
CAC		30,46 €	33,81 €	1	5
CACx5	Offertax5	28,86 €	32,03 €	5	5
CACx10	Offertax10	27,42 €	30,43 €	10	5
CACx15	Offertax15	24,18 €	26,84 €	15	5



Cassette A Zaino Angolo Bianca CZAB

Scheda
Tecnica

Codice	Riferimenti	Listino A	Listino B	Off.	Pz
CZAB		61,54 €	68,31 €	1	5



Cassette Plus Doppio Scar. B CZP2B

Scheda
Tecnica



Codice	Riferimenti	Listino A	Listino B	Off.	Pz
CZP2B		48,03 €	53,31 €	1	5
CZP2Bx5	Offertax5	45,50 €	50,51 €	5	5
CZP2Bx10	Offertax10	43,23 €	47,98 €	10	5
CZP2Bx15	Offertax15	38,12 €	42,32 €	15	5



Cassette A Zaino Beta S/Rub CZBB

Scheda
Tecnica



Codice	Riferimenti	Listino A	Listino B	Off.	Pz
CZBB		34,52 €	38,32 €	1	5
CZBBx5	Offertax5	32,70 €	36,30 €	5	5
CZBBx10	Offertax10	31,07 €	34,49 €	10	5
CZBBx15	Offertax15	27,40 €	30,42 €	15	5



Cassette Cr Sfera 1Riv.S/Rub 1000S1

Scheda
Tecnica



Codice	Riferimenti	Listino A	Listino B	Off.	Pz
1000S1		47,47 €	52,69 €	1	5
1000S1x5	Offertax5	44,97 €	49,92 €	5	5
1000S1x10	Offertax10	42,72 €	47,42 €	10	5
1000S1x15	Offertax15	37,68 €	41,83 €	15	5



Cassette Wc A Zaino Con Tubo Water Saving Concept 1 pulsanter 1000C1

Scheda
Tecnica



Codice	Riferimenti	Listino A	Listino B	Off.	Pz
1000C1		52,36 €	58,12 €	1	5
1000C1x5	Offertax5	49,60 €	55,06 €	5	5
1000C1x10	Offertax10	47,12 €	52,30 €	10	5
1000C1x15	Offertax15	41,56 €	46,13 €	15	5



Cassette Incasso Fusion Per Muratura E Vaso A Pavimento 1060F

Scheda
Tecnica

Codice	Riferimenti	Listino A	Listino B	Off.	Pz
1060F	1	98,36 €	109,18 €	1	5
1060Fx5	1	92,46 €	102,63 €	5	5



Cassetta Fusion Per Vaso
Sospeso - Universale

Scheda
Tecnica

Codice	Riferimenti	Listino A	Listino B	Off.	Pz
1060FA	1	237,82 €	263,98 €	1	5
1060FAx5	1	201,09 €	223,21 €	5	5



Placca a doppio scarico bianca,
modello ultra-sottile
Adatta all'installazione su
cassetta incasso Fusion



Codice	Riferimenti	Listino A	Listino B	Off.	Pz
1061FB2	1	23,49 €	26,08 €	1	5
1061FB2x5	1	19,86 €	22,05 €	5	5

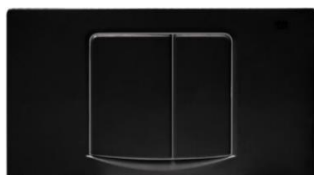

PLACCA NERA SMILE
Placca ultra-sottile a due tasti
per lo scarico ad incasso, colore
nera opaca

Scheda
Tecnica



Codice	Riferimenti	Listino A	Listino B	Off.	Pz
1061FN2	1	54,04 €	59,99 €	1	5
1061FN2x5	1	45,70 €	50,72 €	5	5

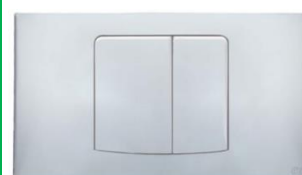

Placca a doppio scarico cromata,
modello ultra-sottile
Adatta all'installazione su
cassetta incasso Fusion

Scheda
Tecnica



Codice	Riferimenti	Listino A	Listino B	Off.	Pz
1061FC2	1	54,16 €	60,12 €	1	5
1061FC2 x5	1	45,80 €	50,84 €	5	5



Meccanismo a scarico singolo con pull a
perlina
Adatto all'installazione su cassette alte in
ceramica
Troppopieno regolabile in altezza
Galleggiante a entrata laterale 3/8"
Vitone in ottone cromato

Scheda
Tecnica

Codice	Riferimenti	Listino A	Listino B	Off.	Pz
1406	1	55,36 €	61,45 €	1	5
1406x5	1	46,81 €	51,96 €	5	5



Meccanismo pneumatico a scarico
singolo, Adatto alla sostituzione di
batterie pneumatiche pre-esistenti su
cassette alte in ceramica
Completo di tubetto 70 cm per
connessione a vecchio tubo in rame
Troppopieno regolabile in altezza
Vitone in ottone cromato

Scheda
Tecnica

Codice	Riferimenti	Listino A	Listino B	Off.	Pz
1407SG	1	43,00 €	47,73 €	1	5
1407SGx5	1	36,36 €	40,36 €	5	5



Porta rotolo cromato, installabile sul
fusto delle cassette wc
Sporgenza 14 cm
Utilizzabile anche per asciugamani e
salviette

Scheda
Tecnica

Codice	Riferimenti	Listino A	Listino B	Off.	Pz
11825N/01	1	4,76 €	5,28 €	1	5
11825N/01x5	1	4,02 €	4,47 €	5	5

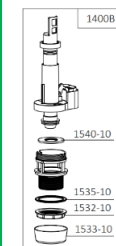

Meccanismo per cassette CR
universale a Zaino e cassetta Alta

Scheda
Tecnica

Codice	Riferimenti	Listino A	Listino B	Off.	Pz
1400B	1	13,82 €	15,34 €	1	5
1400Bx5	1	11,68 €	12,97 €	5	5



Gruppo Sollevamento Pneu GSC

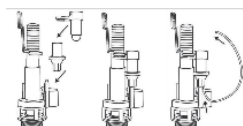

Codice	Riferimenti	Listino A	Listino B	Off.	Pz
GSC	1	28,51 €	31,64 €	1	5
GSCx5	1	27,26 €	30,26 €	5	5



Leva Cassetta Alta Alfa 1531

Codice	Riferimenti	Listino A	Listino B	Off.	Pz
LCAA	1	2,63 €	2,92 €	1	5
LCAAx5	1	2,34 €	2,60 €	5	5



Galleggiante Nanotek, codolo 3/8" ottone per cassette in plastica, completo di adattatori per cassetta incasso Geberit mod. Sigma e cassetta Pucci mod. Sara

Scheda Tecnica

Codice	Riferimenti	Listino A	Listino B	Off.	Pz
1513IT		13,21 €	14,67 €	1	5
1513ITx5	Offertax5	12,49 €	13,87 €	5	5
1513ITx10	Offertax10	11,77 €	13,07 €	10	5
1513ITx15	Offertax15	10,81 €	12,00 €	15	5



Galleggiante Blu Rambo 3/8" GCZBR

Scheda Tecnica



Codice	Riferimenti	Listino A	Listino B	Off.	Pz
GCZBR		7,85 €	8,72 €	1	5
GCZBRx5	Offertax5	7,42 €	8,24 €	5	5
GCZBRx10	Offertax10	7,00 €	7,77 €	10	5
GCZBRx15	Offertax15	6,43 €	7,13 €	15	5



Pull Bianca C/Catenella Cm. 70 PEGB70



Codice	Riferimenti	Listino A	Listino B	Off.	Pz
PEGB70		1,40 €	1,55 €	1	5



Regolatore di Flusso per scarico cassette wc regolazione semplicissima

Codice	Riferimenti	Listino A	Listino B	Off.	Pz
GTR01		0,85 €	0,95 €	1	5



Pulsante Sollevamento Pneu Cr PI

Scheda Tecnica



Codice	Riferimenti	Listino A	Listino B	Off.	Pz
PI		24,90 €	27,64 €	1	5



Pedale Sollevamento Pneu Cr PIC

Scheda Tecnica



Codice	Riferimenti	Listino A	Listino B	Off.	Pz
PIC		50,34 €	55,88 €	1	5



Pulsante Sollevamento Pneu Cr PE

Scheda Tecnica



Codice	Riferimenti	Listino A	Listino B	Off.	Pz
PE		38,95 €	43,23 €	1	5



Pedale Sollevamento Pneu Cr PEC

Scheda Tecnica



Codice	Riferimenti	Listino A	Listino B	Off.	Pz
PEC		40,28 €	44,71 €	1	5



Pedale Sollevamento Pneu Cr PPI

Scheda Tecnica



Codice	Riferimenti	Listino A	Listino B	Off.	Pz
PPI		58,49 €	64,93 €	1	5



Pedale Sollevamento Pneu Cr PPE

Scheda Tecnica



Codice	Riferimenti	Listino A	Listino B	Off.	Pz
PPE		72,69 €	80,68 €	1	5



Gruppo Pulsante Pneu Batt. Monob. 1530B

Codice	Riferimenti	Listino A	Listino B	Off.	Pz
1530B		11,49 €	12,75 €	1	5

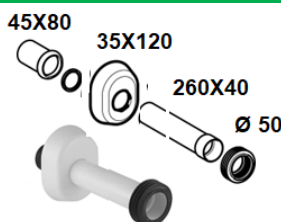

kit per connessione cassetta WC da incasso - Canotto bianco UNIVERSALE tipo Geberit.

Codice	Riferimenti	Listino A	Listino B	Off.	Pz
S97		4,38 €	4,86 €	1	5



Guarnizione Meccanismo Cassetta Cr
1540 GMCZ



Codice	Riferimenti	Listino A	Listino B	Off.	Pz
GMCZ	1	1,09 €	1,21 €	1	5
GMCZx20	1	0,98 €	1,09 €	20	20



TUBO A ZAINO
Ø50x32
Tubi di scarico



Tubo di scarico Ø50 x Ø32, dimensioni
600x220 mm
Adatto all'installazione su cassette wc a
zaino

Codice	Riferimenti	Listino A	Listino B	Off.	Pz
TCZ60	1	6,66 €	7,39 €	1	5
TCZ60x5	1	6,28 €	6,97 €	5	10



Tubo di scarico sagomato Ø50 x Ø32,
dimensioni 800x260 mm
Adatto all'installazione su cassette wc a
zaino

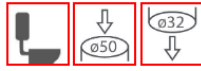

Codice	Riferimenti	Listino A	Listino B	Off.	Pz
TCZS80	1	6,83 €	7,58 €	1	5



Tubo di scarico Ø50 x Ø32, dimensioni
1000x220 mm
Adatto all'installazione su cassette wc a
zaino



Codice	Riferimenti	Listino A	Listino B	Off.	Pz
TCZ100	1	9,91 €	10,99 €	1	5



Tubo Cassetta 2 Pei Usc. 45 TCCA45

Art. 1505

Scheda
Tecnica



Codice	Riferimenti	Listino A	Listino B	Off.	Pz
TCCA45	1	6,73 €	7,47 €	1	5

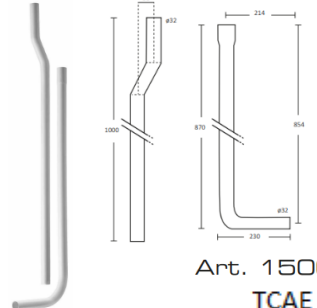

Tubo Cassetta Alta Esterno TCAE

Art. 1500A
TCAE

Scheda
Tecnica



Codice	Riferimenti	Listino A	Listino B	Off.	Pz
TCAE	1	10,40 €	11,55 €	1	5



PILOZZO 50
Pilozzo in polipropilene lucido
Dimensioni: 50 x 34 x h 21 cm

Scheda
Tecnica



Codice	Riferimenti	Listino A	Listino B	Off.	Pz
2051	1	37,70 €	41,85 €	1	5

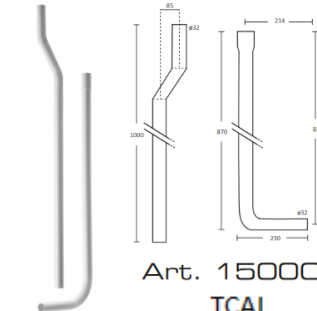

Tubo Cassetta Alta Incasso TCAI

Art. 1500C
TCAI

Scheda
Tecnica



Codice	Riferimenti	Listino A	Listino B	Off.	Pz
TCAI	1	5,40 €	6,00 €	1	5



Pilozzo in polipropilene lucido
Dimensioni: 55 x 34 x h 21 cm
Totalmente lavabile
Imballaggio singolo, salvaspazio,
impilabile

Scheda
Tecnica



Codice	Riferimenti	Listino A	Listino B	Off.	Pz
2051A	1	40,99 €	45,50 €	1	5



PILOZZO 60
Pilozzo in polipropilene lucido
Dimensioni: 60 x 34 x h 21 cm

Scheda
Tecnica



Codice	Riferimenti	Listino A	Listino B	Off.	Pz
2051B	1	43,90 €	48,73 €	1	5

PUCCI® eco® 9ℓ - 4ℓ / 6ℓ - 3ℓ SFIORO®

PER PARETI IN MURATURA - PER WC A PAVIMENTO

CE EMC 2004/108/CE

1415490201

eco® sfiro® 9ℓ - 4ℓ / 6ℓ - 3ℓ
anticondensa



regolazione tubo di risciacquamento
dopo l'installazione 4 cm(+2 -2 cm)

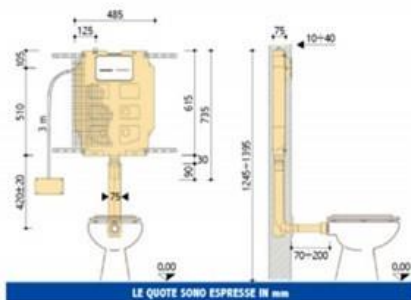

DATI TECNICI

pressione dinamica 0,1-10 bar

temperatura massima dell'acqua 25°C

impostazione predefinita quantità di
risciacquo 9-4ℓ

campo di regolazione risciacquo lungo 9-6ℓ

campo di regolazione risciacquo breve 4-3ℓ

CAMPI D'APPLICAZIONE

- > Per pareti in muratura
- > Per wc a pavimento
- > Risciacquo a due quantità 9-4ℓ / 6-3ℓ

CARATTERISTICHE E DOTAZIONE

- > Cassetta in polietilene spessore 7,5 mm
- > Isolata contro la condensa
- > Rete portaintonaco premontata
- > Servo comando frontale con risciacquo a due quantità
- > Allacciamento idrico dall'alto disassato a sx
- > Rubinetto di arresto 1/2" con supporto
- > 4 staffe sostegno con viti per fissaggio cassetta
- > Tubo di risciacquamento 35 x 11 cm regolabile in altezza (+2-2 cm)
- > Protezione in polistirolo espanso, coppelle e tappo per la regolazione del tubo di risciacquamento
- > Rosone eccentrico e canotto 22 cm
- > Morsetto combinato Ø 48-58 mm con coprimorsetto
- > Manicotto aumento da Ø 40 a Ø 45 mm con OR 143 e morsetto Ø 55-44 mm
- > Confezione lubrificante per guarnizioni
- > Protezione in polistirolo espanso per sportello e particolari interni
- > Alimentatore 220 VAC-12 VDC con cavo da 3 m e connettore
- > Scatola incasso e guaina 3 m

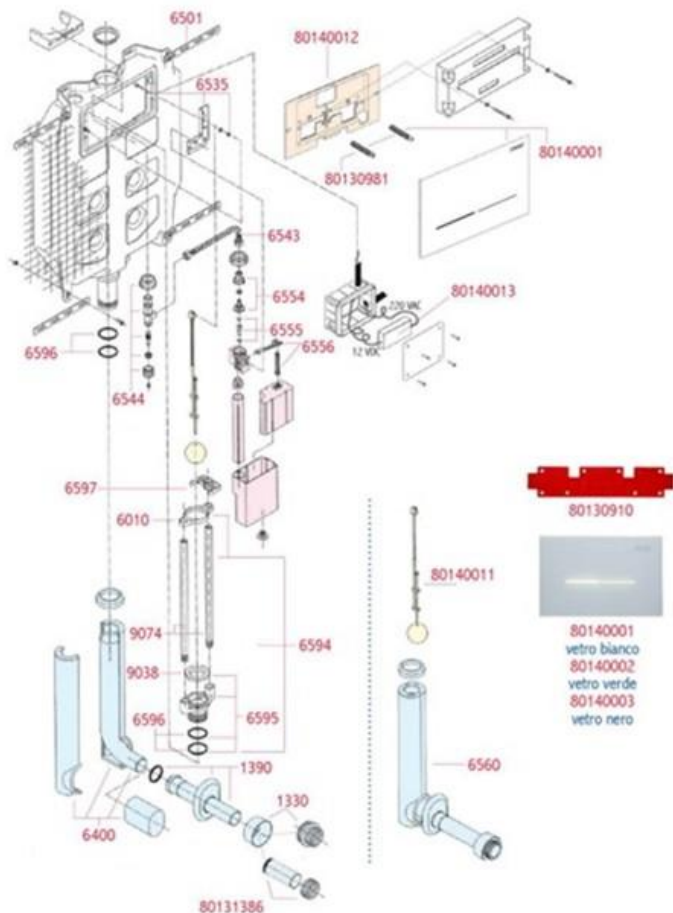

HAI INSTALLATO eco® O SARA DAL 2011
CON PLACCHE 280 x 180

PLACCHE eco®	PLACCHE SARA	PLACCHE eco®	PLACCHE SARA
80000510	80000610	80130550	80130660
80000520	80000620	80130560	80130670
80000530	80000630	80130570	
80000540			

PUOI TRASFORMARLE CON IL KIT
PUCCI eco® SFIORO®

80140091	80140092	80140093
placca vetro bianca	placca vetro verde	placca vetro nera

sportello con servomotore,
batteria di scarico Pucci
Sfiro, * alimentatore,
guaina e scatola da incasso



* L'alimentatore richiede collegamento alla rete 220 V

Eco® Sfiore Pareti in Muratura

Codice	Conf.	Riferimenti	Listino A
P-1330	1	Morsetto Comb.48-58 Bianco P-1330	€ 6,48
P-1390	1	Gruppo Rosone Ecc. Or 143 Can.22 Cm. Bianco Conf.1 P-1390	€ 4,27
P-6010	5	Telaio Guida Sfera Pz. 1 P-6010	€ 1,20
P-6111	1	Corredo Aliment. Eco -Sara P-6111	€ 32,98
P-6535	2	Conf. Staffa Sost. Vaschetta Pz. 1 P-6535	€ 4,97
P-6543	1	Pucci Flessibile F.F. Con Guarnizioni Cod. 80006543 P-6543	€ 11,94
P-6501	1	Serie Di 4 Staffe Con Bulloni Fissaggio Cassetta Muro Conf.1 P-6501	€ 3,57
P-6400	1	Tubo Cacciata 35X11 D.50-40 Con Rivestimento E Tappo P-6400	€ 11,80
Arrivo			
P-6554		Raccordo Valvola Con Sede Interna P-6554	€ 9,57
P-6501	1	Serie Di 4 Staffe Con Bulloni Fissaggio Cassetta Muro Conf.1 P-6501	€ 3,57
P-6544	1	Rubinetto Ottone Da 1/2"Conf.1 P-6544	€ 18,32
P-6550	1	Gruppo Valvola Completo Conf.1 P-6550	€ 28,07
P-6555	10	Pistoncino Con Guarnizione 10X5 Mm Pz. 1 P-6555	€ 1,44
P-6556	1+1	Leve Per Valvola Conf.5 P-6556	€ 4,36
P-6560	1	Tubo Risc.35Cm.Conf.1 P-6560	€ 19,02
P-6595	1	Estraibile Con 2Or 147 E Guar. Sede Econf.1 P-6595	€ 9,84
P-6596	1	OR 147 per sede estraibile e codulo Conf. Pz. 8 Prezzo Pz. 1 P-6596	€ 4,87
P-9038	10	Guarnizione Sede Sfera Conf. 10 pz Prezzo singolo Pz. 1 P-9038	€ 1,82
P-9074	6	Tubo Silenziatore Per Tutti I Modelli P-9074	€ 15,35
P-0910	1	Dima Per Montaggio Vitoni P-0910	€ 4,16
P-0930	1	Serie Viti Registro E Viti Fissaggio Placca Prolungate 7 Cm P-0930	€ 17,70
P-0981	4	Viti Fissaggio Placca Pz 1 P-0981	€ 13,25
P-1386	1+1	Sacchetto A Corredo Manicotto D.40-50Mm D. 45Mm P-1386	€ 11,52
P-6110	1	Sacchetto Corredo Wc Eco Sara P-6110	€ 23,21
80140001	1	Placca Sfiore Bianca 80140001	€ 336,26
80140002	1	Placca Sfiore Verde 80140002	€ 353,08
80140003	1	Placca Sfiore Nera 80140003	€ 353,08
80140011	1	Gruppo Completo 80140011	€ 19,82
80140012	1	Sportello Servomotore 80140012	€ 191,99
80140013	1	Alimentatore 220 Vac - 12	€ 85,58
KIT PUCCI ECO SFIORE: PLACCA+SPORTELLO SERVOMOTORE BATTERIA DI SCARICO ALIMENTATORE SCATOLA DA INCASSO			
80140091	1	Placca Sfiore Bianca 80140091	€ 561,12
80140092	1	Placca Sfiore Verde 80140092	€ 561,12
80140093	1	Placca Sfiore Nera 80140093	€ 561,12

Eco® Sfiore Pareti in Muratura

Placche in Vetro

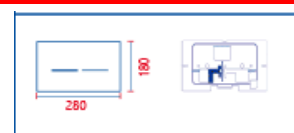
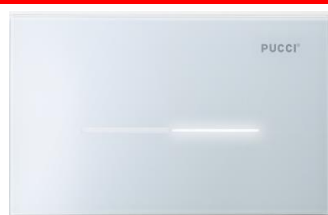

Vetro Bianco
80140001



Vetro Verde
80140002

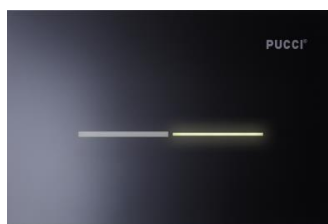

Vetro Nera
80140003

Rete Elettrica

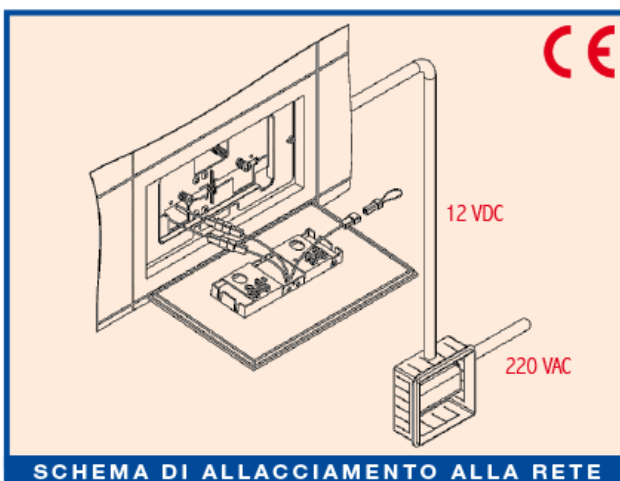

Codice	Descrizione	Listino A	Listino B
1415490201	Cassetta Sfiore Eco Anticondensa 1415490201	243,40 €	270,17 €



Codice	Descrizione	Listino A	Listino B
80140001	Placca Sfiore Bianca 80140001	336,26 €	373,25 €
80140002	Placca Sfiore Verde 80140002	353,08 €	391,92 €
80140003	Placca Sfiore Nera 80140003	353,08 €	391,92 €

PUCCI® eco® 9l - 4l MODULO

PER INSTALLAZIONE DAVANTI A PARETI IN MURATURA O PARETI LEGGERE IN CARTONGESSO-PER WC SOSPESO



1323490201

eco® 9l - 4l
anticondensa

*** 1723490201**

eco® 9l - 4l
anticondensa

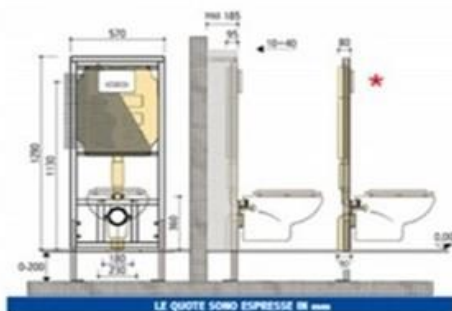

DATI TECNICI

- pressione dinamica 0,1-10 bar
- temperatura massima dell'acqua 25°C
- impostazione predefinita quantità di risciacquo 9-4l
- campo di regolazione risciacquo lungo 9-6l
- campo di regolazione risciacquo breve 4-3l

CAMPI D'APPLICAZIONE

- > Davanti a pareti in muratura ad altezza parziale o totale
- > Pareti leggere in cartongesso
- > Risciacquo a due quantità
- > Per wc sospesi
- * > Pareti leggere in cartongesso 8 cm

CARATTERISTICHE E DOTAZIONE

- > Cassetta in polietilene spessore 8 cm
- > Isolata contro la condensa
- > Rete portaintonaco premontata
- > Comando frontale con risciacquo a due quantità
- > Allacciamento idrico dall'alto disassato a sx
- > Rubinetto di arresto 1/2" con supporto
- > Tubo di risciacquamento 23 x 25 cm con tappo di protezione
- > Tampone in gomma Ø 60-40 mm
- > Manicotto aumento da Ø 40 a Ø 45 mm con OR 143 e morsetto Ø 60-45 mm
- > Confezione lubrificante per guarnizioni
- > Protezione in polistirolo espanso per sportello e particolari interni
- > Telaio autoportante verniciato a polvere
- > Larghezza del profilo del telaio 35 mm
- > Interasse fori di fissaggio vaso 180 e 230 mm
- > 2 barre filettate M12 con dadi per fissaggio vaso
- > Piastre di base zincate da tassellare regolabili da 0 a 200 mm
- > Piastre di base girevoli
- > Collare di riduzione Ø 110-90 mm
- > Curva di scarico in PE Ø 90 mm con guarnizione
- > Tappo di protezione Ø 90 mm
- > Manicotto prolungato Ø 90 mm con guarnizione
- > 2 rondelle con cannottino eccentrico regolazione vaso
- > 2 cappucci di protezione
- > Materiale di fissaggio, staffe e tasselli

Codice	Pezzi	Descrizione
80001330	1	Morsetto combinato Ø 48-58 mm con coprimorsetto - bianco
80001390	1	Gruppo rosone eccentrico - OR 143 canotto 22 cm - bianco
80005560	1	Sfera con tirantino
80005570	1	Batteria completa con sfera
80006010	5	Telaio guida sfera
80006111	1	Sacchetto a corr. alimentazione Eco-Sara
80006400	1	Tubo cacciata 35x11 cm Ø 50-40 mm con rivestimento e tappo
80006501	1	4 staffe con bulloni fissaggio cassetta al muro
80006535	2	Staffa sostegno valvola con vite
80006543	1	Flessibile F.F. con guarnizioni
80006544	1	Rubinetto ottone 1/2" con supporto in polietilene
80006550	1	Gruppo valvola completo
80006554	1	Raccordo valvola con sede interna
80006555	10	Pistoncino con guarnizioni 10x5 mm
80006556	1+1	Leve per valvola
80006560	1	Tubo di risciacquamento 35x11 cm con rivestimento e tappo, regolabile in altezza (+2-2 cm), canotto 22 cm, rosone eccentrico e morsetto combinato Ø 48-58 mm con coprimorsetto - bianco

Codice	Pezzi	Descrizione
80006594	1	Sede estraibile completa di tubetti troppo pieno e telaio guida sfera
80006595	1	Sede estraibile con 2 OR 147 e guarnizione sede
80006596	8	OR 147 per sede estraibile e codulo
80006597	5	Telaio distanziatore
80009038	10	Guarnizione sede sfera
80009074	6	Tubetto troppo pieno 47 cm per tutti i modelli
80130550	1	Placca Eco ellisse bianca 4,7 mm spessore
80130560	1	Placca Eco linea bianca 4,7 mm spessore
80130570	1	Placca Eco tratto bianca 4,7 mm spessore
80130910	1	Dima per montaggio vitoni per placca
80130911	1	Sportello Eco
80130930	2+2	Vite registro e vite fissaggio placca prolungate 7cm
80130933	4	Vite registro
80130981	4	Vite fissaggio placca
80131386	1+1	Manicotto aumento Ø 40-45 mm con OR 143 e morsetto Ø 55-44 mm
80136110	1	Sacchetto a corredo wc Eco-Sara
80170580	1	Placca Eco bianca con telaio
80180510	1	Placca Eco bianca con telaio

Codice	Pz	Listino A	Listino B
1323490201	1	228,75 €	253,91 €

PUCCI[®]eco[®] 9-4

DUE PULSANTI DI SCARICO PER PARETI IN MURATURA - PER WC A PAVIMENTO / TWO PUSH -BUTTONS FLUSH TANK FOR BRICK WALLS - FOR FLOOR MOUNTED BOWL



regolazione tubo
di risciacquamento
dopo l'installazione
4 cm (+2 -2 cm)

rinsing pipe adjustment
4 cm (+2 -2 cm)
after installation

1315490001
eco[®]9/-4/

***1315490201**
eco[®]9/-4/
anticondensa
Anti-condensation

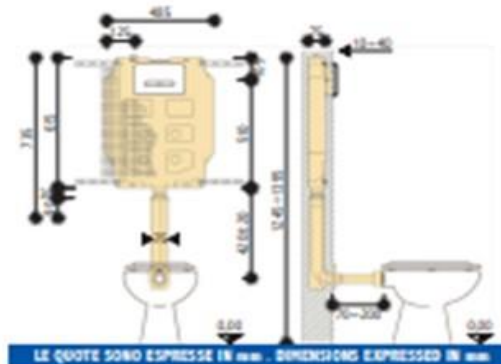

DATI TECNICI / TECHNICAL DATA

pressione dinamica **0,1-10 bar**

dynamic pressure **0,1-10 bar**

temperatura massima dell'acqua **25°C**

maximum water temperature **25°C**

impostazione predefinita quantità di risciacquo **9-4/**

rinsing quantity predetermined setting - out **9-4/**

campo di regolazione risciacquo lungo **9-6/**

long - rinsing regulation range **9-6/**

campo di regolazione risciacquo breve **4-3/**

short - rinsing regulation range **4-3/**

CAMPI D'APPLICAZIONE

- > Per pareti in muratura
- > Per wc a pavimento
- > Risciacquo a due quantità

FIELDS OF APPLICATION

- > For brick walls
- > For floor-mounted bowl
- > Two quantities water rinsing

CARATTERISTICHE E DOTAZIONE

- > Cassetta in polietilene spessore 7,5 cm
- > Rete portaintonaco premontata
- > Comando frontale con risciacquo a due quantità
- > Allacciamento idrico dall'alto disassato a sx
- > Rubinetto di arresto 1/2" con supporto
- > 4 staffe sostegno con viti per fissaggio cassetta
- > Tubo di risciacquamento 35 x 11 cm regolabile in altezza (+2-2 cm)
- > Coppelle di protezione e tappo per la regolazione del tubo di risciacquamento
- > Rosone eccentrico e canotto 22 cm
- > Morsetto combinato Ø 48-58 mm con coprimorsetto
- > Manicotto aumento da Ø 40 a Ø 45 mm con OR 143 e morsetto Ø 55-44 mm
- > Confezione lubrificante per guarnizioni
- > Protezione per sportello e particolari interni
- > Isolata contro la condensa

FEATURES AND EQUIPMENT

- > Polyethylene tank 7,5 cm total thickness
- > Plaster holder pre-built mesh
- > Front control with two quantities rinsing
- > Water connection from above misaligned on the left
- > 1/2" stop cock with support
- > 4 supporting brackets with tank fastening screws
- > 35 x 11 cm adjustable flush pipe (+2-2 cm)
- > Foam protection, covers and cap for rinsing pipe adjustment
- > Eccentric escutcheon and 22 cm joint
- > Ø 48-58 mm combined clamp with clamp cover
- > From Ø 40 mm to Ø 45 extension socket, OR 143 and Ø 55-44 mm clamp
- > Gasket lubricant package
- > Foam protection for door and inner parts
- > * Anti-condensation

PUCCI®eco®

RICAMBI ORIGINALI

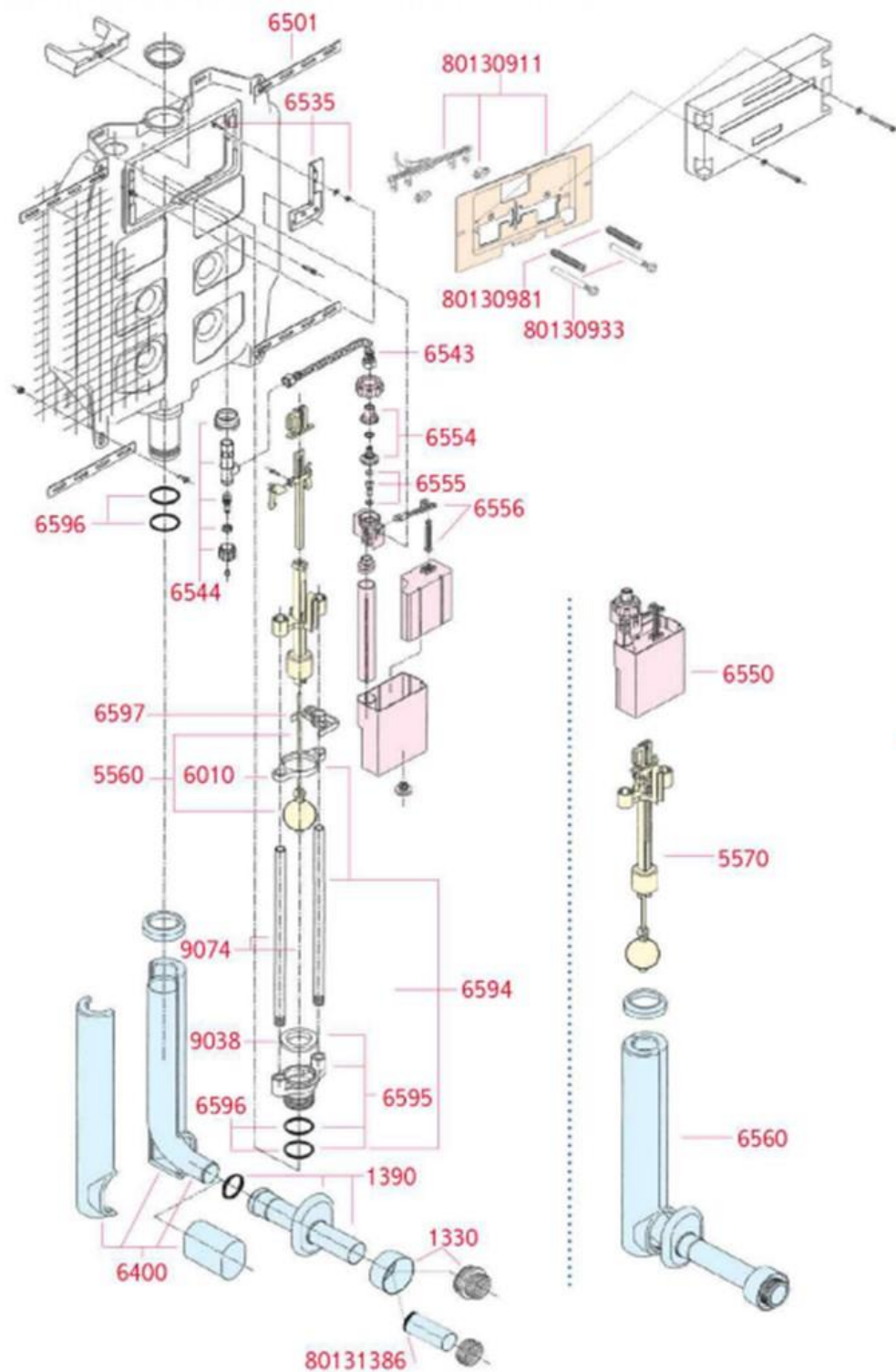

4,7mm



P-0560 P-0562 P-0569



P-0550 P-0552 P-0559



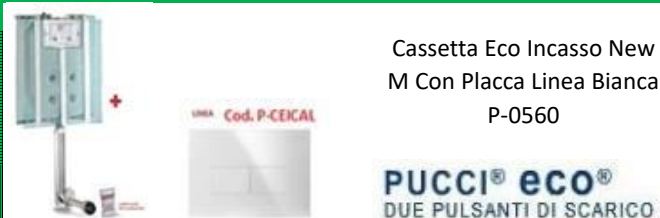

Codice	Riferimenti	Listino A	Listino B	Off.	Pz
P-CEICAL		164,45 €	182,54 €	1	3
P-CEICALx3	Offertax3	154,96 €	172,00 €	3	3
P-CEICALx6	Offertax6	148,63 €	164,98 €	6	3
P-CEICALx9	Offertax9	142,31 €	157,96 €	9	3



Codice	Riferimenti	Listino A	Listino B	Off.	Pz
P-CEICACL		190,44 €	211,39 €	1	3
P-CEICACLx3	Offertax3	179,45 €	199,19 €	3	3
P-CEICACLx6	Offertax6	172,13 €	191,06 €	6	3
P-CEICACLx9	Offertax9	164,80 €	182,93 €	9	3



Codice	Riferimenti	Listino A	Listino B	Off.	Pz
P-CEICA		164,45 €	182,54 €	1	3
P-CEICAx3	Offertax3	154,96 €	172,00 €	3	3
P-CEICAx6	Offertax6	148,63 €	164,98 €	6	3
P-CEICAx9	Offertax9	142,31 €	157,96 €	9	3



Codice	Riferimenti	Listino A	Listino B	Off.	Pz
P-CEICAC		190,44 €	211,39 €	1	3
P-CEICACx3	Offertax3	179,45 €	199,19 €	3	3
P-CEICACx6	Offertax6	172,13 €	191,06 €	6	3
P-CEICACx9	Offertax9	164,80 €	182,93 €	9	3



Codice	Riferimenti	Listino A	Listino B	Off.	Pz
P-CEISP		135,44 €	150,33 €	1	3
P-CEISPx3	Offertax3	127,62 €	141,66 €	3	3
P-CEISPx6	Offertax6	122,41 €	135,88 €	6	3
P-CEISPx9	Offertax9	117,20 €	130,10 €	9	3

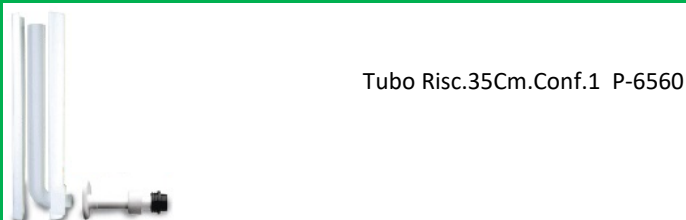

Codice	Riferimenti	Listino A	Listino B	Off.	Pz
P-6560		19,02 €	21,12 €	1	3
P-6560x5	Offertax5	17,93 €	19,90 €	5	3
P-6560x10	Offertax10	17,19 €	19,09 €	10	3
P-6560x15	Offertax15	16,46 €	18,27 €	15	3

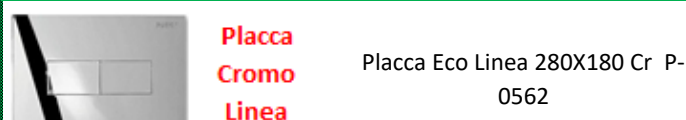

PLACCHE 4,7 mm

Codice	Riferimenti	Listino A	Listino B	Off.	Pz
P-0562		55,00 €	61,05 €	1	3
P-0562x3	Offertax3	51,83 €	57,53 €	3	3
P-0562x6	Offertax6	49,71 €	55,18 €	6	3
P-0562x9	Offertax9	47,60 €	52,83 €	9	3



PLACCHE 4,7 mm

Codice	Riferimenti	Listino A	Listino B	Off.	Pz
P-0560		29,01 €	32,20 €	1	3
P-0560x3	Offertax3	27,34 €	30,34 €	3	3
P-0560x6	Offertax6	26,22 €	29,10 €	6	3
P-0560x9	Offertax9	25,10 €	27,87 €	9	3

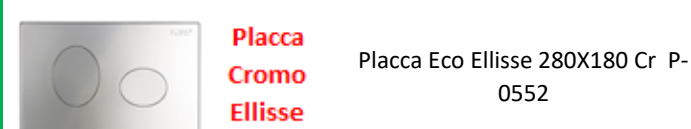

PLACCHE 4,7 mm

Codice	Riferimenti	Listino A	Listino B	Off.	Pz
P-0552		55,00 €	61,05 €	1	3
P-0552x3	Offertax3	51,83 €	57,53 €	3	3
P-0552x6	Offertax6	49,71 €	55,18 €	6	3
P-0552x9	Offertax9	47,60 €	52,83 €	9	3

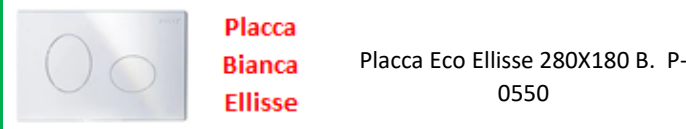

PLACCHE 4,7 mm

Codice	Riferimenti	Listino A	Listino B	Off.	Pz
P-0550		29,01 €	32,20 €	1	3
P-0550x3	Offertax3	27,34 €	30,34 €	3	3
P-0550x6	Offertax6	26,22 €	29,10 €	6	3
P-0550x9	Offertax9	25,10 €	27,87 €	9	3

Codice	Conf.	Riferimenti	Listino A	Listino B
P-1330	1	Morsetto Comb.48-58 Bianco P-1330	€ 6,21	€ 7,19
P-1331	1	Morsetto Comb.48-58 Cromo Pz.1 P-1331	€ 7,45	€ 8,61
P-1390	1	Gruppo Rosone ecc. OR 143 CAN.22 CM. BIANCO CONF.1 ZZ	€ 4,09	€ 4,74
P-1391	1	Gruppo Rosone Ecc.Or143 Can.22Cm. Cromo Conf.1 P-1391	€ 6,90	€ 8,30
P-5410	1	Conf. Eco Placca Eco Pucci P-5410	€ 28,96	€ 36,62
P-5529	1	Telaio Porta Placca Con Viti D.M5 Conf.1 P-5529	€ 9,50	€ 11,43
P-5532	1	Viti Registro Pz. 1 P-5532	€ 2,67	€ 14,71
P-5541	1	Sportello Completo, 2Viti Registro M.8 Conf.1 P-5541	€ 41,42	€ 49,87
P-5560	1	Sfera Con Tiratino Conf.1 P-5560	€ 7,05	€ 8,46
P-5570	1	Batteria Completa Con Sfera Conf.1 P-5570	€ 34,20	€ 39,70
P-6010	5	Telaio Guida Sfera Pz. 1 P-6010	€ 1,15	€ 1,33
P-6110	1	Sacchetto Corredo Wc Eco Sara P-6110	€ 21,45	€ 25,76
P-6111	1	Corredo Aliment. Eco -Sara P-6111	€ 27,40	€ 36,60
P-6281	10	Viti Per Telaio Pz. 1 P-6281	€ 0,46	€ 5,52
P-6400	1	Tube Cacciata 35X11 D.50-40 Con Rivestimento E Tappo P-6400	€ 11,88	€ 13,09
P-6501	1	SERIE DI 4 STAFFE CON BULLONI FISSAGGIO CASSETTA MURO	€ 3,30	€ 3,96
P-6535	2	Conf. Staffa Sost. Vaschetta Pz. 1 P-6535	€ 2,29	€ 5,52
P-6543	1	Pucci Flessibile F.F. Con Guarnizioni Cod. 80006543 P-6543	€ 11,00	€ 13,25
P-6544	2	Rubinetto Ottone Da 1/2"Conf.1 P-6544	€ 16,13	€ 20,34
P-6550	1	GRUPPO VALVOLA COMPLETO	€ 26,91	€ 31,16
P-6554	1	Raccordo Valvola Con Sede Interna P-6554	€ 9,64	€ 10,63
P-6555	10	Pistoncino Con Guarnizione 10X5 Mm Pz. 1 P-6555	€ 1,45	€ 1,60
P-6556	1+1	Leve Per Valvola Conf.5 P-6556	€ 4,17	€ 4,84
P-6560	1	Tube Risc.35Cm.Conf.1 P-6560	€ 16,51	€ 21,12
P-6595	1	Estraibile Con 2Or 147 E Guar. Sede Econf.1 P-6595	€ 9,41	€ 10,92
P-6596	8	OR 147 per sede estraibile e codulo Conf. Pz. 8 Prezzo Pz. 1 P-6596	€ 0,62	€ 5,40
P-9038	10	Guarnizione Sede Sfera Conf. 10 pz Prezzo sinsolo Pz. 1 P-9038	€ 1,83	€ 2,02
P-9074	1	Tube Silenziatore Per Tutti I Modelli P-9074	€ 2,46	€ 17,04
P-0910	1	Dima Per Montaggio Vitoni P-0910	€ 3,84	€ 4,61
P-0911	1	Sportello Eco P-0911	€ 28,00	€ 30,97
P-0930	2+2	Serie Viti Registro E Viti Fissaggio Placca Prolungate 7 Cm P-0930	€ 17,81	€ 19,64
P-0933	4	Viti Registro Pz. 1 P-0933	€ 3,34	€ 14,71
P-0981	4	Viti Fissaggio Placca Pz 1 P-0981	€ 3,33	€ 14,71
P-1386	1+1	Sacchetto A Corredo Manicotto D.40-50Mm D. 45Mm P-1386	€ 10,64	€ 12,78

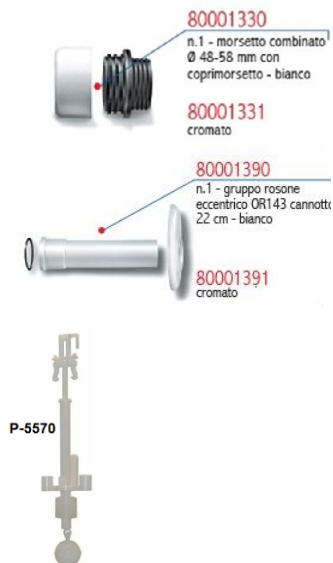

PUCCI® SARA 9ℓ

PULSANTE ALTO PER PARETI IN MURATURA - PER WC A PAVIMENTO



regolazione tubo di risciacquamento
dopo l'installazione 4 cm(+2 -2 cm)

CAMPI D'APPLICAZIONE

- > Per pareti in muratura
- > Per wc a pavimento
- > Risciacquo a una quantità anche a scarico parziale

CARATTERISTICHE E DOTAZIONE

- > Cassetta in polietilene spessore 7,5 cm
- > Rete portaintonaco premontata
- > Comando frontale con risciacquo a una quantità anche a scarico parziale
- > Allacciamento idrico dall'alto disassato a sx
- > Rubinetto di arresto 1/2" con supporto
- > 4 staffe sostegno con viti per fissaggio cassetta
- > Tubo di risciacquamento 35 x 11 cm regolabile in altezza (+2-2 cm)
- > Protezione in polistirolo espanso, coppelle e tappo per la regolazione del tubo di risciacquamento
- > Rosone eccentrico e canotto 22 cm
- > Morsetto combinato Ø 48-58 mm con coprimorsetto
- > Manicotto aumento da Ø 40 a Ø 45 mm con OR 143 e morsetto Ø 55-44 mm
- > Confezione lubrificante per guarnizioni
- > Protezione in polistirolo espanso per sportello e particolari interni
- > Isolata contro la condensa

131500001

SARA 9ℓ

*** 1315000201**

SARA 9ℓ
anticondensa

LE QUOTE SONO ESPRESSE IN mm

DATI TECNICI

pressione dinamica 0,1-10 bar

temperatura massima dell'acqua 25°C

impostazione predefinita quantità di
risciacquo 9ℓ

campo di regolazione risciacquo 9ℓ

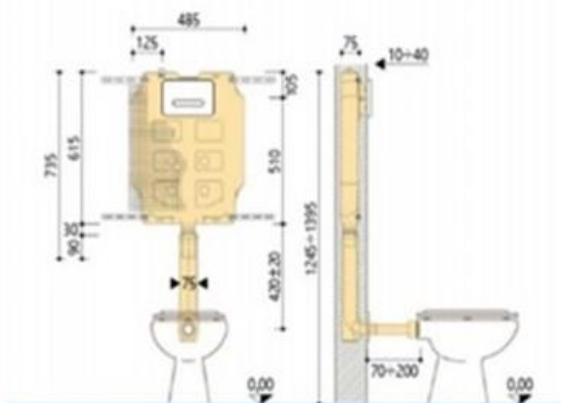

PUCCI SARA®

RICAMBI ORIGINALI

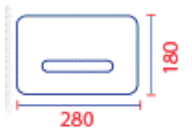
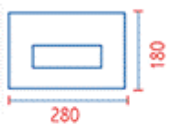
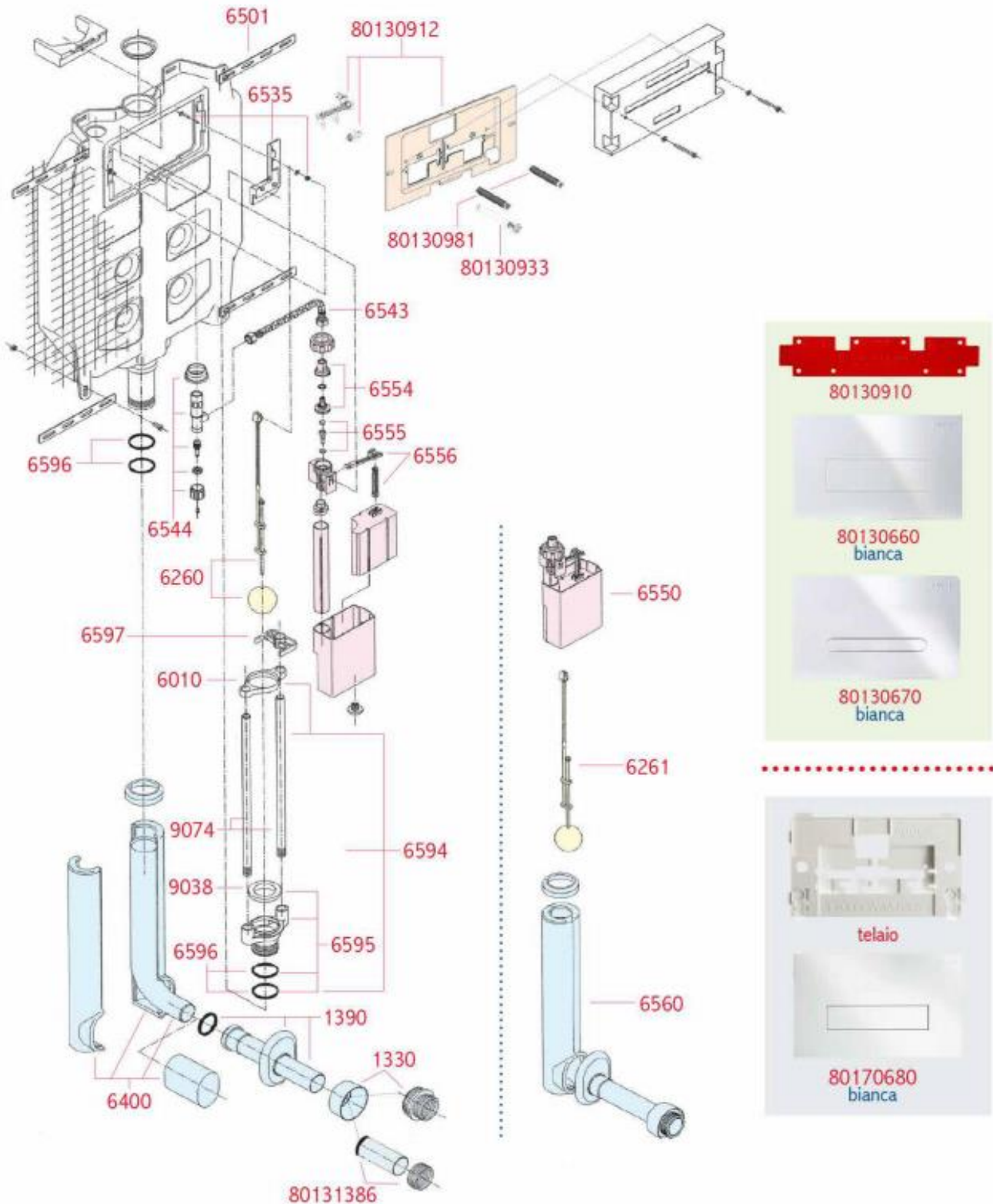

4, 7mm



Sara Inc. New Model Con
Placca Linea Bianca P-0660

PUCCI® SARA 9l
PULSANTE ALTO PER PARETI
IN MURATURA - PER WC



Sara Inc. New Model Con
Placca Linea Cromo P-0662

PUCCI® SARA 9l
PULSANTE ALTO PER PARETI
IN MURATURA - PER WC

Codice	Riferimenti	Listino A	Listino B	Off.	Pz
P-CSCA		117,44 €	130,35 €	1	3
P-CSCAx3	Offertax3	110,21 €	122,33 €	3	3
P-CSCAx6	Offertax6	106,14 €	117,82 €	6	3
P-CSCAx9	Offertax9	101,63 €	112,81 €	9	3

Codice	Riferimenti	Listino A	Listino B	Off.	Pz
P-CSCAC		140,50 €	155,96 €	1	3
P-CSCACx3	Offertax3	131,86 €	146,36 €	3	3
P-CSCACx6	Offertax6	126,99 €	140,96 €	6	3
P-CSCACx9	Offertax9	121,59 €	134,96 €	9	3



Sara Inc. New Model
S/Placca

PUCCI® SARA 9l
PULSANTE ALTO PER PARETI
IN MURATURA - PER WC



Placca Sara Linea Cromo

PLACCHE 4,7 mm

Codice	Riferimenti	Listino A	Listino B	Off.	Pz
P-CSSP		96,14 €	106,72 €	1	3
P-CSSPx3	Offertax3	90,23 €	100,15 €	3	3
P-CSSPx6	Offertax6	86,90 €	96,46 €	6	3
P-CSSPx9	Offertax9	83,20 €	92,35 €	9	3

Codice	Riferimenti	Listino A	Listino B	Off.	Pz
P-0662		44,36 €	49,24 €	1	3
P-0662x3	Offertax3	41,63 €	46,21 €	3	3
P-0662x6	Offertax6	40,09 €	44,50 €	6	3
P-0662x9	Offertax9	38,39 €	42,61 €	9	3

Codice	Conf.	Riferimenti	Listino A
P-1330	1	Morsetto Comb.48-58 Bianco P-1330	€ 6,48
P-1331	1	Morsetto Comb.48-58 Cromo Pz.1 P-1331	€ 7,76
P-1390	1	Gruppo Rosone ecc. OR 143 CAN.22 CM. B. Pz. 1 ZZ	€ 4,27
P-1391	1	GRUPPO ROSONE ECC.OR143 CAN.22CM. CR. Pz.1	€ 7,47
P-5529	1	TELAIO PORTA PLACCA CON VITI D.M5 CONF.1	€ 10,30
P-5532	5	VITI REGISTRO CONF.5	€ 13,25
P-6010	5	TELAIO GUIDA SFERA CONF.5	€ 1,20
P-6111	1	CORREDO ALIMENT. ECO -SARA	€ 32,98
P-6180	1	SALTARELLO PER SPORTELLO CONF1	€ 3,76
P-6240	1	SPORTELLO CON VITE REGISTRO 8M Pz.1	€ 13,08
P-6260	1	SFERA TIRANTINO CONF.1	€ 8,29
P-6261	1	GRUPPO COMPLETO SFERA CON ASTINA CONF.1	€ 11,97
P-6265	1	RIDUTTORE PORTATA X ESTRAIBILE D.40X30 PZ1	€ 13,47
P-6281	1	VITI PER TELAIO CONF.10	€ 4,97
P-6400	1	TUBO CACCIATA 35X11 D.50-40 CON RIVESTIMENTO E TAPPO ZZ	€ 11,80
P-6501	1	SERIE DI 4 STAFFE CON BULLONI FISSAGGIO CASSETTA MURO Pz.1	€ 3,57
P-6535	2	CONF. STAFFA SOST. VASCHETTA	€ 4,97
P-6543	1	FLESSIBILE F.F.CON GUARN.CONF1	€ 11,94
P-6544	1	RUBINETTO OTTONE DA 1/2"CONF.1	€ 18,32
P-6550	1	GRUPPO VALVOLA COMPLETO CONF.1ZZ	€ 28,07
P-6554	1	RACCORDO VALVOLA CON SEDE INTERNA	€ 9,57
P-6555	10	PISTONCINO CON GUARN.CONF.10	€ 1,44
P-6556	1+1	LEVE PER VALVOLA CONF.5	€ 4,36
P-6560	1	TUBO RISC.35CM.CONF.1	€ 19,02
P-6595	1	TRAIBILE CON 2OR 147 E GUAR. SEDE ECONF.1	€ 9,84
P-0910	1	DIMA PER MONTAGGIO VITONIZZ	€ 4,16
P-0912	1	SPORTELLO SARA	€ 21,81
P-0930	2+2	SERIE VITE REGISTRO M8 PR. 7	€ 17,70
P-0933	4	VITI REGISTRO PZ. 4	€ 13,25
P-0981	4	VITI FISSAGGIO PLACCA PZ 2ZZ	€ 13,25
P-1386	2+2	MANICOTTO D.40-50 MORSETTO 55-44	€ 11,52



LINEA bianca
80130660

Placca Sara Linea 280X180 B. P-0660

PLACCHE 4,7 mm

Codice	Riferimenti	Listino A	Listino B	Off.	Pz
P-0660		21,29 €	23,63 €	1	3
P-0660x3	Offertax3	19,98 €	22,18 €	3	3
P-0660x6	Offertax6	19,24 €	21,36 €	6	3
P-0660x9	Offertax9	18,43 €	20,45 €	9	3

Kit di trasformazione per Cassette fino al 2010
Placche 330x180 mm

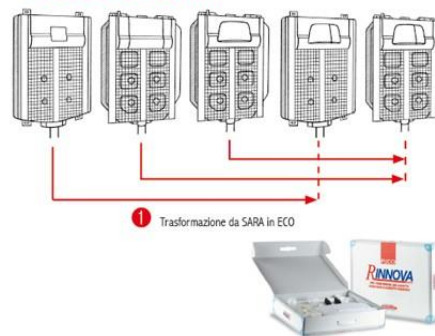

Codice	Conf.	Riferimenti	Listino A
P-5700	1	KIT RINNOVA ECO CON PLACCA BIANCA CONF.1	€ 110,73
P-5702	1	KIT RINNOVA ECO CON PLACCA CROMO CONF.1	€ 128,93

Codice	Conf.	Riferimenti	Listino A
P-6110	1	SACCHETTO CORREDO WC ECO SARA	€ 23,21
P-6596	8	OR147 PER SEDE ESTRAIB. E CODULO CONF.8ZZ	€ 4,87
P-6661	1	GRUPPO COMPLETO SFERA CON ASTINA CONF.1	€ 11,40
P-6910	1	CONF. SARA PLACCA C /TELAIOZZ	€ 23,06
P-9038	10	Guarniz. Sede Pz. 1	€ 1,82
P-9074	1	TUBO SILENZIATORE PER TUTTI I MODELLI CONF.6	€ 15,35

PUCCI® SARA 9ℓ PNEU

PULSANTE PNEUMATICO - PER PARETI IN MURATURA - PER WC A PAVIMENTO



CAMPI D'APPLICAZIONE

- > Per pareti in muratura
- > Per wc a pavimento
- > Risciacquo a una quantità

CARATTERISTICHE E DOTAZIONE

- > Cassetta in polietilene spessore 7,5 cm
- > Rete portaintonaco premontata
- > Gruppo sollevamento sfera pneumatico
- > Risciacquo totale a una quantità
- > A completamento installazione: vedere sezione accessori Pneu
- > Allacciamento idrico dall'alto disassato a sx
- > Rubinetto d'arresto 1/2" con supporto
- > 4 staffe sostegno con viti per fissaggio cassetta
- > Riduzione Ø 50 a Ø 40 mm
- > per tubo di risciacquamento commerciale
- > Confezione lubrificante per guarnizioni
- > Protezione in polistirolo espanso per sportello e particolari interni
- ★ > Isolata contro la condensa

015010031

SARA 9ℓ PNEU

★ 015010231

SARA 9ℓ PNEU
anticondensa

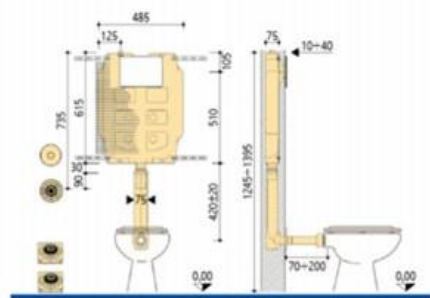

LE QUOTE SONO ESPRESSE IN mm

DATI TECNICI

pressione dinamica 0,1-10 bar

temperatura massima dell'acqua 25°C

impostazione predefinita quantità di risciacquo 9ℓ

campo di regolazione risciacquo 6ℓ

Codice	Pezzi	Descrizione
8000201	1	Telaio porta placca
8000213	1	Sportello PNEU - MATIC
8000710	1	Placca bianca
8000712	1	Placca cromata
8000720	1	Placca acciaio INOX - antivandalo
8000800	1	Placca bianca con telaio
8000802	1	Placca cromata con telaio
8001385	1	Riduzione Ø 50-40 mm per tubo di risciacquamento
80006010	5	Telaio guida sfera
80006281	10	Vite per telaio M5
80006466	1	Tubo di risciacquamento 35x11 cm con rivestimento e tappo, regolabile in altezza (+2-2 cm), canotto 29 cm, rosone eccentrico e morsetto combinato Ø 48-58 mm con coprimeretto - bianco
80006501	1	4 staffe con bulloni fissaggio cassetta al muro
80006535	2	Staffa sostegno valvola con vite
80006543	1	Flessibile F.F. con guarnizioni
80006544	1	Rubinetto ottone 1/2" con supporto polietilene

Codice	Pezzi	Descrizione
80006555	10	Pistoncino con guarnizione 10x5 mm
80006556	1+1	Leve per valvola
80006594	1	Sede estraibile completa di tubetti troppo pieno e telaio guida sfera
80006595	1	Sede estraibile con 2 OR 147 e guarnizione sede
80006596	8	OR 147 per sede estraibile e codolo
80006597	5	Telaio distanziatore
80009038	10	Guarnizione sede sfera
80009074	6	Tubetto troppo pieno 47 cm per tutti i modelli
80009953	5	Guarnizioni semi sfera e guarnizioni antifrizione
80009969	1	Supporto a cannocchiale
80009970	1	Gruppo sollevamento sfera

★ Per una migliore installazione utilizzare il tubo regolabile



PUCCI SARA PNEU

RICAMBI ORIGINALI

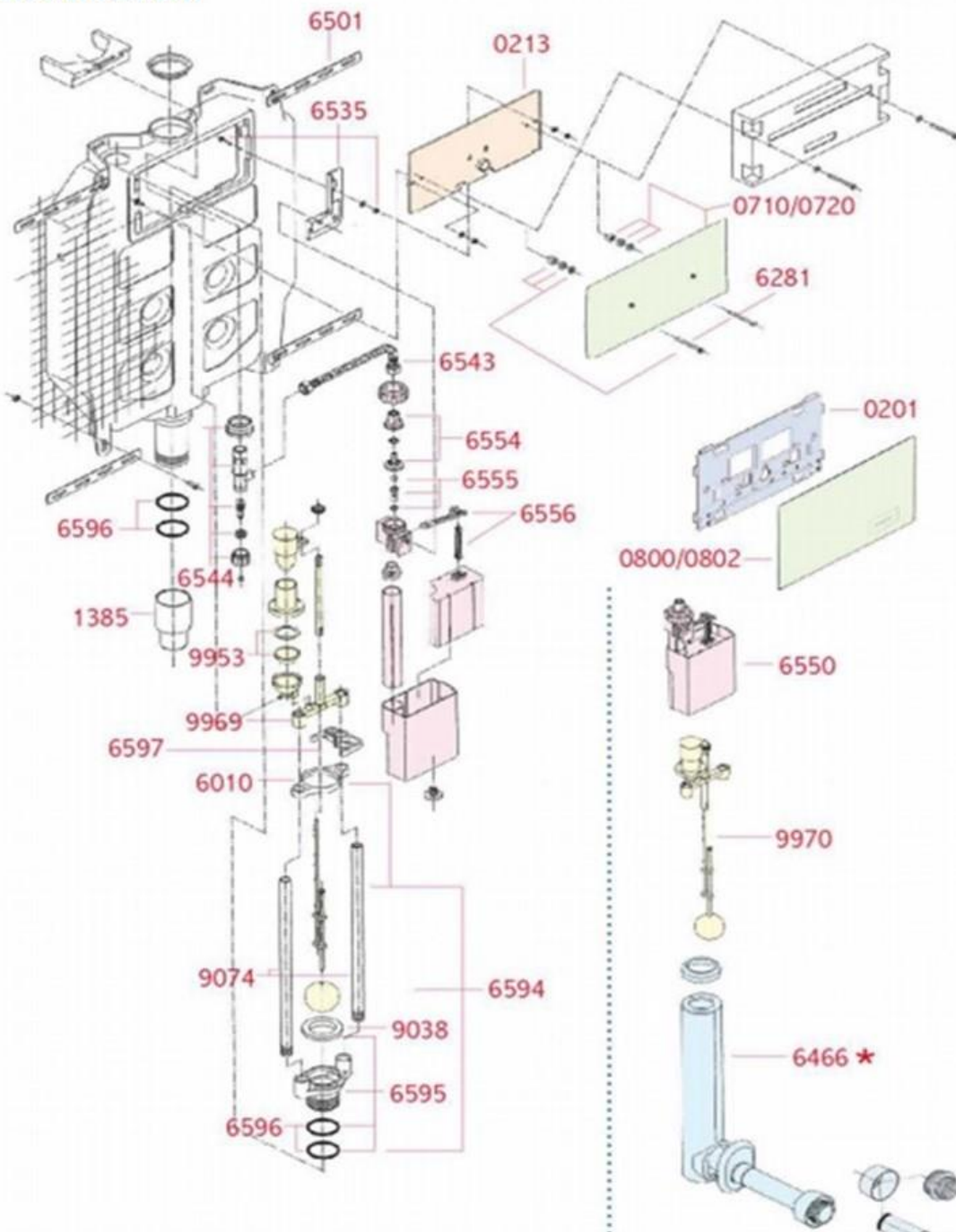

otazione
viti combi M 5 x 50
tappi



80000710
bianca



80000712
cromata



80000720
ciaio inox antivandalo



80000800
bianca



80000802
cromata



80009920
n.1 pulsante PNEU a pedale per
montaggio esterno a pavimento o
a parete con placca in acciaio
inossidabile



80009925
n.1 pulsante PNEU per montaggio
incasso a parete con placca in
acciaio inossidabile



80009900
n.1 pulsante PNEU a parete per
montaggio esterno bianco



80009902
cromato



80009910
n.1 pulsante PNEU a parete per
montaggio a incasso bianco



80009912
cromato

Sara Pneu Pareti in Muratura

Codice	Conf.	Riferimenti	Listino A
P-9900	1	PULSANTE PNEU A PARETE MONT. ESTERNO	€ 32,30
P-9910	1	PULSANTE PNEU A PARETE MONT. INCASSO BIANCO CONF.1	€ 23,93
P-9920	1	PULSANTE PNEU PEDALE MONT. EST+PAV+PAR.PLACCA INOX CONF.1	€ 58,43
P-9925	1	PULSANTE PNEU PEDALE MOT. INC.+PAV.PLACCA INOX CONF. 1	€ 41,94
P-6466		TUBO RISC.KIT COMPL.CONF.1 35X11 ZZ	€ 29,60
P-6476		TUBO RISC.KIT COMPL.CONF.1 45X11ZZ	€ 29,60



80000800
bianca

80000802
cromata

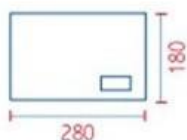

80000710
bianca

80000712
cromata

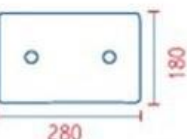

80000720
acciaio

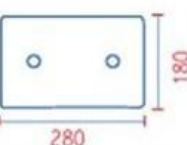

Codice	Conf.	Riferimenti	Listino A
P-0201	1	Telaio Porta Placca	Arrivo
P-0213	1	Sportello PNEU-MATIC	Arrivo
P-0710	1	PLACCA PNEU BIANCA ZZ	Arrivo
P-0712	1	PLACCA PNEU Cromo ZZ	Arrivo
P-0720	1	Placca Acciaio Inox Antivandalò	€ 239,38
P-0800	1	Placca bianca con telaio	Arrivo
P-0802	1	Placca Cromata Con Telaio	Arrivo
P-1385	1	RIDUZIONE D.50-40MM PER TUBO DI RISCIAQC.CONF.1ZZ	€ 4,31
P-6010	5	TELAIO GUIDA SFERA CONF.5	€ 1,20
P-6281	10	VITI PER TELAIO CONF.10	€ 4,97
P-6501	1	SERIE DI 4 STAFFE CON BULLONI FISSAGGIO CASSETTA MURO CONF.1	€ 3,57
P-6466	1	TUBO RISC.KIT COMPL.CONF.1 35X11 ZZ	€ 29,60
P-6535	2	CONF. STAFFA SOST. VASCETTA	€ 4,97
P-6543	1	FLESSIBILE F.F.CON GUARN.CONF.1ZZ	€ 11,94
P-6544	1	RUBINETTO OTTONE DA 1/2"CONF.1	€ 18,32
P-6550	1	GRUPPO VALVOLA COMPLETO CONF.1ZZ	€ 28,07
P-6554	1	RACCORDO VALVOLA CON SEDE INTERNA	€ 9,57
P-6555	10	PISTONCINO CON GUARN.CONF.10	€ 1,44
P-6556	1+1	LEVE PER VALVOLA CONF.5	€ 4,36
P-6595	1	ESTRAIBILE CON 2OR 147 E GUAR. SEDE ECONF.1 ZZ	€ 9,84
P-6596	8	OR147 PER SEDE ESTRAIB. E CODULO CONF.8ZZ	€ 4,87
P-9038	10	Guarniz. Sede conf. 10 ZZ	€ 1,82
P-9074	6	TUBO SILENZIATORE PER TUTTI I MODELLI CONF.6ZZ	€ 15,35
P-9953	5	GUARNIZIONE SEMISFERA E ANTIFRIZIONE CONF.5	€ 6,92
P-9969	1	SUPPORTO A CANNOCCHIALE CONF.1	€ 4,89
P-9970	1	Gruppo sollevamento con sferaZZ	€ 38,75
P-9952	5	GUARNIZIONE LABBRO CONF.5	€ 5,30
P-9954	5	GUARN. SCATOLA PULSANTE PEDALE CONF.5	€ 7,32
P-6265	1	RIDUTTORE PORTATA PER SEDE ESTRAIBILE D.40X30 CONF.1	€ 13,47



NUOVE PLACCHE ECO® DA 12 mm DI SPESSORE
(330 x 180 con telaio porta placca)



Codice	Riferimenti	Listino A	Listino B	Off.	Pz
P-9560	80179560	55,99 €	62,15 €	1	3

NUOVE PLACCHE ECO® DA 12 mm DI SPESSORE
(330 x 180 con telaio porta placca)



Codice	Riferimenti	Listino A	Listino B	Off.	Pz
P-9562	80179562	79,81 €	88,59 €	1	3

NUOVE PLACCHE SARA DA 12 mm DI SPESSORE
(330 x 180 con telaio porta placca)



Codice	Riferimenti	Listino A	Listino B	Off.	Pz
P-9660	80179660	48,91 €	54,29 €	1	3

NUOVE PLACCHE SARA DA 12 mm DI SPESSORE
(330 x 180 con telaio porta placca)



Codice	Riferimenti	Listino A	Listino B	Off.	Pz
P-9662	80179662	71,84 €	79,74 €	1	3

PER SOSTITUZIONE PLACCHE ECO® GIÀ INSTALLATE

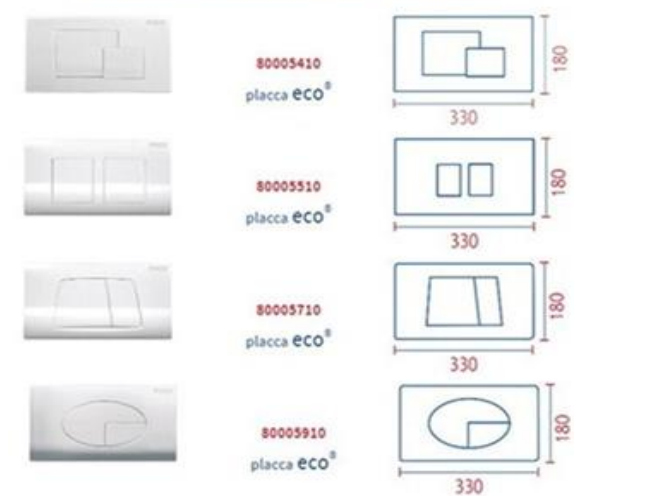

PER SOSTITUZIONE PLACCHE SARA GIÀ INSTALLATE

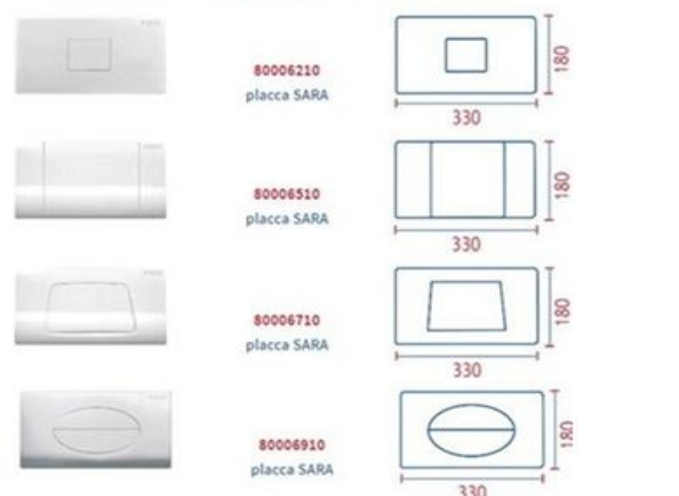

Codice	Riferimenti	Listino A	Listino B	Off.	Pz
P-0580	80170580	32,99 €	36,62 €	1	3
P-0581	80170581	32,99 €	36,62 €	1	3
P-0582	80170582	60,03 €	66,63 €	1	3
P-0589	80170589	60,03 €	66,63 €	1	3
P-0680	80170680	24,21 €	26,87 €	1	3
P-0681	80170681	24,21 €	26,87 €	1	3
P-0682	80170682	48,00 €	53,28 €	1	3
P-0689	80170689	48,00 €	53,28 €	1	3

Codice	Riferimenti	Listino A	Listino B	Off.	Pz
P-0660	80130660	21,29 €	23,63 €	1	3
P-30661	80130661	21,96 €	24,37 €	1	3
P-0662	80130662	44,36 €	49,24 €	1	3
P-0669	80130669	45,74 €	50,78 €	1	3
P-0670	80130670	21,96 €	24,37 €	1	3
P-0672	80130672	45,74 €	50,78 €	1	3
P-0679	80130679	45,74 €	50,78 €	1	3

PUCCI® PLACCHE eco® / SARA la gamma delle placche 280x180 mm spessore 10 mm, con telaio porta placca

PLACCHE SARA 4,7 mm di spessore la gamma delle placche 280 x 180 mm con aggancio diretto allo sportello



PUCCI RAME ■ Rame 10 l Pareti in Muratura

RICAMBI ORIGINALI / ORIGINAL SPARE PARTS

P.6750 Placca Bianca
P.6752 Placca Cromo



Rinnova trasforma cassetta rame pulsante basso in Pulsante Alto

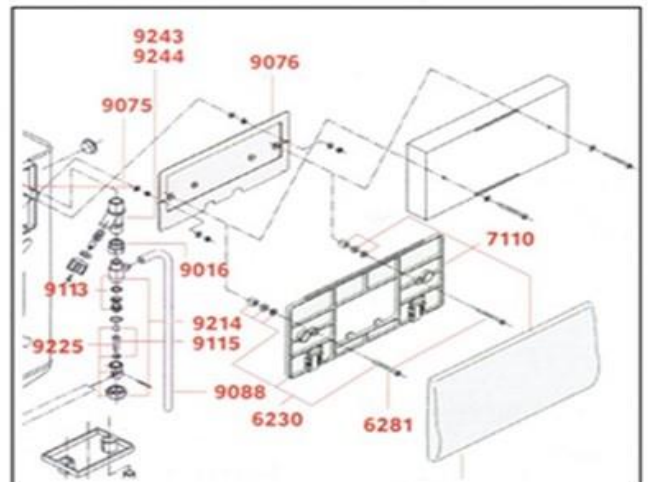
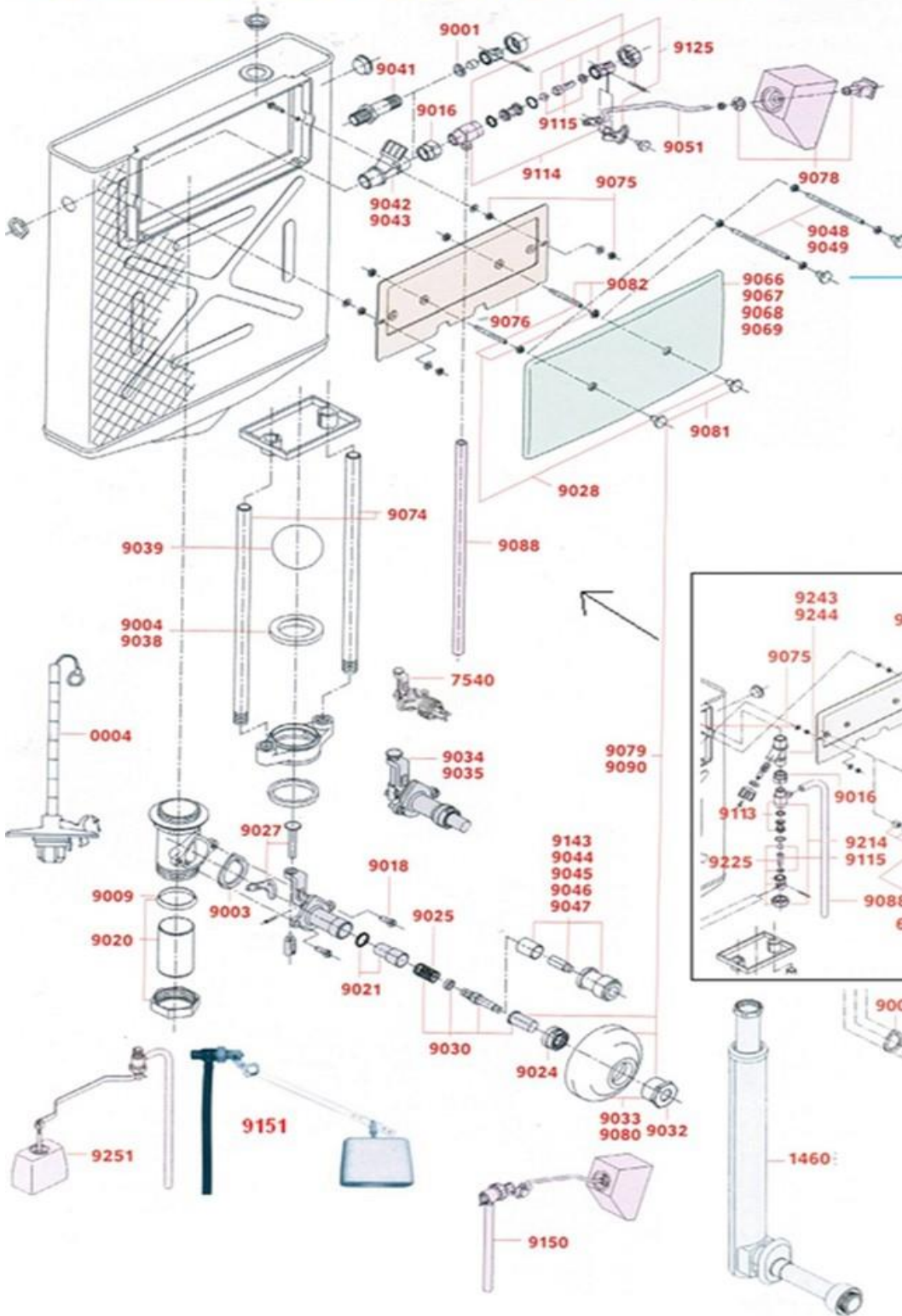
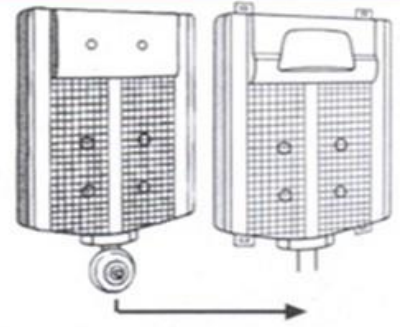

Kit Rinnova Cassetta Rame In Cassetta
Eco Doppio Pulsante P-9200 Placca
Bianca P-9202 Placca Cromo

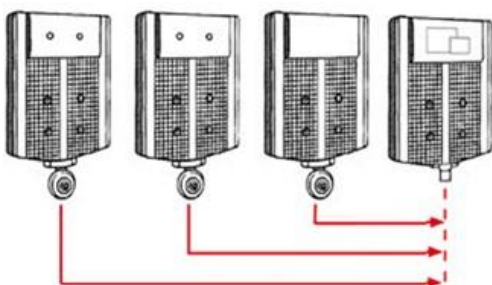

80007510
bianca

80007512
CROMO

Rame 10 | Pareti in Muratura

Codice	Conf.	Riferimenti	Listino A
P-0004	1	ESTRATTORE X GUARN. SEDE	Arrivo
P-1343	1	CODULO PLASTICA 20CM.G. CON.OR3168	€ 6,10
P-1460	1	KIT TUBO RISC.56X11 RIV. COMPLETO BIANCO CONF.1	€ 26,08
P-6230	1	TELAIO PORTA PLACCA CON VITI D.5 DISTANZ.VITE REGISTRO	€ 10,29
P-6281	10	VITI PER TELAIO CONF.10	€ 4,97
P-7110	1	PLACCA COMPL.C.1 BIANCA	€ 21,22
P-7510	1	PLACCA C /TELAIO ROS. FIL. ZZ BOT. E PROL. A 3 CM. BIANCA 7510 CROMO	€ 22,85
P-7512	1	7512	€ 47,12
P-7530	1	PUCCI ROSONE BOTTONE BIAN.7530 "ZC"	€ 7,32
P-7532	1	ROSONE FILETTATO E BOTT.CROMO CONF.1ZZ	€ 21,79
P-7540	1	PULSANTE COMPL. PVC 3 CM.	€ 18,38
P-7541	1	SERIE PULS.CON PIST.MOLLA GUARN.A LABRO SIEGER E PROL. "ZC"	€ 9,29
P-7542	5	MOLLA CILINDRICA IN ACCIAIO	€ 0,69
P-7543	5	SIEGER PULSANTE CONF.5	€ 1,36
P-7545	5	PROLUNGA PULSANTE DA 1CM A 3CM.CONF.5 ZZ	€ 2,94
P-9001	10	CONF. GUARNIZIONE SCODELLINO	€ 0,36
P-9002	10	MENBRANA GOMMA SAGOMATA	€ 1,37
P-9003	10	Guarn. Gomma sagom. 2,5 mm	€ 0,68
P-9004	2	MENBRANA GOMMA SAGOMATA	€ 2,37
P-9005	1	Guarn. Gomma sagom. 2,5 mm	€ 5,29
P-9006	1	MENBRANA GOMMA SAGOMATA	€ 4,89
P-9009	10	GUARNIZ.CONICA CODULO	€ 0,66
P-9016	1	DADO DX/SX GUARN.3 /8 CONF.1	€ 6,08
P-9018	1	BULLONE 1 /4" FISSA PULSANTE AL MANICOTTO CONF.10	€ 0,78
P-9020	10	CODULO IN OTTONE DADO CODULO E GUARNIZIONI CONICA CONF.1	€ 12,81
P-9021	1	BOCCOLINA INTERNA OR 119	€ 1,82
P-9024	5	GHIERA CONF.5ZZ	€ 1,35
P-9025	5	MOLLE ACCIAIO PULSANTE BASSO	€ 0,69
P-9027	10	FORCELLE E FUNGHETTI CONF.10	€ 1,32
P-9030	5	SERIE PULSANTE CONF.1ZZ	€ 6,67
P-9032	5	BOCCOLA CROMO FISSA ROSONE	€ 1,66
P-9033	1	ROSONE BOCCOLA CROMO	€ 0,83
P-9034	10	PULSANTE PUCI UNIV. OTTONE	€ 30,03
P-9035	1	Pulsante completo CASSETTA 6/8	€ 19,67
P-9038	10	Guarniz. Sede conf. 10 ZZ	€ 1,82
P-9039	1	Sfera di tenuta conf. 1	€ 8,10
P-9041	10	RACCORDINO DADO DX-SX	€ 13,05
P-9042	1	RUBINETTO OTT. LAT. 3/8"-6/8-10 l.	€ 10,29
P-9043	1	RUBINETTO OTt. LAT. 3/8"-6/8 14 l.	€ 10,34
P-9044	1	PROLUNGA PULSANTE CM.2	€ 15,51
P-9045	1	PROLUNGA PULSANTE CM.3	€ 16,26
P-9046	1	PROLUNGA PULSANTE CM.4	€ 17,30
P-9047	1	PROLUNGA PULSANTE CM.5	€ 17,85
P-9048	2	GAMBETTI PROL.7 cm. DADI & PAST.	€ 3,47
P-9049	2	GAMBETTI PR..10CM. DADINI & PASTIGLIE	€ 3,84
P-9051	5	ASTINE PER GALLEGGIANTI CONF.5	€ 5,40
P-9057	10	TELAIO GUIDA SFERA CONF.5	€ 1,15
P-9066	1	CONF. PLACCA BIANCA PUCI ZZ	€ 13,95

Codice	Conf.	Riferimenti	Listino A
P-9067	1	PLACCA NERA CONF.1	€ 12,30
P-9069	1	PLACCA CHAMPAGNE	€ 23,99
P-9074	6	Tubo troppo pieno 47 cm T.M	€ 15,35
P-9075	10	Serie per sportello (viti e dadini)	€ 12,98
P-9076	10	CONF. SPORTELLA CON INSERTI	€ 4,44
P-9078	1	Galleggiante in polisterolo	€ 3,57
P-9080	1	Rosone cromato	€ 5,54
P-9081	10	Pastiglie cromate	€ 14,85
P-9082	10	Gambetti e dadini	€ 13,78
P-9083	6	Serie guarn. (sede+menb+fibbra+sc.)	€ 4,16
P-9088	1	TUBO SILENZIATORE TUTTI I MODELLI CONF.6ZZ	€ 0,83
P-9095	10	SEDE ESTRAIBILE CON OR161	€ 7,42
P-9096	5	OR161 PER SEDE ESTRAIBILE	€ 0,99
P-9113	1	CORPO VALVOLA CON SEDE OR113	€ 10,23
P-9114	1	Valvola ATTACCO laterale	€ 15,34
P-9115	10	Pistoncino 10x5 mm	€ 1,46
P-9125	1	TESTINA VALVOLA ATT. CENTRALE	€ 6,10
P-9143	1	PROLUNGA PUCI CM. 1ZZ	€ 14,79
P-9150	1	Valvola completa att. centrale	€ 24,89
P-9214	10	VALVOLA ATTACCO CENTRALE	€ 13,83
P-9225	1	TESTINA VALVOLA ATT. CENTRALE CONF.1	€ 4,74
P-9243	1	RUBINETTO OTTONE ATT.CENTRALE DADO 3 /8 CONF.1	€ 14,92
P-9244	1	Rubinetto ott. At. Cent. Dado 1/2"	€ 16,97
P-9250	1	GALLEGGIANTE ATT.CENTR. FINO 89	€ 27,66
P-9251	1	GALLEGGIANTE ATT.CENTRALE	€ 27,66
P-9532	1	GALLEGGIANTE IN POLISTEROLO	€ 4,16
P-9535	1	VASCHETTA CON VALVOLINA CONF.1	€ 5,24
P-9536	1	STAFFA SOSTEGNO VASCHETTA CON VITE E RONDELLA ZINCATA CONF.5	€ 1,75
P-9244	1	Rubinetto ott. att.Central. DADO 1/2	€ 16,97



Kit Rinnova Cassetta Rame In Cassetta "ECO"

P-9200	1	KIT RINNOVA RAME 10L. IN ECO Placca Biana 5410	€ 111,19
P-9202	1	KIT RINNOVA RAME 10L. IN ECO Placca Cromo 5412	€ 129,46

Kit Rinnova Cassetta Rame In Cassetta "SARA"

P-6750	1	PLACCA SARA C.1 BIANCA	€ 54,52
P-6752	1	PLACCA SARA C.1 CROMO	€ 73,61

Rame 10 | Pareti in Muratura

PROFESSIONALITA' E QUALITA'



EVOKlima™

TECNOLOGIA - BENESSERE - RISPETTO PER L'AMBIENTE

Distributore Ufficiale
Pucciplast

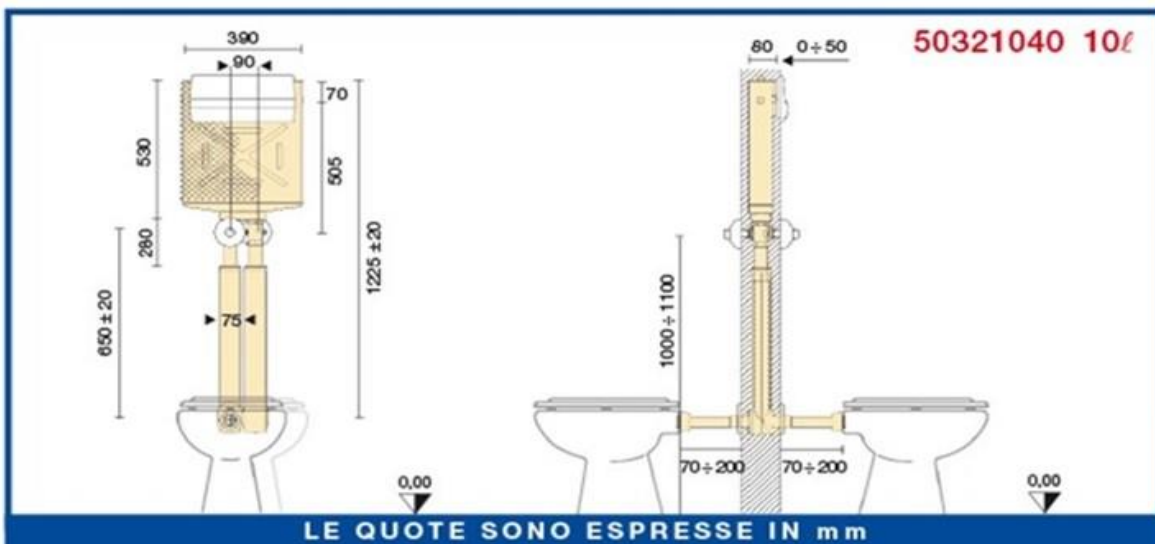
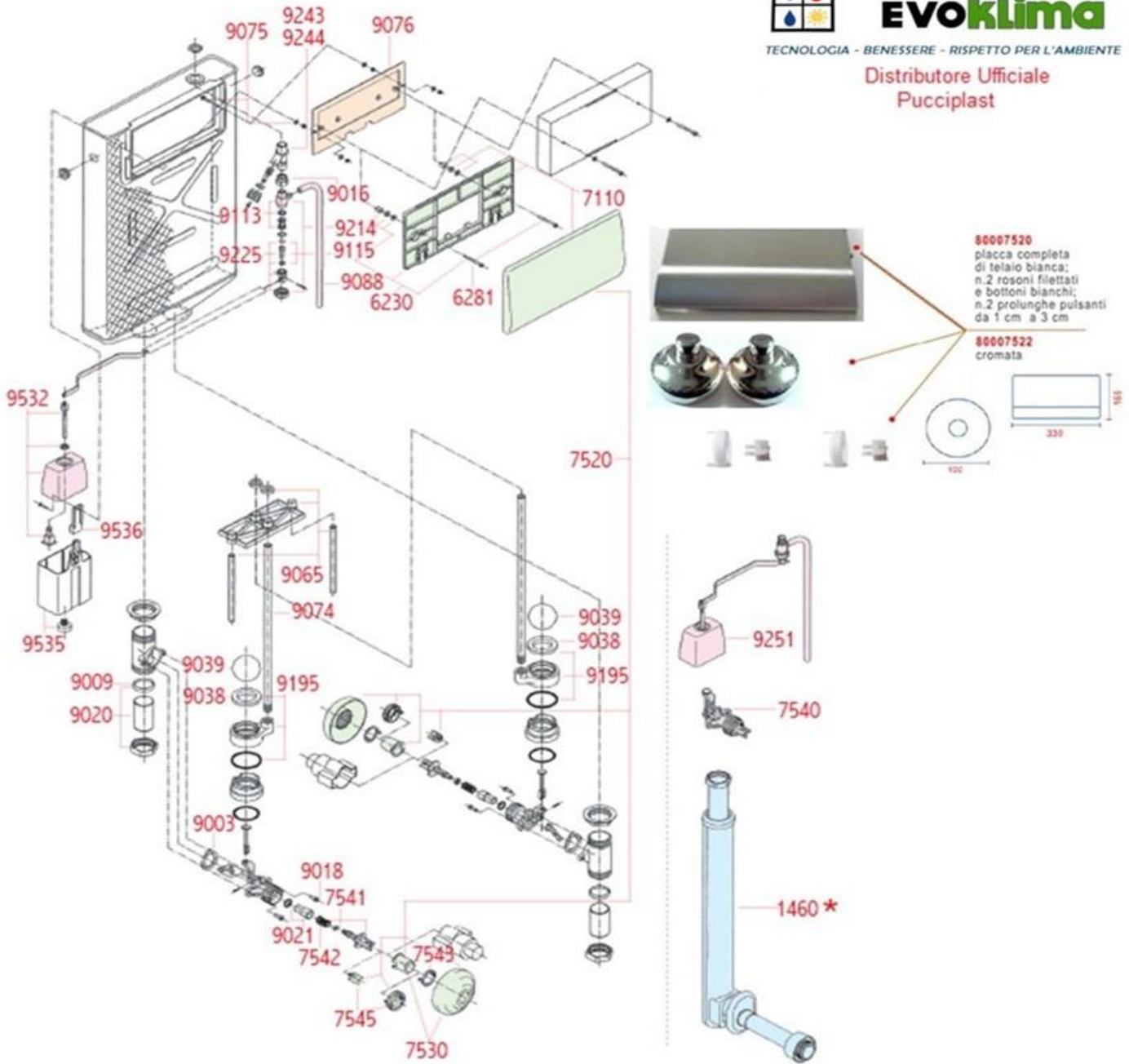



Cassette Incasso Pucci Rame
Completa Di Placca P-7510
Bianca P-CPCA



Placca C /Telaio Ros. Fil. Bot. E
Prol. A 3 Cm. Bianca P-7510

Codice	Riferimenti	Listino A	Listino B	Off.	Pz
P-CPCA		217,39 €	241,30 €	1	3
P-CPCAx3	Offertax3	205,94 €	228,60 €	3	3
P-CPCAx6	Offertax6	195,65 €	217,17 €	6	3
P-CPCAx9	Offertax9	185,35 €	205,74 €	9	3

Codice	Riferimenti	Listino A	Listino B	Off.	Pz
P-7510		22,85 €	25,36 €	1	3
P-7510x3	Offertax3	21,53 €	23,90 €	3	3
P-7510x6	Offertax6	20,65 €	22,92 €	6	3
P-7510x9	Offertax9	19,77 €	21,95 €	9	3



Cassette Incasso Pucci Rame
Con Placca Cromo P-7512 P-
CPCAC



Placca Pucci C /Telaio Ros. Fil.
Bot. E Prol. A 3 Cm. Cromo 7512
Pz 1 P-7512

Codice	Riferimenti	Listino A	Listino B	Off.	Pz
P-CPCAC		241,81 €	268,41 €	1	3
P-CPCACx3	Offertax3	229,08 €	254,28 €	3	3
P-CPCACx6	Offertax6	217,63 €	241,57 €	6	3
P-CPCACx9	Offertax9	206,17 €	228,85 €	9	3

Codice	Riferimenti	Listino A	Listino B	Off.	Pz
P-7512		47,12 €	52,31 €	1	3
P-7512x3	Offertax3	44,41 €	49,29 €	3	3
P-7512x6	Offertax6	42,59 €	47,28 €	6	3
P-7512x9	Offertax9	40,78 €	45,27 €	9	3



Cassette Incasso Pucci Rame
Senza Placca P-CPSP

Codice	Riferimenti	Listino A	Listino B	Off.	Pz
P-CPSP		175,97 €	195,32 €	1	3
P-CPSPx3	Offertax3	165,14 €	183,30 €	3	3
P-CPSPx6	Offertax6	159,05 €	176,54 €	6	3
P-CPSPx9	Offertax9	152,28 €	169,03 €	9	3

Rame 10 | Pareti in Muratura
PUCCI' RAME
PULSANTE BASSO PER VASI ABBINATI - PER PARETI IN MURATURA - PER WC A PAVIMENTO



50321040
RAME 10€
doppio pulsante



Cassette Doppio Pulsante Senza
Placche P-CPDPSP



Codice	Riferimenti	Listino A	Listino B	Off.	Pz
P-CPDPSP		178,26 €	197,87 €	1	3

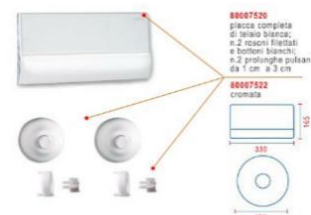

Placca C / Di Telaio, 2 Ros. Fil.
Bott. E Prol. A 3 Cm. B. P-7520

Codice	Riferimenti	Listino A	Listino B	Off.	Pz
P-7520		21,85 €	24,26 €	1	3

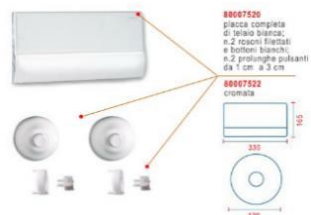

Placca C/Di Telaio, 2 Ros. Fil.
Bott. E Prol. A 3 Cm. Cromo C.1 P-
7522

Codice	Riferimenti	Listino A	Listino B	Off.	Pz
P-7522		45,08 €	50,04 €	1	3

DATI TECNICI / TECHNICAL DATA

pressione dinamica **0,1-10 bar**
dynamic pressure **0,1-10 bar**

temperatura massima dell'acqua **25°C**
maximum water temperature **25°C**

impostazione predefinita quantità di risciacquo **10**
rinsing quantity predetermined setting - out **10**

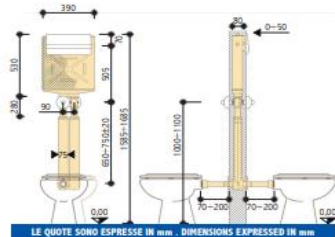



PUCCI SARA 9I MODULO
PER INSTALLAZIONE DAVANTI A
PARETI IN MURATURA O PARETI
LEGGERE IN CARTONGESSO-PER
WC SOSPESO



Codice	Pz	Listino A	Listino B
1323000201	1	192,09 €	213,23 €



PUCCI eco 9I - 4I MODULO PER
INSTALLAZIONE DAVANTI A
PARETI IN MURATURA O PARETI
LEGGERE IN CARTONGESSO-PER
WC SOSPESO Codice
Prod:1323360201



Codice	Pz	Listino A	Listino B
1323490201	1	228,75 €	253,91 €



Sede estraibile completa
di tubetti troppo pieno e
telaio guida sfera Eco
Pucci 80006594

Codice	Pz	Listino A	Listino B
P-6594	1	14,94 €	16,58 €



Cassetta New Eco
Esterna P-CEE



Codice	Pz	Listino A	Listino B
P-CEE	1	89,04 €	98,84 €



Cassetta Viva Bianca Esterna
P-CVB



Codice	Pz	Listino A	Listino B
P-CVB	1	60,30 €	66,93 €



Galleg.Completo Att.Laterale Conf.1 P-9151

Codice	Pz	Listino A	Listino B
P-9151	1	27,76 €	30,81 €

Galleggiante Att.Centrale Fino 89 Conf.1 P-9250



Codice	Off.	Listino A	Listino B
P-9250	1	27,66 €	30,71 €

Galleggiante Pucci Universale P-9150



Codice	Off.	Listino A	Listino B
P-9150	1	24,89 €	27,63 €
P-9150x10	10	23,88 €	26,50 €

Galleggiante In Polistirolo P-9078



Codice	Off.	Listino A	Listino B
P-9078	1	3,57 €	3,96 €

Valvola Attacco Centrale Conf.1 P-9214



Codice	Off.	Listino A	Listino B
P-9214	1	13,83 €	15,35 €

Conf. Guarnizione Scodellino Conf. 10 pz
Prezzo Pz 1 P-9001



Codice	Off.	Listino A	Listino B
P-9001	1	0,36 €	0,40 €

Dado Dx/Sx Guarn.3/8" Conf.1 P-9016



Codice	Off.	Listino A	Listino B
P-9016	1	6,08 €	6,75 €

Pulsante Compl. Pvc 3 Cm. P-7540



Codice	Off.	Listino A	Listino B
P-7540	1	18,38 €	20,40 €

Pulsante Completo Cassetta 6/8 Conf.1 P-9035



Codice	Off.	Listino A	Listino B
P-9035	1	19,67 €	21,84 €

Pulsante Pucci Univ. Ottone P-9034



Codice	Off.	Listino A	Listino B
P-9034	1	30,03 €	33,33 €
P-9034x10	10	28,80 €	31,97 €



Serie Pulsante Conf.1 P-9030



Codice	Off.	Listino A	Listino B
P-9030	1	6,67 €	7,40 €

Guarizione Gomma Sagomata 2,5 Mm Conf. Pz 5 Prezzo Pz. 1 P-9003



Codice	Off.	Listino A	Listino B
P-9003	1	0,68 €	0,76 €

Ghiera Conf. 5 Prezzo Pz. 1 P-9024



Codice	Off.	Listino A	Listino B
P-9024	1	1,35 €	1,50 €

Prolunga Pucci Cm. 1 P-9143



Codice	Off.	Listino A	Listino B
P-9143	1	14,79 €	16,42 €

Prolunga Pulsante Cm.2 Conf.1 P-9044



Codice	Off.	Listino A	Listino B
P-9044	1	15,51 €	17,21 €

Prolunga Pulsante Cm.3Conf.1 P-9045

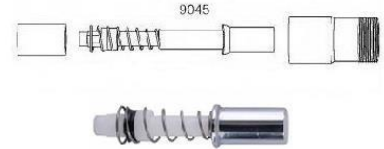

Codice	Off.	Listino A	Listino B
P-9045	1	16,26 €	18,05 €

Boccola Cromo Fissa Rosone Pz. 1 P-9032



Codice	Pz	Listino A	Listino B
P-9032	1	1,66 €	1,84 €

Rosone Boccola Cromo Pucci P-9033



Codice	Pz	Listino A	Listino B
P-9033	1	0,83 €	0,92 €

Sieger Pulsante Pz. 1 P-7543



7541

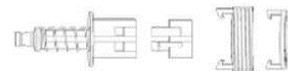

Codice	Pz	Listino A	Listino B
P-7543	1	1,36 €	1,51 €

Prolunga Pulsante Da 3Cm A5 P-7547



80007547
n.1 prolunga da 3 a 5 cm

Codice	Off.	Listino A	Listino B
P-7547	1	9,04 €	10,03 €

Pucci Rosone Bottone Bian.7530 P-7530



Codice	Off.	Listino A	Listino B
P-7530	Bianco	7,32 €	8,12 €
P-7532	Cromo	21,79 €	24,19 €

Serie Puls.Con Pist.Molla Guarn.A Labro Sieger E Prol. P-7541

7541



Codice	Off.	Listino A	Listino B
P-7541	1	9,29 €	10,32 €

Serie Guarnizione fondo piu' guarnizione scodellino galleggiante piu' membrana KGFTP



Codice	Off.	Listino A	Listino B
KGFTP	1	4,25 €	4,72 €

Guarnizione Sede Sfera Conf. 10 pz Prezzo sinsolo Pz. 1 P-9038



Guarda Video Montaggio



Codice	Off.	Listino A	Listino B
P-9038	1	1,82 €	2,02 €
P-9038x10	10	1,75 €	1,95 €

Sfera Di Tenuta Conf. 1 P-9039



Codice	Off.	Listino A	Listino B
P-9039	1	8,10 €	8,99 €

Pistoncino Pz. 1 P-9115



Codice	Off.	Listino A	Listino B
P-9115	10	1,46 €	1,62 €

Pistoncino Con Guarnizione 10X5 Mm Pz. 1 P-6555



Guarda Video Montaggio



Codice	Off.	Listino A	Listino B
P-6555	10	1,44 €	1,60 €

Or161 Per Sede Estraibile Pz. 1 P-9096

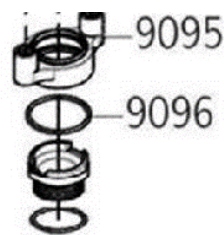

Codice	Off.	Listino A	Listino B
P-9096	10	0,99 €	1,10 €



Leve Per Valvola Conf.5 P-6556

Codice	Off.	Listino A	Listino B
P-6556	5	4,36 €	4,84 €



Gruppo Sollevamento Con Sfera P-9970

Codice	Off.	Listino A	Listino B
P-9970	1	38,75 €	43,01 €



Batteria Completa Con Sfera Conf.1 P-5570

Codice	Off.	Listino A	Listino B
P-5570	1	35,77 €	39,70 €

Estraibile Con 2Or 147 E Guar. Sede Econf.1 P-6595



Codice	Off.	Listino A	Listino B
P-6595	1	9,84 €	10,92 €

Gruppo Completo Sfera Con Astina Conf.1 P-6261



Rame Polietilene 6/8 Prod. fino all'83

Codice	Off.	Listino A	Listino B
P-6261	1	11,97 €	13,29 €

Gruppo Rosone Ecc. Or 143 Can.22 Cm. Bianco Conf.1 P-1390



Codice	Off.	Listino A	Listino B
P-1390	1	4,27 €	4,74 €

Placca Eco Linea 280X180 Nero P-0561



Codice	Off.	Listino A	Listino B
P-0561	1	29,92 €	33,21 €

Pucci Eco Rinnova 28x18 placca di Comando Bianca | 80179580



Codice	Off.	Listino A	Listino B
P-9580	1	55,76 €	61,90 €

Pucci Eco Rinnova 28x18 placca di comando Cromo Lucido | 80179582



Codice	Off.	Listino A	Listino B
P-9582	1	79,49 €	88,23 €

Kit Tubo Risc.56X11 Riv. Completo Bianco Conf.1 P-1460



80001460

n.1 - tubo di risciacquamento 56x11 cm con rivestimento e tappo regolabile in altezza (+2-2 cm), codulo in plastica, canotto 22 cm, rosone eccentrico e morsetto combinato Ø48-58 mm con coprimorsetto - bianco

Codice	Off.	Listino A	Listino B
P-1460	1	26,08 €	28,95 €

Pucci Sara Rinnova 28x18 placca di comando Bianca | 80179680



Codice	Off.	Listino A	Listino B
P-9680	1	48,71 €	54,07 €

Pucci Sara Rinnova 28x18 placca di comando Cromo Lucido | 80179682



Codice	Off.	Listino A	Listino B
P-9682	1	71,55 €	79,42 €



Rubinetto Ottone Da 1/2" Conf.1 P-6544



Codice	Off.	Listino A	Listino B
P-6544	1	18,32 €	20,34 €

Gruppo Valvola Compl. Conf.1 P-5250



Codice	Off.	Listino A	Listino B
P-5250	1	28,73 €	31,89 €



Gruppo Valvola Completo Conf.1 P-6550

GALLEGGIANTE PUCCI PER CASSETTA A INCASSO ECO 8006550

Codice	Off.	Listino A	Listino B
P-6550	1	28,07 €	31,16 €

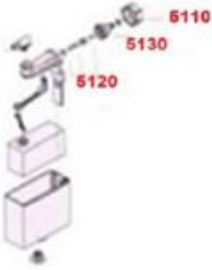

Pistoncino Con Guarn. Pz. 1 P-5120

Codice	Off.	Listino A	Listino B
P-5120	1	14,25 €	15,82 €



Curva 31X19,5Cm. 50-40 Bianca P-3320

Codice	Off.	Listino A	Listino B
P-3320	1	13,82 €	15,34 €



Batteria Scarico Completa Viva P-3110

Codice	Off.	Listino A	Listino B
P-3110	1	20,81 €	23,10 €



Guarnizione Fondo In Para Pz.1 P-3130

Codice	Off.	Listino A	Listino B
P-3130	10	13,59 €	15,08 €



Guarnizione Di Fondo Ø 54X26X3 Mm Fino Al '91 Abs Pz. 1 P-4230

Codice	Off.	Listino A	Listino B
P-4230	10	8,63 €	9,58 €



Guarnizione Di Fondo Ø 63X31X3 Mm Nova - Abs Pz. 1 P-4231

Codice	Off.	Listino A	Listino B
P-4231	10	8,63 €	9,58 €

Morsetto Comb.48-58 Bianco P-1330



80001330 n.1 - morsetto combinato Ø 48-58 mm con coprimorsetto - bianco
80001331 cromato

Codice	Off.	Listino A	Listino B
P-1330	Bianco	6,48 €	7,19 €
P-1331	Cromo	7,76 €	8,61 €



Gruppo Sollevamento Batteria P-4970

Codice	Off.	Listino A	Listino B
P-4970	1	18,19 €	20,19 €

Telaio Guida Sfera Pz. 1 P-6010

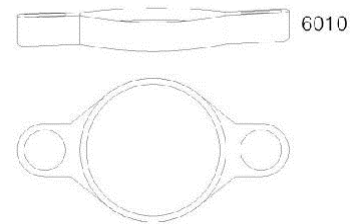

Codice	Off.	Listino A	Listino B
P-6010	1	1,20 €	1,33 €



Rubinetto Gallegian. Att.Basso Da 3/8" Con Sfera T /Ottone RGAB3\8C

Codice	Off.	Listino A	Listino B
RGAB3\8C	3/8"	10,00 €	11,10 €
RGAB1\2C	1/2"	10,30 €	11,43 €

Confezione Sportello Con Inserti M5 conf. 5 pz Prezzo Pz. 1 P-9076



Gambetti Prolung.10Cm. Dadini & Pastiglie Pz. 1 P-9049



P-9049

Codice	Off.	Listino A	Listino B
P-9076	1	4,44 €	4,93 €
P-9049	1	3,84 €	4,27 €

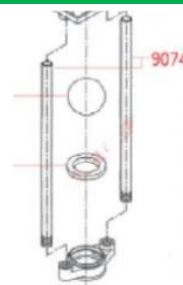

Tubo Silenziatore Per Tutti I Modelli P-9074

Codice	Off.	Listino A	Listino B
P-9074	1	15,35 €	17,04 €



Nuova Cassetta Av1 80Mm
38863000



Codice	Riferimenti	Listino A	Listino B	Off.	Box
38863000		160,08 €	177,69 €	1	3
38863000x3	Offertax3	149,41 €	165,85 €	3	3
38863000x6	Offertax6	142,30 €	157,95 €	6	3
38863000x9	Offertax9	131,62 €	146,10 €	9	3



Skate Cosmopolitan Piastra Di
Azionamento Cromata
38732000



Codice	Riferimenti	Listino A	Listino B	Off.	Box
38732000		82,64 €	91,73 €	1	3
38732000x3	Offertax3	77,13 €	85,62 €	3	3
38732000x6	Offertax6	73,46 €	81,54 €	6	3
38732000x9	Offertax9	67,95 €	75,42 €	9	3



Skate Cosmopolitan Piastra Di
Azionamento Bianca 38732SH0



Codice	Riferimenti	Listino A	Listino B	Off.	Box
38732SH0		67,61 €	75,05 €	1	3
38732SH0x3	Offertax3	63,11 €	70,05 €	3	3
38732SH0x6	Offertax6	60,10 €	66,71 €	6	3
38732SH0x9	Offertax9	55,59 €	61,71 €	9	3

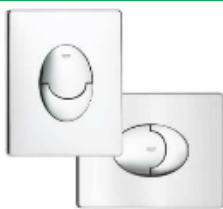

Skate Air Piastra Di Azionamento
Cromata 38505000



Codice	Riferimenti	Listino A	Listino B	Off.	Box
38505000		76,36 €	84,75 €	1	3
38505000x3	Offertax3	71,26 €	79,10 €	3	3
38505000x6	Offertax6	67,87 €	75,34 €	6	3
38505000x9	Offertax9	62,78 €	69,69 €	9	3



Skate Air Piastra Di Azionamento
Bianca 38505SH0



Codice	Riferimenti	Listino A	Listino B	Off.	Box
38505SH0		59,19 €	65,70 €	1	3
38505SH0x3	Offertax3	56,07 €	62,24 €	3	3
38505SH0x6	Offertax6	53,27 €	59,13 €	6	3
38505SH0x9	Offertax9	50,47 €	56,02 €	9	3



Cassetta 0,82 Cm Per 38415000
Cassetta 0,82 Cm Per Wc
38422000



Codice	Riferimenti	Listino A	Listino B	Off.	Box
38422000		220,13 €	244,35 €	1	3
38422000x3	Offertax3	205,46 €	228,06 €	3	3
38422000x6	Offertax6	195,67 €	217,20 €	6	3
38422000x9	Offertax9	181,00 €	200,91 €	9	3



Uniset 80Mm Per Wc Con
Cass.Av1 38729000



Codice	Riferimenti	Listino A	Listino B	Off.	Box
38729000		251,66 €	279,34 €	1	3
38729000x3	Offertax3	234,88 €	260,72 €	3	3
38729000x6	Offertax6	223,70 €	248,30 €	6	3
38729000x9	Offertax9	206,92 €	229,68 €	9	3



Grohe Cassetta Di Sciacquo Per
Wc, Bianco 38372SH0



Codice	Riferimenti	Listino A	Listino B	Off.	Box
38372SH0		85,90 €	95,35 €	1	3
38372SH0x3	Offertax3	80,17 €	88,99 €	3	3
38372SH0x6	Offertax6	76,36 €	84,76 €	6	3
38372SH0x9	Offertax9	70,63 €	78,40 €	9	3



Canotto + Morsetto X 37104K
42250000



Codice	Riferimenti	Listino A	Listino B	Off.	Box
42250000		14,74 €	16,36 €	1	3
42250000x3	Offertax3	13,76 €	15,27 €	3	3
42250000x6	Offertax6	13,10 €	14,55 €	6	3
42250000x9	Offertax9	12,12 €	13,45 €	9	3



Set Alimentazione Acqua
Canotto Per Cassetta 37103SH0



Codice	Riferimenti	Listino A	Listino B	Off.	Box
37103SH0		16,64 €	18,47 €	1	3
37103SH0x5	Offertax5	15,76 €	17,50 €	5	3
37103SH0x10	Offertax10	14,97 €	16,62 €	10	3
37103SH0x15	Offertax15	14,19 €	15,75 €	15	3



Skate
Cosmopolitan
Piastra Di
Azionamento
Acciaio Inox
38732SD0



Skate
Cosmopolitan
Piastra Di
Azionamento Nero
Ultra Opaco
38732KF0



Skate
Cosmopolitan
Piastra Di
Azionamento Oro
Lucido 38732GL0



Codice	Off.	Listino A	Listino B	Codice	Off.	Listino A	Listino B	Codice	Off.	Listino A	Listino B
38732SD0	1	231,44 €	256,90 €	38732KF0	1	225,83 €	250,68 €	38732GL0	1	208,28 €	231,19 €
38732SD02	2	217,83 €	241,79 €	38732KF02	2	212,55 €	235,93 €	38732GL02	2	196,03 €	217,59 €



Skate
Cosmopolitan
Piastra Di
Azionamento Oro
Rosa Spazzolato
38732DL0



Skate
Cosmopolitan
Piastra Di
Azionamento Oro
Spazzolato
38732GN0



SKATE
COSMOPOLITAN
PIASTRA DI
AZIONAMENTO
nichel spazzolato



Codice	Off.	Listino A	Listino B	Codice	Off.	Listino A	Listino B	Codice	Off.	Listino A	Listino B
38732DL0	1	208,28 €	231,19 €	38732GN0	1	208,28 €	231,19 €	38732EN0	1	218,72 €	242,78 €
38732DL02	2	196,03 €	217,59 €	38732GN02	2	196,03 €	217,59 €	38732EN02	2	218,72 €	242,78 €



Valvola Av1
Completa Valvola
Av1 Completa
42320000



Valv. Scaric. Valv.
Scaric 43992000



Valv. Scaric. Valv.
Scaric 43486000



Codice	Off.	Listino A	Listino B	Codice	Off.	Listino A	Listino B	Codice	Off.	Listino A	Listino B
42320000	1	56,97 €	63,24 €	43992000	1	51,38 €	57,03 €	43486000	1	21,63 €	24,01 €
423200002	2	53,62 €	59,52 €	439920002	2	48,36 €	53,68 €	434860002	2	20,36 €	22,60 €



Valv. Carico Valv.
Carico 37092000



Valvola E Cestello
Per 37594/38661
42253000



Riduttore Di Flusso
Per Cassette
42300000



Codice	Off.	Listino A	Listino B	Codice	Off.	Listino A	Listino B	Codice	Off.	Listino A	Listino B
37092000	1	47,03 €	52,21 €	42253000	1	64,90 €	72,04 €	42300000	1	19,81 €	21,99 €
370920002	2	44,27 €	49,14 €	422530002	2	61,08 €	67,80 €	423000002	2	18,65 €	20,70 €

Guarnizione Per Valvola Di Scarico Grohe
42310000 42310000



Cartuccia Ceramica
28Mm Cartuccia
46580000



Canotto + Morsetto X 37104K 42250000



Codice	Off.	Listino A	Listino B	Codice	Off.	Listino A	Listino B	Codice	Off.	Listino A	Listino B
42310000	1	5,41 €	6,00 €	46580000	1	54,09 €	60,03 €	42250000	1	14,74 €	16,36 €
423100002	2	5,09 €	5,65 €	465800002	2	50,90 €	56,50 €	422500002	2	13,76 €	15,27 €



Bauedge Set Miscel.
Monocomando Vasca Inc.
Doccia Grohe



Codice	Riferimenti	Listino A	Listino B	Off.	Box
29079000		131,43 €	145,88 €	1	5



Bauedge Miscelatore
Monocomando Bidet Grohe



Codice	Riferimenti	Listino A	Listino B	Off.	Box
23331000		68,06 €	75,55 €	1	5



Bauedge
Miscelatore Monocomando
Lavabo Taglia M Grohe



Codice	Riferimenti	Listino A	Listino B	Off.	Box
23758000		82,14 €	91,18 €	1	5



Bauedge Miscelatore
Monocomando Bidet Grohe



Codice	Riferimenti	Listino A	Listino B	Off.	Box
23331000		68,06 €	75,55 €	1	5

Cassetta di sciacquo per WC spessore 80 mm | GROHE

COMPATIBILE CON LE PIÙ PICCOLE PIASTRE DI AZIONAMENTO SUL MERCATO

Dima di montaggio per piastra di piccole dimensioni 40 949 000 da acquistare separatamente

VALVOLA DI CARICO ULTRA SILENZIOSA

Il gruppo d'insonorizzazione

CASSETTA

Cassetta rinforzata per prevenire deformazioni in fase di montaggio



RUBINETTO D'ARRESTO

Attacco alto all'acqua

AZIONAMENTO

Azionamento pneumatico: valvola di scarico AV1 con 3 tipologie di sciacquo: Dual Flush, Start&Stop e solo uno sciacquo.

DIMA DI MONTAGGIO

Dima di montaggio in plastica da 50 mm. adattabile a qualsiasi tipo di rivestimento

MATERIALI

PE con rivestimento in resina vinilica per una migliore presa dell'intonaco e anticondensa

TUBO DI CACCIATA

Regolabile in altezza
Copertura in polistirolo

Cassetta Wc di Scarico ad Incasso Grohe Uniset Per Sanitari Sospesi

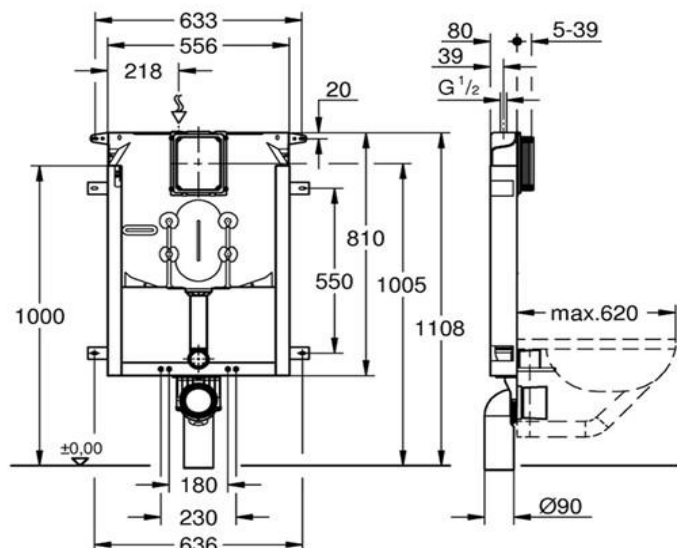



Mobili per il Bagno Componibili per Cucina & Lavanderia



Collection Elegance



Componibili per cucina e lavanderia



Mobile Dream con sportelli e piedini Completo di lavabo e specchio reversibile senza lead



Codice	Riferimenti	Off.	Listino A	Listino B
DREAM60APPSI	Mobile Completo cm. 60	1	308,45 €	326,95 €
DREAM80APPSI	Mobile Completo cm. 80	1	328,94 €	348,68 €
DREAM100APPSI	Mobile Completo cm. 100	1	404,85 €	429,14 €

Sigla Disponibilità colori

- BT Bianco Titanio
- BE Bengala
- CE Cemento
- DV Dolce Vita
- OS Ossido
- SH Sherwood
- SI Signal

Mobile Dream con sportelli Sospeso Completo di lavabo e specchio reversibile senza lead



Codice	Riferimenti	Off.	Listino A	Listino B
DREAM60SI	Mobile Completo cm. 60	1	269,94 €	286,13 €
DREAM80SI	Mobile Completo cm. 80	1	295,63 €	313,37 €

Sigla Disponibilità colori

- BT Bianco Titanio
- BE Bengala
- CE Cemento
- DV Dolce Vita
- OS Ossido
- SH Sherwood
- SI Signal

Mobile Eirene con 3 cassetti e piedini Completo di lavabo e specchio reversibile senza lead



Codice	Riferimenti	Off.	Listino A	Listino B
EIRENE60APP3CSI	Mobile Completo cm. 60	1	Arrivo	Arrivo
EIRENE80APP3CSI	Mobile Completo cm. 80	1	434,46 €	460,52 €
EIRENE100APP3CSI	Mobile Completo cm. 100	1	511,56 €	542,25 €

Sigla Disponibilità colori

- BT Bianco Titanio
- BE Bengala
- CE Cemento
- DV Dolce Vita
- OS Ossido
- SH Sherwood
- SI Signal

Mobile Eirene con 2 cassetti sospeso Completo di lavabo e specchio reversibile senza lead



Codice	Riferimenti	Off.	Listino A	Listino B
EIRENE60SI	Mobile Completo cm. 60	1	321,33 €	340,61 €
EIRENE80SI	Mobile Completo cm. 80	1	372,74 €	395,11 €
EIRENE100SI	Mobile Completo cm. 100	1	411,30 €	435,98 €

Sigla Disponibilità colori

- BT Bianco Titanio
- BE Bengala
- CE Cemento
- DV Dolce Vita
- OS Ossido
- SH Sherwood
- SI Signal

Mobile Eirene con 3 cassetti e piedini Completo di lavabo e specchio reversibile senza led



Codice	Riferimenti	Off.	Listino A	Listino B
EIRENE60APP3CSI	Mobile Completo cm. 60	1	Arrivo	Arrivo
EIRENE80APP3CSI	Mobile Completo cm. 80	1	434,46 €	460,52 €
EIRENE100APP3CSI	Mobile Completo cm. 100	1	511,56 €	542,25 €

Sigla Disponibilità colori

BT	Bianco Titanio
BE	Bengala
CE	Cemento
DV	Dolce Vita
OS	Ossido
SH	Sherwood
SI	Signal

Mobile Eirene con 2 cassetti sospeso Completo di lavabo e specchio reversibile senza led



Codice	Riferimenti	Off.	Listino A	Listino B
COLDREAMSI	Signal	1	110,55 €	117,18 €
COLDREAMBT	Bianco Titanio	1	110,55 €	117,18 €
COLDREAMBE	Bengala	1	110,55 €	117,18 €
COLDREAMDV	Dolce Vita	1	110,55 €	117,18 €
COLDREAMOS	Ossido	1	110,55 €	117,18 €
COLDREAMSH	Sherwood	1	110,55 €	117,18 €

Sigla Disponibilità colori



Bengala



Bianco Signal



Cemento



Ossido



Dolce Vital



Sherwood



Cubo Dream H. 45 Largo 45 Profondo 15

Cubo Dream con Anta apertura Push

Signal

Codice	Riferimenti	Off.	Listino A	Listino B
CUBOSI	Signal	1	63,01 €	66,79 €
CUBOBT	Bianco Titanio	1	63,01 €	66,79 €
CUBOBE	Bengala	1	63,01 €	66,79 €
CUBODV	Dolce Vita	1	63,01 €	66,79 €
CUBOOS	Ossido	1	63,01 €	66,79 €
CUBOSH	Sherwood	1	63,01 €	66,79 €



larghezza sportello cm. 17,5 Altezza Specchio cm. 57, Larghezza dello specchio cm. 80, Profondità cm. 14, Due Luci a led

Specchio da bagno con 2 ante

Codice	Riferimenti	Off.	Listino A	Listino B
SMILE80SI	Signal	1	135,83 €	143,98 €
SMILE80BT	Bianco Titanio	1	135,83 €	143,98 €
SMILE80BE	Bengala	1	135,83 €	143,98 €
SMILE80DV	Dolce Vita	1	135,83 €	143,98 €
SMILE80OS	Ossido	1	135,83 €	143,98 €
SMILE80SH	Sherwood	1	135,83 €	143,98 €



larghezza sportello cm. 17,5 Altezza Specchio cm. 57, Larghezza dello specchio cm. 60, Profondità cm. 14, Due Luci a led

Specchio da bagno con 1 anta

Codice	Riferimenti	Off.	Listino A	Listino B
JOY60SI	Signal	1	118,85 €	125,99 €
JOY60BT	Bianco Titanio	1	118,85 €	125,99 €
JOY60BE	Bengala	1	118,85 €	125,99 €
JOY60DV	Dolce Vita	1	118,85 €	125,99 €
JOY60OS	Ossido	1	118,85 €	125,99 €
JOY60SH	Sherwood	1	118,85 €	125,99 €



11) Colonna Dream Aperta 2 Ripiani H.
112 x L. 33 x P. 30

Codice	Riferimenti	Listino A	Listino B	Conf.	Box
CDA2RSI	Signal	120,39 €	127,62 €	1	1

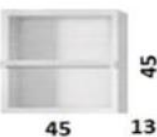

4M) Cubo Dream Aperto Con Mensola H.
45 x L. 45 x P. 13

Codice	Riferimenti	Listino A	Listino B	Conf.	Box
CAD1MSI	Signal	64,83 €	68,72 €	1	1



1) Colonna Sospesa Slim con Apertura
Push H. 80 x L. 25 x P. 20
Reversibile

Codice	Riferimenti	Listino A	Listino B	Conf.	Box
CSSP80SI	Signal	126,57 €	134,16 €	1	1



2) Mezza Colonna Slim CM. 60 Apertura
Dx H. 60 x L. 30 x P. 20
Su Richiesta Sx

Codice	Riferimenti	Listino A	Listino B	Conf.	Box
CSSP60DXSI	Signal	123,48 €	130,89 €	1	1



8) Mezza Colonna Slim CM. 60 Apertura
Dx
Su Richiesta Sx

Codice	Riferimenti	Listino A	Listino B	Conf.	Box
CSP60DXSI	Signal	117,31 €	124,34 €	1	1

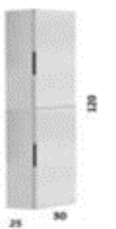

6) Colonna Dream Sospesa 2 Ante
Reversibile H. 130 x L. 30 x P. 25

Codice	Riferimenti	Listino A	Listino B	Conf.	Box
CD2ARSI	Signal	142,00 €	150,52 €	1	1

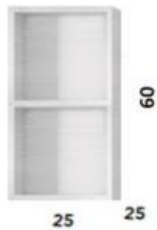

5) Colonna Dream Aperta Con Mensola

Codice	Riferimenti	Listino A	Listino B	Conf.	Box
CDA1RSI	Signal	117,31 €	124,34 €	1	1



4) Cubo Dream Aperto
H. 45 x L. 45 x P. 13

Codice	Riferimenti	Listino A	Listino B	Conf.	Box
CADSI	Signal	61,74 €	65,44 €	1	1

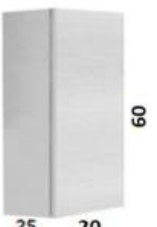

3) Colonna Sospesa Slim con Apertura
Push
Reversibile

Codice	Riferimenti	Listino A	Listino B	Conf.	Box
CSSP60DXSI	Signal	123,48 €	130,89 €	1	1



7) Colonna Dream Sospesa CM. 56 1 Anta
H. 56 x L. 35 x P. 30

Codice	Riferimenti	Listino A	Listino B	Conf.	Box
CSSP56SI	Signal	123,48 €	130,89 €	1	1



9) Base Multiuso con Cassetto più
Sportello

Codice	Riferimenti	Listino A	Listino B	Conf.	Box
BMC56SI	Signal	135,83 €	143,98 €	1	1



10) Colonna con piedini Multiuso 2
Sportelli
+ Cassetto

Codice	Riferimenti	Listino A	Listino B	Conf.	Box
CD2A1C168SI	Signal	237,70 €	251,96 €	1	1



Modello Sigma- Specchio Argentato
Senza Rame da 5
mm - Sensore Touch per Accensione-
Struttura in
Alluminio-Luce 6000 K-230V / 50 hz



Modello Paint- Specchio Argentato
Senza Rame da 5
mm - Sensore Touch per Accensione-
Struttura in
Alluminio-Luce 6000 K-230V / 50 hz

Codice	Riferimenti	Listino A	Listino B	Conf.	Box
SIGMA60	cm. 60	156,88 €	166,29 €	1	1
SIGMA70	cm. 70	156,88 €	166,29 €	1	1
SIGMA80	cm. 80	219,18 €	232,33 €	1	1

Codice	Riferimenti	Listino A	Listino B	Conf.	Box
PAINT6080	cm. 60x80	192,94 €	204,52 €	1	1
PAINT70100	cm. 70x100	221,34 €	234,62 €	1	1



Modello Delta- Specchio Argentato
Senza Rame da 5
mm - Sensore Touch per Accensione-
Struttura in
Alluminio-Luce 6000 K-230V / 50 hz

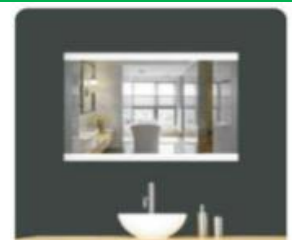

Modello Omega- Specchio Argentato
Senza Rame da 5
mm - Sensore Touch per Accensione-
Struttura in
Alluminio-Luce 6000 K-230V / 50 hz

Codice	Riferimenti	Listino A	Listino B	Conf.	Box
DELTA6080	cm. 60x80	201,59 €	213,68 €	1	1
DELTA70100	cm. 70x100	245,42 €	260,15 €	1	1

Codice	Riferimenti	Listino A	Listino B	Conf.	Box
OMEGA6080	cm. 60x80	206,21 €	218,58 €	1	1
OMEGA70100	cm. 70x100	236,16 €	250,33 €	1	1

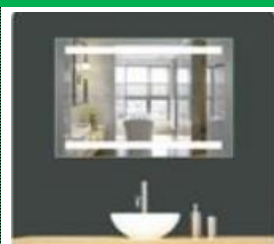

Modello Beta- Specchio Argentato
Senza Rame
da 5 mm - Sensore Touch per
AccensioneStruttura in Alluminio-
Luce 6000 K-230V / 50 hz



Modello Alfa- Specchio Argentato
Senza Rame
da 5 mm - Sensore Touch per
AccensioneStruttura in Alluminio-
Luce 6000 K-230V / 50 hz

Codice	Riferimenti	Listino A	Listino B	Conf.	Box
BETA6080	cm. 60x80	210,23 €	222,84 €	1	1
BETA70100	cm. 70x100	240,79 €	255,23 €	1	1

Codice	Riferimenti	Listino A	Listino B	Conf.	Box
ALFA6080	cm. 60x80	215,79 €	228,73 €	1	1
ALFA70100	cm. 70x100	245,42 €	260,15 €	1	1

Mensola sospesa per lavabo bagno da appoggio, spessore 45 e profondita' 50 larghezza 60/80/110/140, serie Master con rivestimento idrorepellente (Possiamo realizzare la Mensola anche su misura) (prezzo solo per la mensola, non sono inclusi fissaggi ne ferramenta)

Codice	Riferimenti	Listino A	Listino B	Conf.	Box
MENSOLA60BI	60X50X45	83,35 €	88,35 €	1	1
MENSOLA80BI	80X50X45	111,13 €	117,80 €	1	1
MENSOLA100BI	100X50X45	138,91 €	147,25 €	1	1
MENSOLA110BI	110X50X45	149,72 €	158,71 €	1	1
MENSOLA120BI	120X50X45	166,70 €	176,70 €	1	1
MENSOLA140BI	140X50X45	194,48 €	206,15 €	1	1



Lavabo Appoggio

FLORIDIA NERO



FLORIDIA
500X390X135



NEVADA
480X370X130



VIRGINIA
455X325X135



Codice	Riferimenti	Listino A	Listino B	Conf.	Box
NEVADA	8053687660052	83,35 €	88,35 €	1	1
FLORIDIA NERO	8053687660038	182,13 €	193,06 €	1	1
FLORIDIA	8053687660021	108,04 €	114,53 €	1	1
VIRGINIA	8053687660069	77,18 €	81,81 €	1	1
ALASKA	8053687660007	83,35 €	88,35 €	1	1
ARIZONA	8053687660014	108,05 €	114,53 €	1	1
TEXAS	8053687660045	92,61 €	98,17 €	1	1

ALASKA
355X355X125



TEXAS
440X440X140



ARIZONA
520X395X130





Lavatoio 80X50 Basic Con Piedini E Strofinatoio In Legno BB85

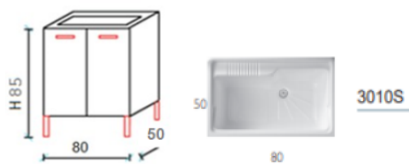

Codice	Riferimenti	Off.	Listino A	Listino B
BB85	Mobile Completo	1	206,80 €	229,55 €
3010S	Vasca Ricambio	1	92,95 €	103,17 €



Lavatoio 60X60 Basic Con Piedini E Strofinatoio In Legno BB66

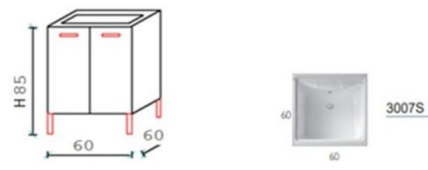

Codice	Riferimenti	Off.	Listino A	Listino B
BB66	Mobile Completo	1	133,96 €	148,69 €
3007S	Vasca Ricambio	1	34,85 €	38,69 €



Lavatoio 50X50 Basic Con Piedini E Strofinatoio In Legno BB55

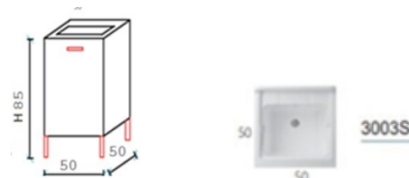

Codice	Riferimenti	Off.	Listino A	Listino B
BB55	Mobile Completo	1	128,73 €	142,89 €
3003S	Vasca Ricambio	1	34,85 €	38,69 €



Lavatoio 60X50 Basic Con Piedini E Strofinatoio In Legno BB65

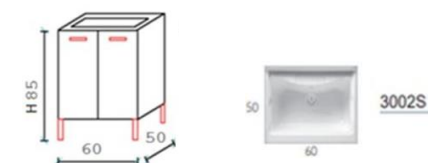

Codice	Riferimenti	Off.	Listino A	Listino B
BB65	Mobile Completo	1	131,36 €	145,80 €
3002S	Vasca Ricambio	1	34,85 €	38,69 €



Lavatoio 45X50 Basic Con Piedini E Strofinatoio In Legno BB54

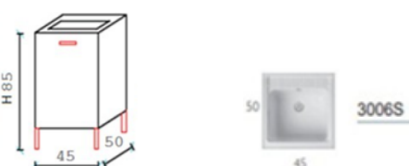

Codice	Riferimenti	Off.	Listino A	Listino B
BB54	Mobile Completo	1	127,68 €	141,73 €
3006S	Vasca Ricambio	1	34,85 €	38,69 €



Lavatoio 45X60 Basic Con Piedini E Strofinatoio In Legno BB64

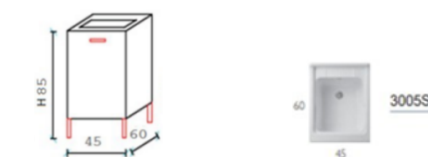

Codice	Riferimenti	Off.	Listino A	Listino B
BB64	Mobile Completo	1	164,51 €	182,61 €
3005S	Vasca Ricambio	1	69,71 €	77,38 €

Coprilavatrice



Codice	Linea Coprilavatrice	Riferimenti	Pz	Listino A	Listino B
CL64D	Lav. Dx	60X109XH90	1	229,88 €	255,16 €
CL64S	Lav. Sx	60X109XH90	1	229,88 €	255,16 €
CL66D	Lav. Dx	60X109XH90	1	243,98 €	270,82 €
CL66S	Lav. Sx	60X109XH90	1	243,98 €	270,82 €



Mobile Portalavatrice, in nobilitato classe E1 da 1,8 bordo colle poliuretaniche, vasca ABS completo di sifone.

TUTTI I MOBILI SONO REALIZZATI IN NOBILITATO SP.18MM.
 - VASCHE IN GRANITO RESISTENTI AGLI ACIDI, DUREVOLI NEL TEMPO.

LAVATOIO



Codice	Riferimenti	Pz	Listino A	Listino B
EL70	70-50 H83	1	386,72 €	429,26 €
EL60	60-50 H83	1	365,95 €	406,20 €
EL50	50-50 H83	1	359,42 €	398,95 €

Mobile completo di vasca in granito
 colori a scelta

COLORI VASCHE GRANITO DISPONIBILI



BIANCO



SAND



NERO BRILLANTATO

FINITURE DEI MOBILI DISPONIBILI



BIANCO LUCIDO



ROVER SBIANCATO



FRASSINO MOIORE



ROVER WELL

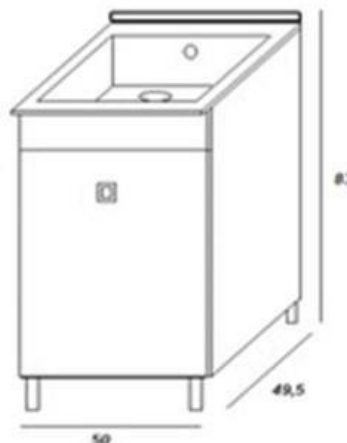
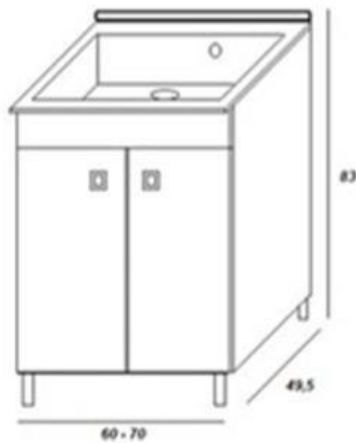



Lavatoio Pvc
C/Sport. 45X50
9006K



Esterni



Codice	Riferimenti	Off.	Listino A	Listino B
9006K		1	99,74 €	110,71 €

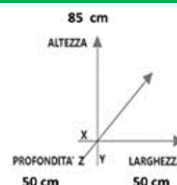

Lavatoio Pvc
C/Sport. 50X50
9003K



Esterni



Codice	Riferimenti	Off.	Listino A	Listino B
9003K		1	99,74 €	110,71 €

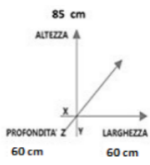

Lavatoio Pvc
C/Sport. 60X60
9007K



Esterni



Codice	Riferimenti	Off.	Listino A	Listino B
9007K		1	124,67 €	138,39 €

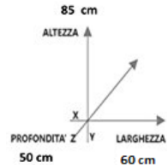

Lavatoio Pvc
C/Sport. 60X50
9002K



Esterni



Codice	Riferimenti	Off.	Listino A	Listino B
9002K		1	112,21 €	124,55 €



Sottolavelli Con Cassetti 120X50
Bianco Cassettiera Sx Lavello Inox
120 CL120CBSX



Codice	Riferimenti	Off.	Listino A	Listino B
CL120CBSX	CM. 120 Gocciolatoio SX	1	257,23 €	285,52 €



Sottolavelli Con Cassetti 120X50
Bianco Cassettiera Dx Lavello Inox
120 CL120CBDX



Codice	Riferimenti	Off.	Listino A	Listino B
CL120CBDX	CM. 120 Gocciolatoio DX	1	257,23 €	285,52 €



Sottolavelli Con Cassetti 120X50
Teck Cassettiera Dx Lavello Inox 120
CL120CTDX



Codice	Riferimenti	Off.	Listino A	Listino B
CL120CTDX	CM. 120 Gocciolatoio DX	1	257,23 €	285,52 €



Sottolavelli Con Cassetti 120X50
Teck Cassettiera Sx Lavello Inox 120
CL120CTSX



Codice	Riferimenti	Off.	Listino A	Listino B
CL120CTSX	CM. 120 Gocciolatoio SX	1	257,23 €	285,52 €



Kit Sottolavello 80X50 Teck Con
Cassetti Sx Lavello Inox 80X50 1
Vasche Piu' G. Sx
Bt5Ls+Pi801Lpc CL80CTLS

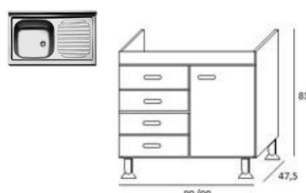

Codice	Riferimenti	Off.	Listino A	Listino B
CL80CTLS	CM. 80 Gocciolatoio SX	1	220,04 €	244,25 €
CL80CTLD	CM. 80 Gocciolatoio DX	1	220,04 €	244,25 €



Kit Sottolavello 80X50 Bianco Con
Cassetti Sx Lavello Inox 80X50 1
Vasche Piu' G. Sx
Bb5Ls+Pi801Lpc CL80CBLS

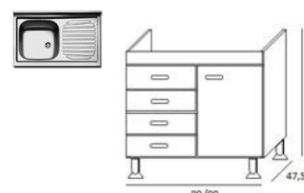

Codice	Riferimenti	Off.	Listino A	Listino B
CL80CBLS	CM. 80 Gocciolatoio SX	1	220,04 €	244,25 €
CL80CBLD	CM. 80 Gocciolatoio DX	1	220,04 €	244,25 €



Sottolavelli 80X50 Bianco
Lavello Inox 80X50 1
Vasche Piu' G. Dx
CL80BDX



Codice	Riferimenti	Off.	Listino A	Listino B
CL80BDX		1	186,08 €	206,55 €



Sottolavelli 80X50 Teck
Lavello Inox 80X50 1
Vasche Piu' G. Dx
CL80TDX



Codice	Riferimenti	Off.	Listino A	Listino B
CL80TDX		1	186,08 €	206,55 €



Sottolavelli 120X50
Bianco Dx Lavello Inox
120 X50 CL120BDX



Codice	Riferimenti	Off.	Listino A	Listino B
CL120BDX		1	238,64 €	264,89 €



Sottolavelli 120X50 Teck
Dx Lavello Inox 120 X50
CL120TDX



Codice	Riferimenti	Off.	Listino A	Listino B
CL120TDX		1	238,64 €	264,89 €



Lavello Appoggio 120X50cm
Destra Serie Pisa Prelucido
PI120RPC

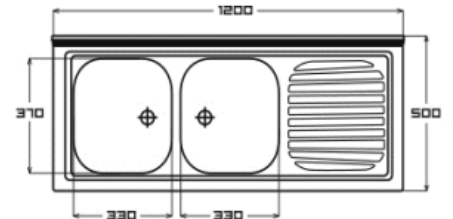

Codice	Codice Apell	Pz	Box	Riferimenti	Listino A	Listino B
PI120RPC	3740001C5	1	5	50cm prelucido	117,34 €	130,25 €
PI120LPC	3740201C5	1	5	50cm prelucido	117,34 €	130,25 €



Lavello 80X50 1 Vasca Piu
Gocciolatoio Destra - Serie Pisa
Prelucido PI801RPC

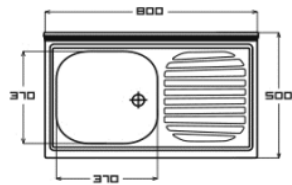

Codice	Riferimenti	Off.	Listino A	Listino B
PI801RPC	3710001C5	5	89,46 €	99,30 €
PI801LPC	3710201C5	5	89,46 €	99,30 €



Lavello Appoggio 80X50 Cm 2
Vasche - Serie Pisa Prelucido
PI802PC

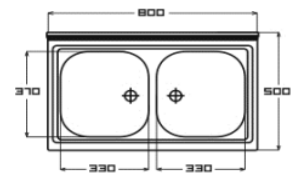

Codice	Riferimenti	Off.	Listino A	Listino B
PI802PC	3750001C5	5	103,40 €	114,78 €



Lavello Inox 86X50 Sx
AI86501GSSX

ht. 19 hv. 17

Altezza Vasca HV 17 Altezza totale HT 19
lavello Mod. Sole

Codice	Riferimenti	Off.	Listino A	Listino B
AI86501GSSX		1	63,25 €	70,21 €



Lavello Inox 86X50 Dx
AI86501GSDX

ht. 19 hv. 17

Altezza Vasca HV 17 Altezza totale HT 19
lavello Mod. Sole

Codice	Riferimenti	Off.	Listino A	Listino B
AI86501GSDX		1	63,26 €	70,22 €

KIT 4 PZ BOMPANI-APELL: LAVELLO CRITERIA COMPLETO DI ACCESSORI + FORNO 8 F PIANO DA 75 G. GHISA+MIX CANNA ALTA ELLECCI



Gamma Completa

Codice	CRT860IKIT	Codice	BO243OH/E	Codice	BO293MF/N	Codice	MIKC01CR
Codice	Riferimenti	Listino A	Listino B	Codice	Listino A	Listino B	
CRT860IKIT	Lavello Criteria 900 Con Kit Colatoio- Tagliere- Dos.Sapone- Acciaio Inox Spazzolato CRT860IKIT	292,78 €	324,98 €	K4BF8P75MEC	1231,19 €	1366,62 €	
BO243OH/E	Forno Vetro Oscurato E Acciaio Combinato 8 Funzioni BO243OH/E	480,18 €	533,00 €	KIT 4 PZ BOMPANI-APELL: LAVELLO CRITERIA COMPLETO DI ACCESSORI + FORNO 8 F PIANO DA 75 G. GHISA+MIX CANNA ALTA ELLECCI			
BO293MF/N	Piano 75 Bo 1 5Fv(Tc)Ac5 Inox Front 2007 BO293MF/N	362,21 €	402,05 €				
MIKC01CR	Mix Ellecci C01 Chrome MIKC01CR	89,82 €	99,70 €				

KIT 4 PZ BOMPANI-SOLE: LAVELLO SOLE + FORNO 6 F. PIANO DA 60 FRONTALE +MI Miscelatore Canna Alta



Gamma Completa

Codice	Al86501GSSX	Codice	33703089	Codice	33802764	Codice	MLMDE00
Codice	Riferimenti	Listino A	Listino B	Codice	Listino A	Listino B	
Al86501GSSX	Lavello Inox 86X50 Sx Al86501GSSX	63,25 €	70,21 €	K4S86BF6P60MCA	508,01 €	563,89 €	
33703089	Forno Pop Evo Elettrico, Convection + Fan, 65	255,25 €	283,33 €	KIT 4 PZ BOMPANI-SOLE: LAVELLO SOLE + FORNO 6 F. PIANO DA 60 FRONTALE +MI Miscelatore Canna Alta			
33802764	Piano Cottura Gas Su Metallo	155,74 €	172,87 €				
MLMDE00	Mix Debora Lav. Mon. C /Bassa MLMDE00	29,74 €	33,01 €				

KIT 4 PZ : LAVELLO Avena 116 + FORNO 6 F. PIANO DA 60 FRONTALE +MI Miscelatore Canna Alta Avena



Gamma Completa

Codice	PTPL1162GO	Codice	FCC604NAV	Codice	CHW6BRAV4WGT	Codice	MGKC0151
Codice	Riferimenti	Listino A	Listino B	Codice	Listino A	Listino B	
PTPL1162GO	Lavello 50.116 2V+G Gran.Avena PTPL1162GO	176,60 €	196,02 €	K4BF8P75ACE	913,00 €	1013,43 €	
FCC604NAV	Fcc604Nav Forno Elettrico Da Incasso Ventilato	388,09 €	430,78 €	KIT 4 PZ : LAVELLO Avena 116 + FORNO 6 F. PIANO DA 60 FRONTALE +MI Miscelatore Canna Alta Avena			
CHW6BRAV4WGT	Piano Da 60Cm Avena; Griglie In Piattina; 4	243,66 €	270,46 €				
MGKC0151	Mix Ellecci C01 Avena 51 MGKC0151	92,35 €	102,51 €				

KIT 4 PZ SCHOCK-ELLECCI: LAVELLO MASTER + FORNO 5 F. PIANO DA 60 G. CANNA ALTA ELLECCI ESTRAIBILE



Gamma Completa

Codice	LGM50040	Codice	SFN54BKN	Codice	STS64BK	Codice	MGKC0240
Codice	Riferimenti	Listino A	Listino B	Codice	Listino A	Listino B	
LGM50040	Master 500 1160X500 2 Vasche Con Gocciolatoio 40 Nero LGM50040	250,95 €	278,56 €	K4SF5P60ECE	979,50 €	1087,24 €	
SFN54BKN	Forno Schock New England Multifunzione Cm. 60 -	453,11 €	502,95 €	KIT 4 PZ SCHOCK-ELLECCI: LAVELLO MASTER + FORNO 5 F. PIANO DA 60 G. CANNA ALTA ELLECCI ESTRAIBILE			
STS64BK	Piano Cottura Silver Pc 60 Black STS64BK	197,51 €	219,24 €				
MGKC0240	Miscelatore Cucina Con Doccetta Estraibile	118,92 €	132,00 €				



G68 Bianco Titano
cod. **LGF36068**

G62 Bianco Antico
cod. **LGF36062**

G61 Pietra Antica
cod. **LGF36061**

G59 Antracite
cod. **LGF36059**

G54 Nero
cod. **LGF36054**

G53 Terra
cod. **LGF36053**



G52 Bianco
cod. **LGF36052**

G51 Avena
cod. **LGF36051**

G40 Full Black
cod. **LGF36040**

Gamma Completa



Altri colori Richiedi il Prezzo

Master 500 1160X500 2 Vasche Con Gocciolatoio
51 Avena LGM50051



Master 400 860X500 Mm 1 Vasca C/Gocciolatoio
51 Avena LGM40051



Master 450 860X500 Mm 2 Vasche 51 Avena
LGM45051



Codice	Off.	Listino A	Listino B
LGM50051	GTK	250,95 €	278,56 €

Codice	Off.	Listino A	Listino B
LGM40051	1	232,36 €	257,92 €

Codice	Off.	Listino A	Listino B
LGM45051	1	237,01 €	263,08 €

Life 500 1160x500 Mm 2 Vasche C/Gocciolatoio 51
Avena LG250051



Living 400 860X500 Mm 1 Vasca C/Gocciolatoio 51
Avena LGL40051



Life 450 860x500 Mm 2 Vasche 51 Avena
LG245051



Codice	Off.	Listino A	Listino B
LG250051	GTK	232,36 €	257,92 €

Codice	Off.	Listino A	Listino B
LGL40051	1	193,57 €	214,86 €

Codice	Off.	Listino A	Listino B
LG245051	1	223,07 €	247,61 €

Fox 360 860X500 Mm 1 Vasca 51 Avena
LGF36051



Lavello Laterale Monocomando Avena "Zc"
MXB005003AV



Mix Elleci S01 Avena 51 MGKS0151



Codice	Off.	Listino A	Listino B
LGF36051	GTK	264,90 €	294,03 €

Codice	Off.	Listino A	Listino B
MXB005003AV	1	45,54 €	50,55 €

Codice	Off.	Listino A	Listino B
MGKS0151	1	92,35 €	102,51 €

Lavello Criteria 900 Con Kit Colatoio- Tagliere-
Dos.Sapone- Acciaio Inox Spazzolato CRT860IKIT



Vascone Criteria Acciaio Inox CR860I



Mix Elleci C01 Chrome MIKC01CR



Codice	Off.	Listino A	Listino B
CRT860IKIT	GTK	292,78 €	324,98 €

Codice	Off.	Listino A	Listino B
CR860I	1	293,94 €	326,27 €

Codice	Off.	Listino A	Listino B
MIKC01CR	1	89,82 €	99,70 €



Serie ANTARES

Nuovi modelli prodotti in Pvc atossico, igienici e pratici per la pulizia, predisposti di binario con sistema di scorrimento laterale e con chiusura magnetica e attrezzati con sistema di scorrimento a pannelli lamellari anticondensa. Semplice da montare.

MODELLI BOX DOCCIA IN PVC SERIE ANTARES

Ariel/Antares PVC shower box - Ariel/Antares PVC shower box



MODELLI BOX VASCA IN PVC SERIE ANTARES

Ariel/Antares PVC shower for bath - Ariel/Antares PVC shower box for bath



**BOX DOCCIA PVC
SERIE "ANTARES"
MOD. VERA**

Codice	Riferimenti	Off.	Listino A	Listino B
BOXW70	70X70X70	1	148,11 €	148,11 €
BOXW80	80X80X80	1	156,50 €	156,50 €
BOXW90	90X90X90	1	165,05 €	165,05 €



**BOX DOCCIA PVC
SERIE "ANTARES"
MOD. MARY**

Codice	Riferimenti	Off.	Listino A	Listino B
BOXQ70	70X70X70	1	120,23 €	120,23 €
BOXQ80	80X80X80	1	155,79 €	155,79 €
BOXQ90	90X90X90	1	181,55 €	181,55 €



**BOX DOCCIA PVC
SERIE "ANTARES"
MOD. ANTHONY**

Codice	Riferimenti	Off.	Listino A	Listino B
BOXU70	80 X 80	1	113,11 €	113,11 €
BOXU70	90 X 90	1	113,11 €	113,11 €
BOXU790	75 X 90	1	124,49 €	124,49 €
BOXU90	90 X 90	1	153,06 €	153,06 €
BOXU100	100 X 100	1	128,76 €	128,76 €

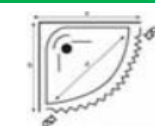

**BOX DOCCIA PVC
SERIE "ANTARES"
MOD. ANTHONY**

Codice	Riferimenti	Off.	Listino A	Listino B
BOXS80	80 X 80	1	140,14 €	140,14 €
BOXS90	90 X 90	1	147,97 €	147,97 €
BOXX80	80X80 ap. Centr.	1	206,59 €	206,59 €
BOXX90	90X90 ap. Centr.	1	217,86 €	217,86 €

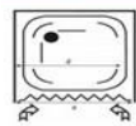

**BOX DOCCIA PVC
SERIE "ANTARES"
MOD. ELAN**

Codice	Riferimenti	Off.	Listino A	Listino B
BOXE70	70	1	68,29 €	68,29 €
BOXE80	80	1	72,56 €	72,56 €
BOXE90	90	1	77,54 €	77,54 €
BOXE100	100	1	95,79 €	95,79 €
BOXE120	120	1	106,28 €	106,28 €
BOXE140	140	1	118,03 €	118,03 €
BOXE150	150	1	172,15 €	172,15 €
BOXE170	170	1	155,68 €	155,68 €

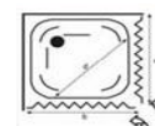

**BOX DOCCIA PVC
SERIE "ANTARES"
MOD. LILLY**

Codice	Riferimenti	Off.	Listino A	Listino B
BOXZ70	70 X 70	1	110,34 €	110,34 €
BOXZ80	80 X 80	1	106,35 €	106,35 €
BOXZ790	75 X 90	1	102,44 €	102,44 €
BOXZ90	90 X 90	1	108,09 €	108,09 €
BOXZ100	100 X 100	1	118,09 €	118,09 €
BOXZ8120	80 X 120	1	168,46 €	168,46 €
BOXZ8140	80 X 140	1	182,49 €	182,49 €

Parete Combinabili Single



Vetro Temperato D. 6 mm

Codice	Riferimenti	Off.	Listino A	Listino B
PBS700218	68<>70	h. 190	1	113,86 € 120,69 €
PBS800218	78<>80	h. 190	1	118,92 € 126,05 €
PBS900218	88<>90	h. 190	1	121,45 € 128,74 €
PBS1000218	98<>100	h. 190	1	123,98 € 131,42 €
PBS1200218	118<>120	h. 190	1	129,04 € 136,78 €
PBS1400218	138<>140	h. 190	1	136,63 € 144,83 €

Componi i lati secondo le tue necessità



Porta Strass
138<>142 Sc.Le Zx
Vetro Satinato Prof.
Cromo PS1400218

Codice	Riferimenti	Off.	Listino A	Listino B
PS1200218	118<>122	1	240,37 €	254,79 €
PS1400218	138<>142	1	250,49 €	265,52 €



Parete Fissa 73<>77
Prof. Cromo Vetro
Trasparente
PF750218

Codice	Riferimenti	Off.	Listino A	Listino B
PF700218	68<>72	1	197,66 €	209,52 €
PF750218	73<>77	1	201,15 €	213,22 €
PF800218	78<>82	1	210,41 €	223,04 €



Porta Doccia Strass 2
Ante 170 Vetro
Satinato Prof. Cromo
PS2A1700218

Codice	Riferimenti	Off.	Listino A	Listino B
PS2A1500218	148<>152	1	312,43 €	331,17 €
PS2A1600218	158<>162	1	325,18 €	344,69 €
PS2A1700218	168<>172	1	337,93 €	358,21 €
PS2A1800218	178<>182	1	364,35 €	386,21 €



Porta Doccia Strass 1
Anta 80 Vetro
Satinato Prof. Cromo
PS1A800218

Codice	Riferimenti	Off.	Listino A	Listino B
PS1A700218	68<>72	1	191,28 €	202,76 €
PS1A750218	73<>77	1	197,66 €	209,52 €
PS1A800218	78<>82	1	204,03 €	216,28 €
PS1A900218	88<>92	1	213,60 €	226,41 €

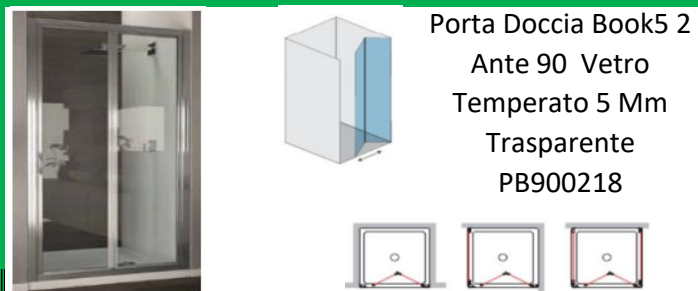

Porta Doccia Book5 2
Ante 90 Vetro
Temperato 5 Mm
Trasparente
PB900218

Codice	Riferimenti	Off.	Listino A	Listino B
PB700218	68<>72	1	255,04 €	270,35 €
PB750218	73<>77	1	258,23 €	273,72 €
PB800218	78<>82	1	264,61 €	280,48 €
PB900218	88<>92	1	270,98 €	287,24 €
PB1000218	98<>102	1	280,55 €	297,38 €

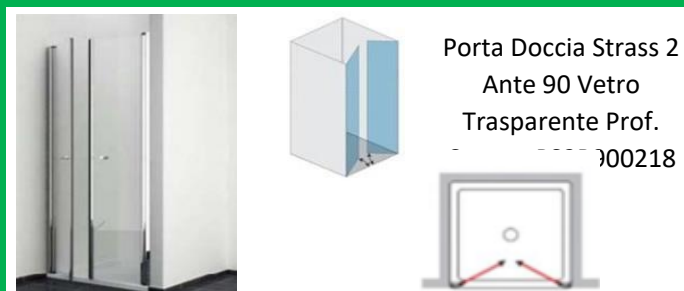

Porta Doccia Strass 2
Ante 90 Vetro
Trasparente Prof.
PS2B00218

Codice	Riferimenti	Off.	Listino A	Listino B
PS2B700218	70 cm	1	191,28 €	202,76 €
PS2B750218	75 cm	1	200,85 €	212,90 €
PS2B800218	80 cm	1	209,50 €	222,07 €
PS2B900218	90 cm	1	220,43 €	233,66 €
PS2B1000218	100 cm	1	229,54 €	243,31 €

Box Doccia a Soffietto praticità e semplicità ad un basso prezzo



PROFESSIONALITA' E QUALITA'



EVOKlima™

TECNOLOGIA - BENESSERE - RISPETTO PER L'AMBIENTE



Serie Civita

Cod. **VSPPB** Vaso Civita P 360x480x405 mm in Ceramica Bianco Lucido.

Cod. **VSPPB** Civita Glossy White Ceramic P/Trap WC Clost 360x480x405 mm.

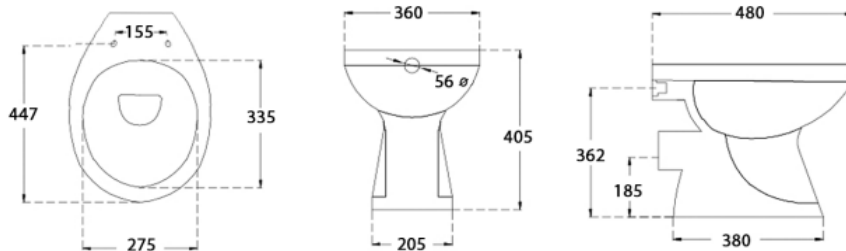

VASO CIVITA P.360X480X405 IN CERAMI CA BIANCO

SCARICO PARETE VSPPB

Codice	Offerta	Peso	Conf.	Box	Listino A	Listino B
VSPPB	1	1	1	24	50,60 €	53,64 €
VSPPBx24	24	24	1	24	45,54 €	48,28 €
SAT1750 Copriwater		1	1	24	34,08 €	34,08 €
SAT1750x24	24	24	1	24	27,89 €	27,89 €



Per bacale intero Pz 24 Extra 10%

Serie Civita

Cod. **VSTPB** Vaso Civita S 360x480x405 mm in Ceramica Bianco Lucido.

Cod. **VSTPB** Civita Glossy White Ceramic Monobloc S /Trap WC Closet 360x480x405 mm



Vaso Civita Scarico Terra 360x475x400 mm in Ceramica

Bianco Lucido VSTPB

Codice	Offerta	Peso	Conf.	Box	Listino A	Listino B
VSTPB	1	1	1	24	50,60 €	53,64 €
VSTPBx24	24	24	1	24	45,54 €	48,28 €
SAT1750 Copriwater		1	1	24	34,08 €	34,08 €
SAT1750x24	24	24	1	24	27,89 €	27,89 €



Per bacale intero Pz 24 Extra 10%

Serie Civita

Cod. **BUPB** Bidet Civita 3565x525x400 mm in Ceramica Bianco Lucido.

Cod. **BUPB** Civita Glossy White Ceramic Bidet 365x525x400 mm.

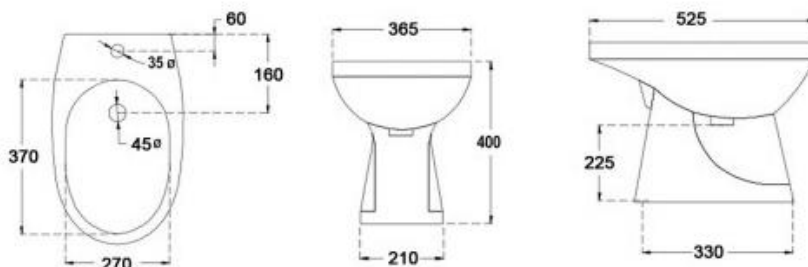

Bidet Civita 365x525x400 mm in Ceramica Bianco Lucido

BUPB

Codice	Offerta	Peso	Conf.	Box	Listino A	Listino B
BUPB	1	1	1	24	50,60 €	53,64 €
BUPBx24	24	24	1	24	45,54 €	48,28 €



Per bacale intero Pz 24 Extra 10%

Cod. **LUPB60** Lavabo Civita 605x455x178 mm in Ceramica Bianco Lucido.

Cod. **LUPB60** Civita Glossy White Ceramic Wash Basin 605x455x178 mm.

Serie Civita

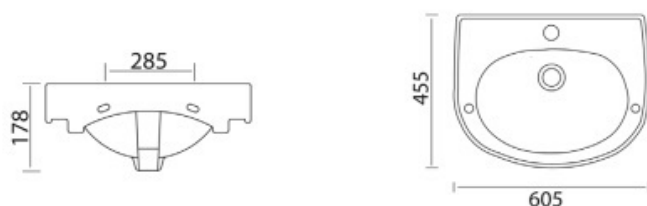

Lavabo Civita 605x460x175 mm in Ceramica Bianco Lucido

LUPB60

Codice	Offerta	Peso	Conf.	Box	Listino A	Listino B
LUPB60	1		1	24	50,60 €	53,64 €
LUPB60x24	24		1	24	45,54 €	48,28 €



Per bacale intero Pz 24 Extra 10%

Cod. **LUPB65** Lavabo Civita 650x555x230 mm in Ceramica Bianco Lucido.

Cod. **LUPB65** Civita Glossy White Ceramic Pedestal 650x553x190 mm.

Serie Civita

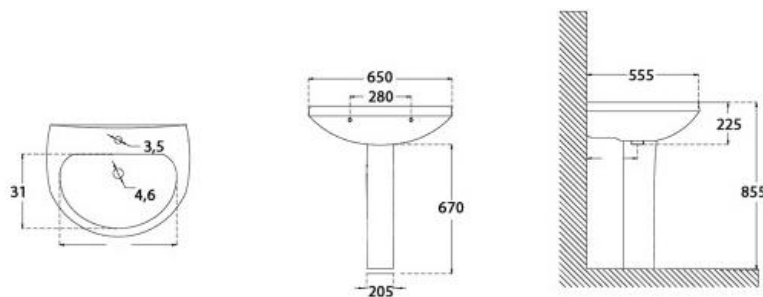

Lavabo Civita 650x552x190 mm in Ceramica Bianco Lucido

LUPB65

Codice	Offerta	Peso	Conf.	Box	Listino A	Listino B
LUPB65	1		1	24	50,60 €	53,64 €
LUPB65x24	24		1	24	45,54 €	48,28 €



Per bacale intero Pz 24 Extra 10%

Cod. **CLUPB** Colonna Civita 195x690 mm in Ceramica Bianco Lucido.

Cod. **CLUPB** Civita Glossy White Ceramic Pedestal 195x690 mm.

Serie Civita

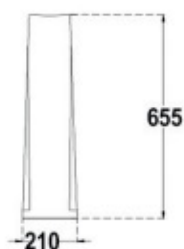

Colonna per lavabo in ceramica Bianca CLUPB

Codice	Offerta	Peso	Conf.	Box	Listino A	Listino B
CLUPB	1		1	24	50,60 €	53,64 €
CLUPBx24	24		1	24	45,54 €	48,28 €



Per bacale intero Pz 24 Extra 10%

Cod. **CAPB** Cassetta Alta Civita 440x250x325 mm in Ceramica Bianco Lucido.

Cod. **CAPB** Civita Glossy White Ceramic High Tank 440x250x325 mm

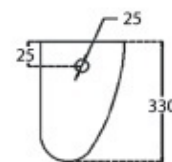
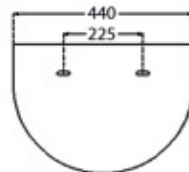
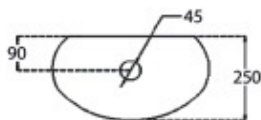

Cassetta Alta Civita 435x250x325 mm in Ceramica Bianco

Lucido CAPB

Codice	Offerta	Peso	Conf.	Box	Listino A	Listino B
CAPB	1		1	24	37,95 €	40,23 €
CAPBx24	24		1	24	34,16 €	36,21 €



Per bacale intero Pz 24 Extra 10%



Pila in Porcellana bianca 60X50X40 AS03

Codice	Offerta	Peso	Conf.	Box	Listino A	Listino B
AS03	1		1	24	126,51 €	134,10 €
AS03x24	24		1	24	113,86 €	120,69 €



Pila in Porcellana bianca
60X50X40



Per bacale intero Pz 24 Extra 10%



Buttatoio Kg.13 Cm. 42X38 AS01

Codice	Offerta	Peso	Conf.	Box	Listino A	Listino B
AS01	1		1	24	88,56 €	93,87 €
AS01x24	24		1	24	79,70 €	84,48 €



Buttatoio Kg.13 Cm.
42X38



Per bacale intero Pz 24 Extra 10%



Lavabo Corinto Cm 48X27 S/Foro AVB4

Codice	Riferimenti	Peso	Conf.	Box	Listino A	Listino B
AVB4			1	4	50,10 €	53,10 €



Lavabo Corinto Cm. 58X45 AVB6

Codice	Riferimenti	Peso	Conf.	Box	Listino A	Listino B
AVB6			1	4	50,10 €	53,10 €



Lavabo Corinto Cm 440x380x200 AVB3

Codice	Riferimenti	Peso	Conf.	Box	Listino A	Listino B
AVB3			1	4	50,10 €	53,11 €

Vaso & Bidet Azzurra Serie Cult



Vaso a pavimento cm 51 con scarico a parete; trasformabile a terra tramite curva tecnica in plastica
 Bidet a pavimento cm 51 con troppopieno
 kit di fissaggio verticale per vaso e bidet
 Coprivaso avvolgente in termoindurente bianco normale

AZZURRA
 riscopri la purezza



Tutti i sanitari AZZURRA in base alla normativa europea UNI EN 997:2007 per i vasi in CLASSE 2, effettuano uno scarico completo monoflusso con soli 3 litri d'acqua associandoli alle placche/ cassette di scarico AZZURRA.

CODICE	Descrizione	Riferimenti		Listino A	Listino B
CLZ100B4P	VASO SCARICO PARETE	51X36	XCU100P	102,02 €	108,14 €
CLZ500B4	BIDET	51X36	XCU500	102,02 €	108,14 €
SXCU100P	Sedile Frizionate	51X36	SXCU100P	51,36 €	54,44 €

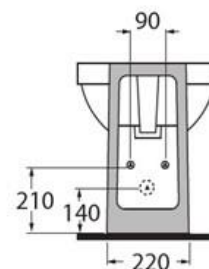
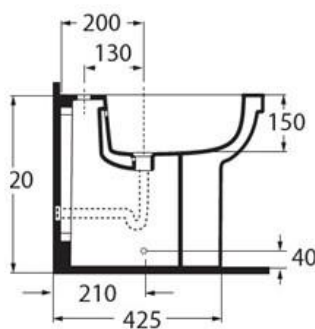
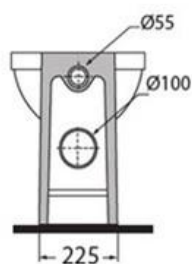
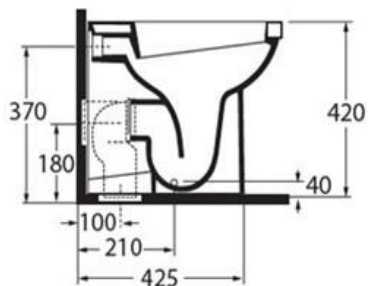
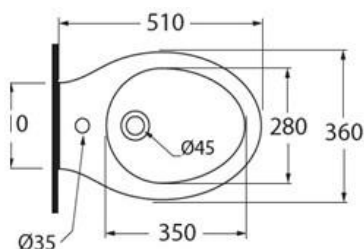
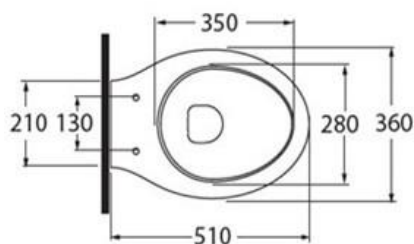

Vaso & Bidet Azzurra Serie Glaze



Sanitari CERAMICA **AZZURRA**

Vaso sospeso Azzurra serie Glaze in ceramica bianco
 Design con linee semplici ed essenziali dall'approccio sobrio che va oltre le mode e le tendenze passeggere
 Questo fa sì che dal momento in cui viene collocato nel bagno è come se i sanitari diventassero una estensione naturale dell'architettura degli ambienti in cui sono inseriti
 Scarico del wc brevettato con risparmio idrico a 3 litri
 Installazione e scarico a parete
 L'articolo comprende soltanto il vaso wc e il kit di fissaggio



CODICE	Descrizione	Riferimenti	Listino A	Listino B
GLZ100P	VASO PARETE	CM. 52	166,94 €	176,96 €
GLZ500B4	BIDET	CM. 52	166,93 €	176,94 €
	Copriwater Soft	CM. 52	Arrivo	Arrivo

AZZURRA
 riscopri la purezza

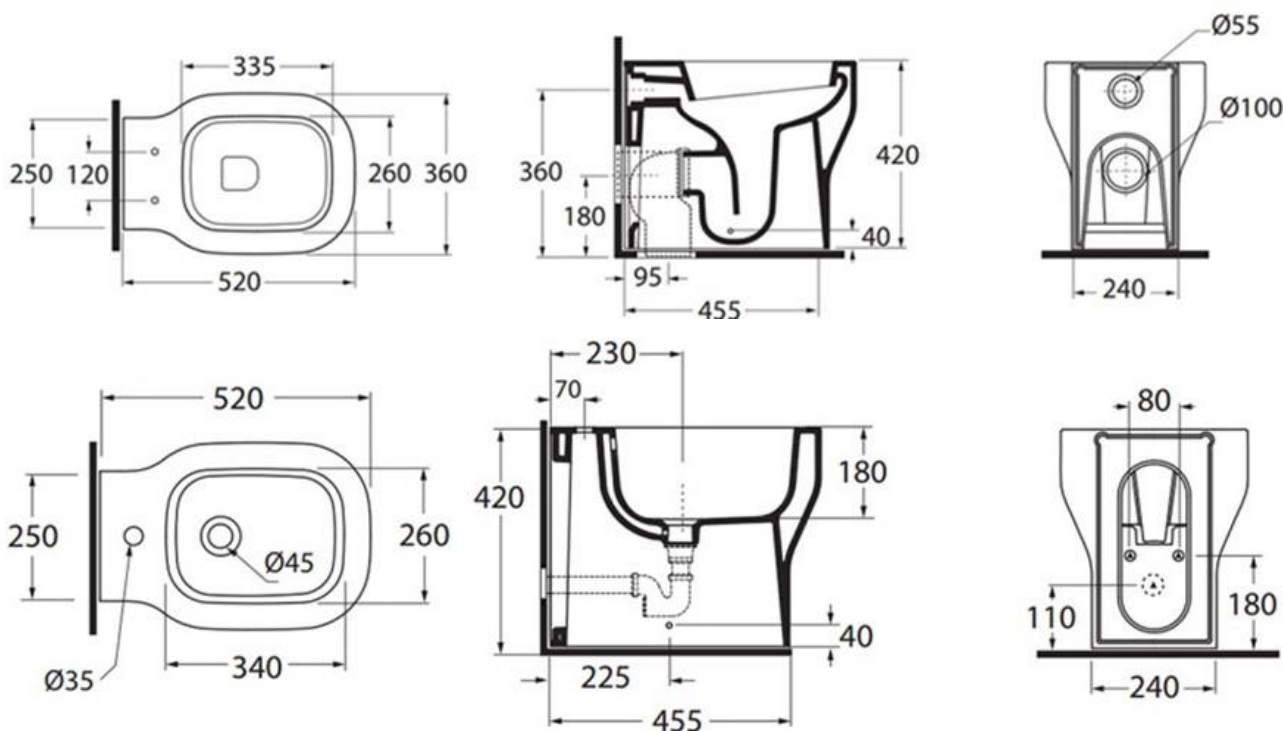

Vaso & Bidet Azzurra Serie FAST



Officina **Azzurra**: La serie si ispira ai concetti contemporanei di praticità, funzionalità, adattabilità. Si propone come una collezione snella, formata da vaso e bidet da terra, più una soluzione lavabo declinabile sia nella dinamica versione sospesa che nella più classica variante su colonna. Il design gioca con linee ergonomiche e arrotondate che promettono comfort attraverso le forme compatte.

Vaso con scarico a parete trasformabile a terra tramite curva tecnica in plastica

Dimensioni/dimensions: 51,5 X 36,5 X 42 cm
Peso/weight: 22 kg

Bidet monoforo

Dimensioni/dimensions: 55x35xH 42 cm
Peso/weight: 24 kg

CODICE	Descrizione	Riferimenti	Listino A	Listino B
FAVCTP	Vaso terra filomuro	51,5x31xh42 cm	97,59 €	103,44 €
FABITM	Bidet terra monoforo	51,5x31xh42 cm	97,59 €	103,44 €

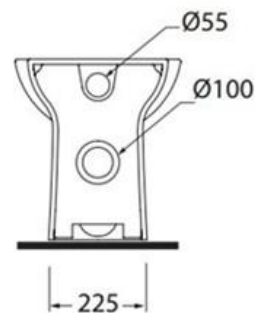
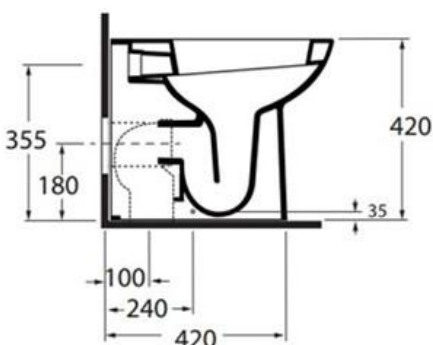
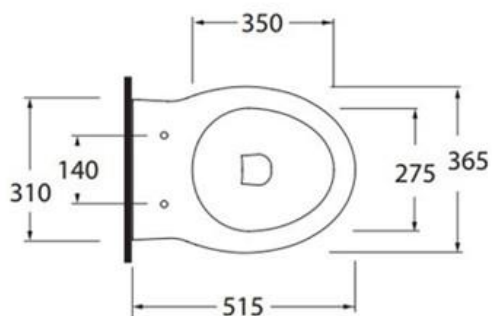
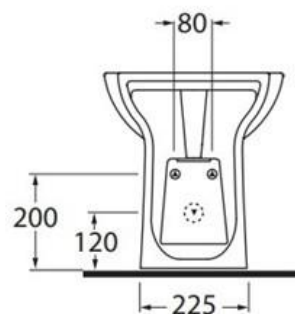
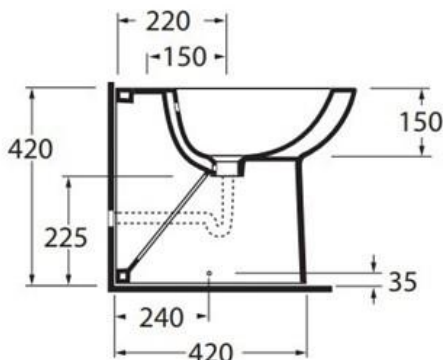
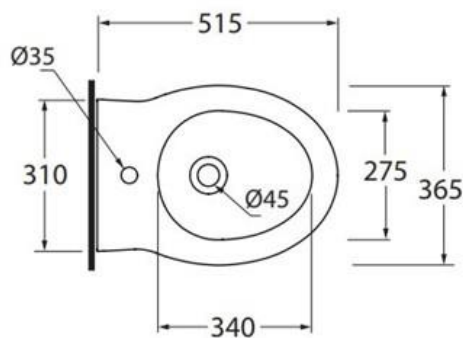



Vaso & Bidet Azzurra Serie JUBILELAEUM

Vaso e Bidet Jubilaeum Azzurra



DESIGNER:

Si ispira al passato la serie che l'architetto Marisa Grifone ha dedicato agli ambienti bagno di gusto classico. Le linee intramontabili e le proporzioni confortevoli si integrano perfettamente con le caratteristiche dei sanitari di nuova generazione e con le innovative dotazioni tecnologiche Azzurra.

CODICE	Descrizione	Riferimenti	Listino A	Listino B
JUVCTP000000	VASO TERRA FILOMURO	56x39xh42 cm	202,42 €	214,56 €
JUBITOB0000M	BIDET FILOMURO	56x39xh42 cm	202,42 €	214,56 €

Lavabi Azzurra Serie JUBILELAEUM

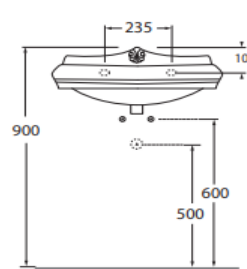
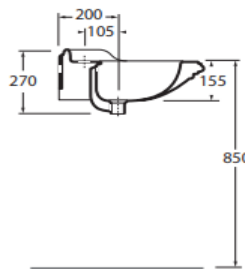
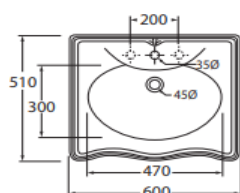

06051T0M

CODICE	Descrizione	Riferimenti	Listino A	Listino B
06051T0M	Lavabo 60 cm monoforo	60x51xh27 cm	Lavabo Appoggio	Arrivo

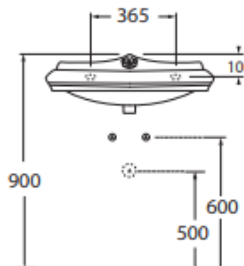
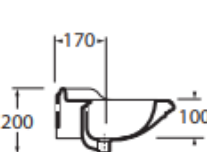
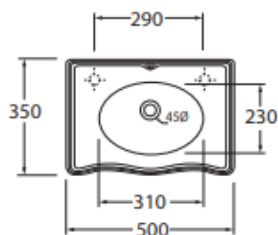

05035T0M

CODICE	Descrizione	Riferimenti	Listino A	Listino B
05035T0M	Lavabo 50 cm	50x35xh20 cm	Lavabo Sospeso	Arrivo

Serie Oggi

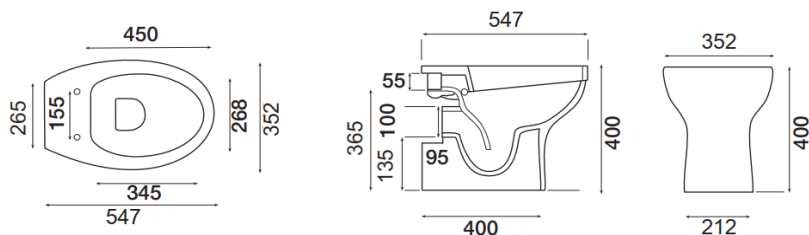

Cod. 1757.00 Vaso Oggi P 360x550x395 mm in Ceramica

Bianco Lucido. 1757.00

Codice	Riferimenti	Peso	Conf.	Box	Listino A	Listino B
1757.00	Offerta PZ 1		1	6	99,40 €	105,36 €
1757.00x2	Offerta PZ 2		1	6	88,56 €	93,88 €
1757.00x6	Offerta PZ 6		1	6	81,33 €	86,21 €

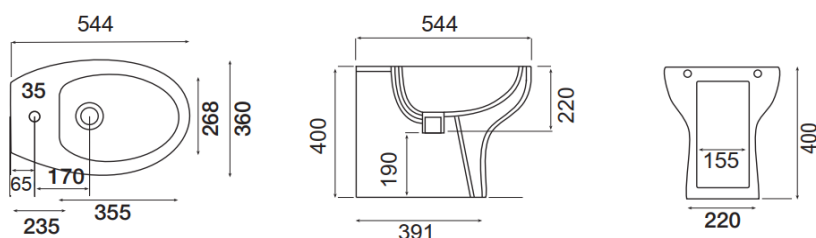

Bianco Lucido. 1758.00

Codice	Riferimenti	Peso	Conf.	Box	Listino A	Listino B
1758.00	Offerta PZ 1		1	6	99,40 €	105,36 €
1758.00x2	Offerta PZ 2		1	6	88,56 €	93,88 €
1758.00x6	Offerta PZ 6		1	6	81,33 €	86,21 €



Copriwater Civita/Oggi/Nepi Thermoplast Solt Close.

Codice	Riferimenti	Peso	Conf.	Box	Listino A	Listino B
SAT1757	Offerta PZ 1		1	6	45,55 €	50,56 €
SAT1757x2	Offerta PZ 2		1	6	45,55 €	45,55 €
SAT1757x6	Offerta PZ 6		1	6	41,83 €	41,83 €



Copriwater Oggi Bianco In PVC Soft Close Sgancio di Rilascio.

Codice	Riferimenti	Peso	Conf.	Box	Listino A	Listino B
SAT1750	Offerta PZ 1		1	6	34,08 €	34,08 €
SAT1750x5	Offerta PZ 2		1	6	30,36 €	30,36 €
SAT1750x24	Offerta PZ 6		1	6	27,89 €	27,89 €



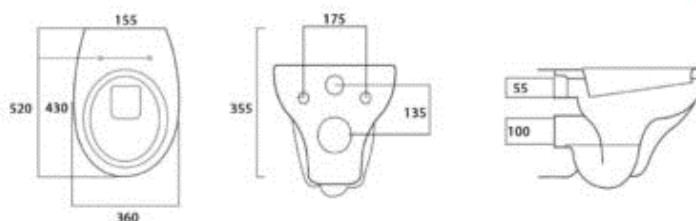

VASO NEPI SOSPEO P.360X510X365 IN CERAMICA BIANCO LUCIDO 1756.20

Codice	Offerta	Peso	Conf.	Box	Listino A	Listino B
1756.20			1	12	99,40 €	105,36 €
1756.20x4	4		1	12	81,33 €	86,21 €

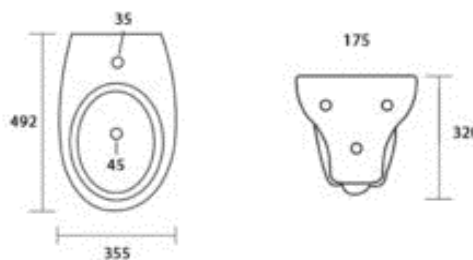

BIDET NEPI SOSPEO 360X500X340 IN CERAMICA BIANCO LUCIDO 1756.30

Codice	Offerta	Peso	Conf.	Box	Listino A	Listino B
1756.30			1	12	99,40 €	105,36 €
1756.30x4	4		1	12	81,33 €	86,21 €



Copriwater Civita/Oggi/Nepi Thermoplast Solt Close.

Codice	Riferimenti	Peso	Conf.	Box	Listino A	Listino B
SAT1757	Offerta PZ 1		1	6	45,55 €	50,56 €
SAT1757x2	Offerta PZ 2		1	6	45,55 €	45,55 €
SAT1757x6	Offerta PZ 6		1	6	41,83 €	41,83 €



Fissaggio Sanitari sospesi spugna



Fissaggio Sanitari sospeso universali

Codice	Riferimenti	Listino A	Listino B	Off.	Pz
FISSONE		7,92 €	8,79 €	1	1

Codice	Riferimenti	Listino A	Listino B	Off.	Pz
FISSOROL		8,59 €	9,54 €	1	1



Supporto Sanitari Sospesi Universale Bidet - Vaso SSSU

Codice	Riferimenti	Peso	Conf.	Box	Listino A	Listino B
SSSU	Offerta PZ 1		1	6	17,37 €	18,41 €
SSSUx2	Offerta PZ 2		1	6	16,68 €	17,69 €
SSSUx6	Offerta PZ 6		1	6	16,00 €	16,96 €



VASO EMY IN CERAMIC FILO MURO BIANCO LUCIDO

1759.00

Codice	Riferimenti	Peso	Conf.	Box	Listino A	Listino B
1759.00	Offerta PZ 1		1	6	127,80 €	127,80 €
1759.00x2	Offerta PZ 2		1	6	113,86 €	113,86 €
1759.00x6	Offerta PZ 6		1	6	104,57 €	104,57 €



BIDET EMY IN CERAMIC FILO MURO BIANCO LUCIDO

1760.00

Codice	Riferimenti	Peso	Conf.	Box	Listino A	Listino B
1760.00	Offerta PZ 1		1	6	127,80 €	127,80 €
1760.00x2	Offerta PZ 2		1	6	113,86 €	113,86 €
1760.00x6	Offerta PZ 6		1	6	104,57 €	104,57 €



Sedile Soft Close Sat PER SANITARUI EMY SATEMY

Codice	Riferimenti	Peso	Conf.	Box	Listino A	Listino B
SATEMY	Offerta PZ 1		1	5	70,85 €	78,64 €
SATEMYx2	Offerta PZ 2		1	5	67,96 €	67,96 €
SATEMYx5	Offerta PZ 5		1	5	65,07 €	72,22 €



Un mondo di idee per il tuo bagno

Arredare il bagno può diventare davvero una bella sfida. Noi non lasciamo nulla al caso, ecco perché troverai tutto ciò di cui hai bisogno in questa sezione.

Mobili da bagno di ogni dimensione, sia a terra che sospesi, i sanitari filomuro, sospesi o tradizionali. Tutta la rubinetteria, i lavabi, i box doccia e i piatti doccia, i termoarredi, gli specchi e tantissimi complementi.

Scegli il tuo stile e completa l'arredo dell'ambiente bagno: qui c'è veramente tutto.





Lavabo In Ceramica 395x395x190 1257.00

Codice	Offerta	Peso	Conf.	Box	Listino A	Listino B
1257.00	1		1	4	58,09 €	61,58 €
1257.00x4	4		1	4	51,64 €	54,74 €



Lavabo In Ceramica 420X320X160 1257.50

Codice	Offerta	Peso	Conf.	Box	Listino A	Listino B
1257.50	1		1	4	58,09 €	61,58 €
1257.50x4	4		1	4	51,64 €	54,74 €



Lavabo In Ceramica 640x400x120 1239.00

Codice	Offerta	Peso	Conf.	Box	Listino A	Listino B
1239.00	1		1	4	116,18 €	123,15 €
1239.00x4	4		1	4	103,28 €	109,48 €



Borchia copriforo sovrappieno lavabi

Codice	Offerta	Peso	Conf.	Box	Listino A	Listino B
BSC704	Cromo		1	4	1,01 €	1,07 €
BSD705	Dorata		1	4	2,81 €	2,98 €
BSN709	Nera		1	4	1,11 €	1,17 €



Lavabo In Ceramica 280x395x110 1255.28

Codice	Offerta	Peso	Conf.	Box	Listino A	Listino B
1255.28	1		1	4	69,71 €	73,89 €
1255.28x4	4		1	4	61,97 €	65,69 €



1770.48 Lavabo 480x320x140 In Ceramica Bianco Kg.9,00

Lavabo In Ceramica 480x320x140 1770.48

Codice	Offerta	Peso	Conf.	Box	Listino A	Listino B
1770.48	1		1	4	69,71 €	73,89 €
1770.48x4	4		1	4	61,97 €	65,69 €



1770.49 Lavabo 490x370x110 mm. In Ceramica Bianco Lucido Kg.9,5



Lavabo In Ceramica 490x375x110 1770.49

Codice	Offerta	Peso	Conf.	Box	Listino A	Listino B
1770.49	1		1	4	69,71 €	73,89 €
1770.49x4	4		1	4	61,97 €	65,69 €



1770.60 Lavabo 600x330x125 mm. In Ceramica Bianco Kg.12,00

Lavabo In Ceramica 600x330x125 1770.60

Codice	Offerta	Peso	Conf.	Box	Listino A	Listino B
1770.60	1	1	1	4	69,71 €	73,89 €
1770.60x4	4	4	1	4	61,97 €	65,69 €

Lavabo Sottopiano Largo 580 Profondo 360 " Zz" TATZAVW



Codice	Offerta	Peso	Conf.	Box	Listino A	Listino B
TATZAVW	1	1	1	4	99,16 €	99,16 €
TATZAVWx4	4	4	1	4	94,44 €	94,44 €

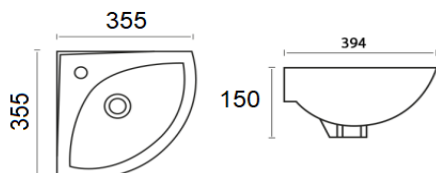

Lavabo Angolo M. Ceramica Bianco Lucido 1251.50



Codice	Offerta	Peso	Conf.	Box	Listino A	Listino B
1251.50	1	1	1	12	56,80 €	60,21 €
1251.50x4	4	4	1	12	46,48 €	49,26 €
1251.50x6	6	6	1	12	43,38 €	45,98 €
1251.50x12	12	12	1	12	41,31 €	43,79 €

Lavabo In Ceramica cm 600x465x140 1278.00

Codice	Offerta	Peso	Conf.	Box	Listino A	Listino B
1278.00	1	1	1	12	63,25 €	67,05 €
1278.00x4	4	4	1	12	58,09 €	61,58 €
1278.00x6	6	6	1	12	54,22 €	57,47 €
1278.00x12	12	12	1	12	51,64 €	54,74 €





COMUNITA' TERZA ETA'

Rubinetti a pedale & Bocche erogazione



Rubinetti a sensore



Rubinetti a leva clinica



Sanitari per Disabili



Sgabelli - Idroscopini



LAVELLO MISCELATORE / SINK MIXER



Miscelatore lavabo elettronico con canna girevole con alimentazione a batteria Electronic basin with swinging spout powered by battery Mitigeur lavabo électronique avec bec rotatif avec alimentation par batteries. Art. 7091SB 7091SB



Codice	Riferimenti	Listino A	Listino B	Off.	Box
7091SB	1	395,61 €	439,13 €	1	5
7091SBx5	5	378,77 €	420,44 €	1	5

LAVABO / BASIN TAP



Rubinetto miscelatore per lavabo, a comando elettronico ed alimentato a batterie.installazione sopra piano. Connessione tubo flessibile G 1/2"



Codice	Riferimenti	Listino A	Listino B	Off.	Box
703601	1	294,43 €	326,82 €	1	5
703601x5	5	281,90 €	312,91 €	1	5

PEDALE MONOACQUA / PEDAL SINGLE-WATER TAP



Rubinetto a pedale temporizzato a parete/pavimento Self-closing pedal wall-mounted/floor-mounted tap Robinet temporisé à pédale mural/au plancher. Art. 9056 9056



Codice	Riferimenti	Listino A	Listino B	Off.	Box
9056	1	93,83 €	104,15 €	1	5
9056x5	5	89,83 €	99,72 €	1	5

PEDALE MISCELATORE / PEDAL MIXER



Miscelatore a pedale temporizzato a parete/pavimento Self-closing pedal wall-mounted/floor-mounted mixer Mitigeur temporisé à pédale mural/au plancher. Art. 9010 9010



Codice	Riferimenti	Listino A	Listino B	Off.	Box
9010	1	160,13 €	177,75 €	1	5
9010x5	5	153,32 €	170,18 €	1	5

LAVABO / BASIN TAP



Rubinetto lavabo elettronico con alimentazione a batteria Electronic basin tap powered by battery Robinet lavabo électronique avec alimentation par batteries. Art. 7035B 7035B



Codice	Riferimenti	Listino A	Listino B	Off.	Box
7035B	1	257,07 €	285,35 €	1	5
7035Bx5	5	246,13 €	273,20 €	1	5



Idroscopino Att/Muro Idral Cr. 02420C



Codice	Riferimenti	Listino A	Listino B	Off.	Box
02420C	1	122,32 €	135,78 €	1	5
02420Cx5	5	117,12 €	130,00 €	1	5

PEDALE ISTANTANEO / INSTANTANEOUS-FLOW PEDAL TAP



Miscelatore a pedale istantaneo a parete/pavimento Instantaneous pedal wall-mounted/floor-mounted mixer Mitigeur instantané à pédale mural/au plancher. Art. 9011 9011



Codice	Riferimenti	Listino A	Listino B	Off.	Box
9011	1	70,76 €	78,54 €	1	5
9011x5	5	67,75 €	75,20 €	1	5

PEDALE MONOACQUA / PEDAL SINGLE-WATER TAP



Rubinetto a pedale temporizzato a parete/pavimento Self-closing pedal wall-mounted/floor-mounted tap Robinet temporisé à pédale mural/au plancher. Art. 9057 9057



Codice	Riferimenti	Listino A	Listino B	Off.	Box
9057	1	63,74 €	70,75 €	1	5
9057x5	5	61,03 €	67,74 €	1	5

Codice	Riferimenti	Listino A	Listino B	Off.	Box
	1	Arrivo	Arrivo	1	5
x5	5	Arrivo	Arrivo	1	5

Codice	Riferimenti	Listino A	Listino B	Off.	Box
	1	Arrivo	Arrivo	1	5
x5	5	Arrivo	Arrivo	1	5

**LAVABO MONOACQUA /
BASIN SINGLE WATER TAP**



Rubinetto lavabo temporizzato Self-closing basin tap Robinet lavabo temporisé. Art. 9001 9001



101free



**LAVABO MISCELATORE /
BASIN MIXER**



Miscelatore lavabo temporizzato Self-closing basin mixer Mitigeur lavabo temporisé. Art. 9007 9007



101free



Codice	Riferimenti	Listino A	Listino B	Off.	Box
9001	1	55,72 €	61,85 €	1	5
9001x5	5	51,17 €	56,80 €	1	5

Codice	Riferimenti	Listino A	Listino B	Off.	Box
9007	1	92,69 €	102,89 €	1	5
9007x5	5	85,13 €	94,49 €	1	5

**BOCCA PER LAVABO /
BASIN SPOUT**



Bocca erogazione fusa a parete Wall fused spout Bec erogation fondu au plancher. Art. 9013 9013



Bocca Erogazione Mon. Ec. C /T. BEMEI

Codice	Riferimenti	Listino A	Listino B	Off.	Box
9013	1	52,04 €	57,77 €	1	5
9013x2	2	31,23 €	34,66 €	1	5

Codice	Riferimenti	Listino A	Listino B	Off.	Box
BEMEI	1	32,57 €	36,16 €	1	5
BEMEIx5	5	26,70 €	29,64 €	1	5



Canna Di Erogazione Girevole Completa H 260 L 350 Basetta Di Fissaggio Su Piano. Idral Cod. 09430 Formata Da Art. 09435+09500-350 BEM350I



Bocca Di Erogazione Lavabo Fissa 02026



Codice	Riferimenti	Listino A	Listino B	Off.	Box
BEM350I	1	86,23 €	95,71 €	1	5
BEM350Ix5	5	79,19 €	87,91 €	1	5

Codice	Riferimenti	Listino A	Listino B	Off.	Box
02026	1	30,94 €	34,34 €	1	5
02026x5	5	26,85 €	29,81 €	1	5

**FLUSSOMETRO INCASSO /
BUILT-IN FLUSH VALVE**



Flussometro ad incasso studiato per il colpo d'ariete, per installazione a parete G3/4 Concealed wall-mounted flush valve studied for water hammer G3/4 Robinet de chasse encastrable étudié pour le coup de bélier, pour installation mural

101free



Pre-miscelatore completo di valvola di non ritorno Pre-mixer complete with non-return valve Pre- mitigeur complet avec clapet anti-retour. Art. 9020ECO 9020ECO

101free



Codice	Riferimenti	Listino A	Listino B	Off.	Box
9455G	1	81,35 €	90,30 €	1	5
9455Gx5	5	74,71 €	82,93 €	1	5

Codice	Riferimenti	Listino A	Listino B	Off.	Box
9020ECO	1	26,51 €	29,42 €	1	5
9020ECOx5	5	24,34 €	27,02 €	1	5



Asciugacapelli Da Parete One Bia 101906004



Asciugamani Elettrico Rocket Bianco 1800 W LFHD1E

Codice	Riferimenti	Listino A	Listino B	Off.	Box
101906004	1	42,84 €	47,55 €	1	5
101906004x5	5	39,50 €	43,85 €	1	5

Codice	Riferimenti	Listino A	Listino B	Off.	Box
LFHD1E	1	67,50 €	74,92 €	1	5
LFHD1Ex5	5	62,24 €	69,09 €	1	5



Maniglione Acciaio Bianco
30Cm Bianco 105H08004



Codice	Offerta	Listino A	Listino B	Conf.	Box
105H08004	1	18,74 €	20,80 €	1	5
105H08004x5	5	17,64 €	19,58 €	1	5



Maniglione Acciaio Bianco
45Cm Bianco 105H09004



Codice	Offerta	Listino A	Listino B	Conf.	Box
105H09004	1	22,22 €	24,67 €	1	5
105H09004x5	5	20,92 €	23,22 €	1	5



Maniglione Acciaio Bianco 60
Cm Bianco 105H10004



Codice	Offerta	Listino A	Listino B	Conf.	Box
105H10004	1	24,90 €	27,64 €	1	5
105H10004x5	5	23,44 €	26,01 €	1	5



Barra D'Appoggio Ribaltabile
70 Cm Bianco 101H12004



Codice	Offerta	Listino A	Listino B	Conf.	Box
101H12004	1	55,44 €	61,54 €	1	2
101H12004x2	2	53,40 €	59,27 €	1	2



Dispenser Per Sapone A Muro
748665

Codice	Offerta	Listino A	Listino B	Conf.	Box
748665	1	4,96 €	5,51 €	1	2
748665x5	5	4,67 €	5,19 €	1	2



Dispenser X Sapone
Schiumogeno A Batteria TX-
9730



Codice	Riferimenti	Listino A	Listino B	Off.	Box
TX-9730	1	13,86 €	15,38 €	1	5
TX-9730x5	5	12,78 €	14,19 €	1	5



Maniglione Acciaio Inox 30Cm
Lucido 105H08100



Codice	Offerta	Listino A	Listino B	Conf.	Box
105H08100	1	27,31 €	30,31 €	1	5
105H08100x5	5	25,70 €	28,53 €	1	5



Maniglione Acciaio Inox 45 Cm
Lucido 105H09100



Codice	Offerta	Listino A	Listino B	Conf.	Box
105H09100	1	28,38 €	31,50 €	1	5
105H09100x5	5	26,71 €	29,65 €	1	5



Maniglione Acciaio Inox 60 Cm
Lucido 105H10100



Codice	Offerta	Listino A	Listino B	Conf.	Box
105H10100	1	32,13 €	35,66 €	1	5
105H10100x5	5	30,24 €	33,57 €	1	5



1 confezione, maniglione a
ventosa 0598.00



Codice	Offerta	Listino A	Listino B	Conf.	Box
0598.00	1	6,71 €	7,45 €	1	10
0598.00x10	10	5,81 €	6,45 €	1	10



Dispenser X Sapone A Muro 2
pulsanti D. 21x15x7 748666

Codice	Offerta	Listino A	Listino B	Conf.	Box
748666	1	7,30 €	8,10 €	1	2
748666x2	2	6,70 €	7,44 €	1	2



Dispenser Genius Sanificante
GNS20NX



Guarda
Video



Codice	Riferimenti	Listino A	Listino B	Off.	Box
GNS20NX	1	208,18 €	231,08 €	1	5
GNS20NXx5	5	179,62 €	199,38 €	1	5



Seduta Per Vasca Regolabile
Bianco 101H48602



Codice	Riferimenti	Listino A	Listino B	Off.	Box
101H48602	1	124,69 €	138,41 €	1	5
101H48602x2	2	114,98 €	127,63 €	1	5



SEDILE A RIBALTA PER
DOCCIA BIANCO
350X328X120 mm.UF
PORTATA KG.200

Import Export

Codice	Riferimenti	Listino A	Listino B	Off.	Box
0527.35	1	88,20 €	97,90 €	1	5
0527.35x5	5	84,95 €	94,29 €	1	5



Seggiolino Vasca Con
Schenale Regolabile In
Larghea 15500



Codice	Riferimenti	Listino A	Listino B	Off.	Box
15500	1	168,52 €	187,06 €	1	5
15500x2	2	154,76 €	171,79 €	1	5



Seduta Ribaltabile Da Muro In
Alluminio Verniciato E
Materiale Plastico Bianco
101M52004



Codice	Riferimenti	Listino A	Listino B	Off.	Box
101M52004	1	78,12 €	86,71 €	1	5
101M52004x2	2	75,24 €	83,51 €	1	5



Sedile Ribaltabile Thermomat
Saniline A Parete T-SPR



Codice	Riferimenti	Listino A	Listino B	Off.	Box
T-SPR	1	223,51 €	248,10 €	1	5
T-SPRx2	2	198,68 €	220,53 €	1	5



Sgabello 4 Gambe Bianco
101H47602

Codice	Riferimenti	Listino A	Listino B	Off.	Box
101H47602	1	47,88 €	53,15 €	1	5
101H47602x2	2	44,15 €	49,01 €	1	5



Specchio Basculante Bianco
101H21004



Codice	Riferimenti	Listino A	Listino B	Off.	Box
101H21004	1	140,24 €	155,66 €	1	5
101H21004x2	2	133,56 €	148,25 €	1	5



Maniglione Bagno Wc
Plastificato

Import Export

Codice	Riferimenti	Listino A	Listino B	Off.	Box
MB30I	1	16,33 €	18,13 €	1	5
MB45I	1	19,60 €	21,76 €	1	5
MB60I	1	26,13 €	29,01 €	1	5



Porta Carta Igenica In Acciaio Inox Foro
Visivo Per Vedere
La Quantita' All'interno, Facile Da Installare
M.: 270 D. 130 pr. 275 mm. H
Con Chiave Di Chiusura



Porta Carta Salviette In Acciaio
Inox Foro Visivo Per Vedere
La Quantita' All'interno
Facile Da Installare
D. 290 Lar. 110 Pr. 270 mm. H
Con Chiave Di Chiusura

Codice	Offerta	Listino A	Listino B	Conf.	Box
0669.27	1	37,59 €	41,73 €	1	5
0669.27x5	5	35,42 €	39,32 €	1	5

Codice	Offerta	Listino A	Listino B	Conf.	Box
0670.29	1	37,59 €	41,73 €	1	5
0670.29x5	5	35,42 €	39,32 €	1	5



Porta Carta Igenica In ABS Bianco Foro
Visivo Per Vedere La Quantita'
All'interno Facile Da Installare
D.: 270 D. 120
Pr. 280 mm. H
Con Chiave Di Chiusura



PORTA SALVIETTA
PALSTICA BIANCO
GR
CHIAVE DI CHIUSA
BOX N.20 56X43X56

Codice	Offerta	Listino A	Listino B	Conf.	Box
0672.27	1	26,85 €	29,80 €	1	5
0672.27x5	5	25,30 €	28,09 €	1	5

Codice	Offerta	Listino A	Listino B	Conf.	Box
0673.27	1	26,85 €	29,80 €	1	5
0673.27x5	5	25,30 €	28,09 €	1	5

ACCESSORI | ACCESSORIES | ACCESSOIRES | ACCESORIOS

Comunità



ARTICOLO / Item
Articolo / Article **10210**

Vaso in Vitreous China Bianca con scarico a terra. Quattro punti di fissaggio e apertura frontale.
Versione scarico Parete

Vaso Disabile Sc.Parete 10210

Codice	Riferimenti	Peso	Conf.	Box	Listino A	Listino B
10210	Offerta PZ 1		1	6	100,08 €	100,08 €
10210X2	Offerta PZ 2		1	6	96,15 €	96,15 €
10210X6	Offerta PZ 6		1	6	92,23 €	92,23 €

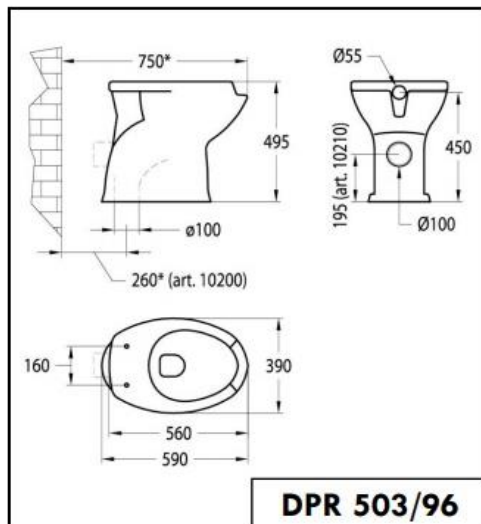

DPR 503/96

ACCESSORI | ACCESSORIES | ACCESSOIRES | ACCESORIOS

Comunità



ARTICOLO / Item
Articolo / Article **10200**

Vaso in Vitreous China Bianca con scarico a terra. Quattro punti di fissaggio e apertura frontale.
Versione scarico Terra

Vaso Disabile Scarico Terra 10200

Codice	Riferimenti	Peso	Conf.	Box	Listino A	Listino B
10200	Offerta PZ 1		1	6	100,08 €	100,08 €
10200x2	Offerta PZ 2		1	6	96,15 €	96,15 €
10200x6	Offerta PZ 6		1	6	92,23 €	92,23 €

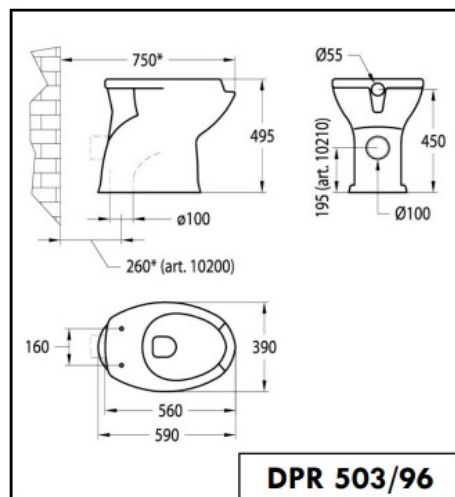

DPR 503/96

ACCESSORI | ACCESSORIES | ACCESSOIRES | ACCESORIOS

Comunità



INSTALLAZIONE DIRETTA A PARETE

INSTALLAZIONE SU MENSOLE

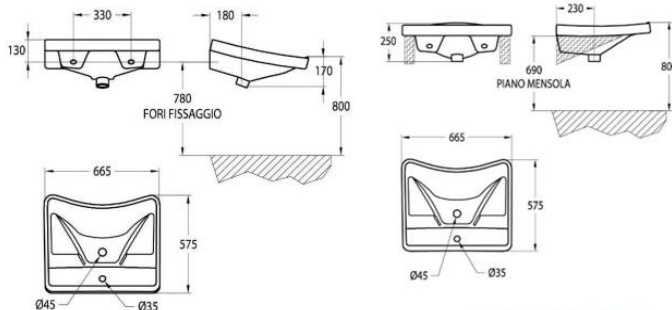

DPR 503/96

Lavabo Ergonomico Disabilis/Troppo Pieno 10192

Codice	Riferimenti	Peso	Conf.	Box	Listino A	Listino B
10192	Offerta PZ 1		1	6	100,08 €	100,08 €
10192x2	Offerta PZ 2		1	6	96,15 €	96,15 €
10192x6	Offerta PZ 6		1	6	92,23 €	92,23 €

ARTICOLO / Item
Articolo / Article

10192

Lavabo ergonomico in Vitreous China bianca per fissaggio a parete (tasselli non inclusi). Senza troppopieno.

Hydraulic is our passion



L'idraulica la nostra Passione
www.hydrosat.eu



ACCESSORI | ACCESSORIES | ACCESSOIRES | ACCESORIOS

Comunità

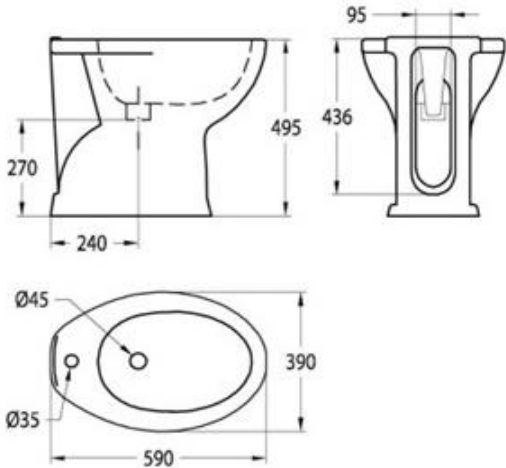

Cod. 10386 Bidet



Codice	Riferimenti	Peso	Conf.	Box	Listino A	Listino B
10386	Offerta PZ 1		1	6	100,08 €	100,08 €
10386x2	Offerta PZ 2		1	6	96,15 €	96,15 €
10386x6	Offerta PZ 6		1	6	92,23 €	92,23 €



ACCESSORI | ACCESSORIES | ACCESSOIRES | ACCESORIOS

Comunità

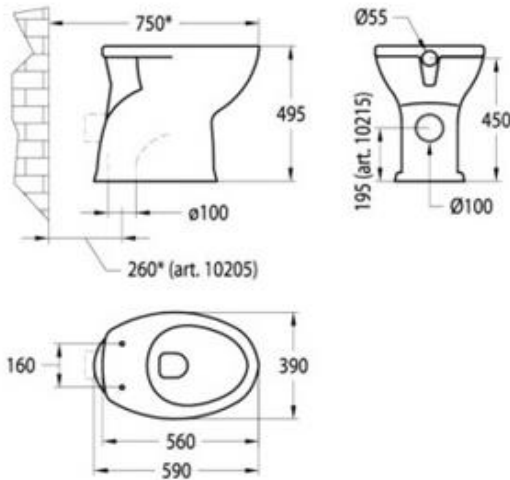

Cod. 10381 Vaso Scarico Terra



Codice	Riferimenti	Peso	Conf.	Box	Listino A	Listino B
10381	Offerta PZ 1		1	6	100,08 €	100,08 €
10381x2	Offerta PZ 2		1	6	96,15 €	96,15 €
10381x6	Offerta PZ 6		1	6	92,23 €	92,23 €

Sedile Wc Bianco Sedile For Life 101E77004

Rialzo Per Seduta Wc Bianco 101R72004



METAFORM®



METAFORM®



Codice	Offerta	Listino A	Listino B	Conf.	Box
101E77004	1	32,13 €	35,66 €	1	5
101E77004x5	5	30,24 €	33,57 €	1	5

Codice	Offerta	Listino A	Listino B	Conf.	Box
101R72004	1	34,81 €	38,64 €	1	5
101R72004x5	5	32,76 €	36,36 €	1	5

ACCESSORI | ACCESSORIES | ACCESSOIRES | ACCESORIOS

Comunità

15101 P

Mensola reclinabile per lavabo. Regolazione a manopola, serie Comunità
 Tilting shelf for basin Knob adjustment, Comunità series
 Support de lavabo inclinable. Réglage à bouton, série Comunità
 Repisa abatible para lavabo. Regulación con pomo, colección Comunità

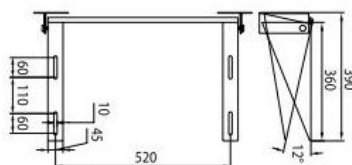

Mensola Reclinabile Lavabo Art. 15101 15101

Codice	Offerta	Peso	Conf.	Box	Listino A	Listino B
15101	Offerta PZ 1		1	24	99,04 €	109,93 €
15101P	Offerta PZ 6		1	24	75,60 €	83,92 €

ACCESSORI | ACCESSORIES | ACCESSOIRES | ACCESORIOS

Comunità

15102 P

Mensola reclinabile per lavabo. Regolazione pneumatica con leva frontale, serie Comunità
 Tilting shelf for basin Pneumatic adjustment with front lever, Comunità series
 Support de lavabo inclinable. Réglage pneumatique avec levier frontal, série Comunità
 Repisa neumática abatible para lavabo. Regulación neumática con palanca frontal, colección Comunità

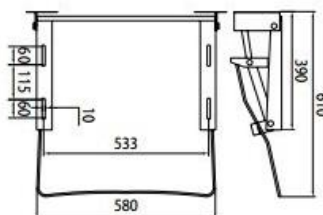

Mensola Pneumatica Reclinabile Art. 15102 15102

Codice	Offerta	Peso	Conf.	Box	Listino A	Listino B
15102	Offerta PZ 1		1	24	200,04 €	222,04 €
15102P	Offerta PZ 6		1	24	189,00 €	209,79 €

ACCESSORI | ACCESSORIES | ACCESSOIRES | ACCESORIOS

Comunità

15100 P

Coppia mensole fisse per lavabo serie Comunità
 Fixed shelves pair for basin Comunità series
 Paire de supports fixes pour lavabo serie Comunità
 Pareja de repisas fijas para lavabo colección Comunità

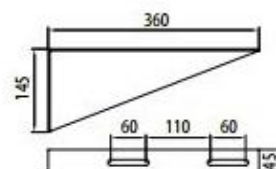

Coppia Mensole Fisse Lavabo Art. 15100 15100

Codice	Offerta	Peso	Conf.	Box	Listino A	Listino B
15100	Offerta PZ 1		1	24	44,19 €	49,05 €
15100P	Offerta PZ 6		1	24	35,36 €	39,25 €

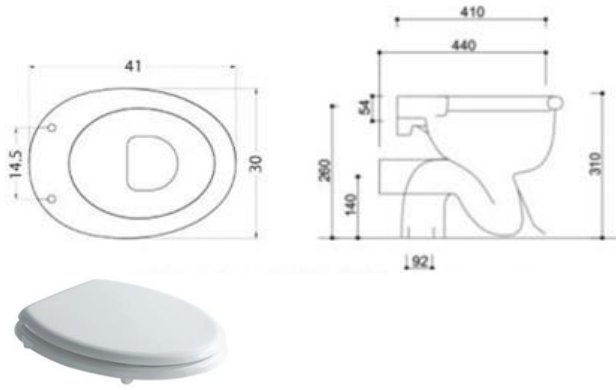

Vaso Infanzia 310X360X300 Scarico Parete AS20P

Codice	Offerta	Listino A	Listino B
		Arrivo	Arrivo
4		Arrivo	Arrivo
6		Arrivo	Arrivo
12		Arrivo	Arrivo

Codice	Offerta	Peso	Conf.	Box	Listino A	Listino B
AS20P			1	12	74,17 €	74,17 €
AS20Px4	4		1	12	60,68 €	60,68 €



SCARICO A PAVIMENTO



Vaso Infanzia 310X360X300 Scarico Terra AS20

Codice	Offerta	Listino A	Listino B
		Arrivo	Arrivo
4		Arrivo	Arrivo
6		Arrivo	Arrivo
12		Arrivo	Arrivo

Codice	Offerta	Peso	Conf.	Box	Listino A	Listino B
AS20			1	12	74,17 €	74,17 €
AS20x4	4		1	12	60,68 €	60,68 €



Softy Riduttore Per Bambini, Soffice, 6 Decori Diversi per Wc Universale

Codice	Offerta	Listino A	Listino B
ARCA099SFT00		9,45 €	9,45 €
ARCA099SFT00x4	4	9,22 €	9,22 €
ARCA099SFT00x6	6	8,86 €	8,86 €
ARCA099SFT00x12	12	8,13 €	8,13 €



VASCA WALK IN 1020X760X965 CON SPORTELLO FRNTALE

ESTERNO 0616.10

Codice	Offerta	Peso	Conf.	Box	Listino A	Listino B
0616.10			1	12	2403,68 €	2547,90 €



VASCA WALK 142X76X99 CON SPORTELLO FRNTALE

ESTERNO 0616.14

Codice	Riferimenti	Peso	Conf.	Box	Listino A	Listino B
0616.14	Offerta PZ 1		1	6	2846,46 €	3017,25 €



CATALOGO LISTINO
PIATTI DOCCIA

EFFETTO ARDESIA



PROFESSIONALITA' E QUALITA'

**EVOklima**™

TECNOLOGIA - BENESSERE - RISPETTO PER L'AMBIENTE

PIATTI DOCCIA STONE RESINA

EFFETTO ARDESIA

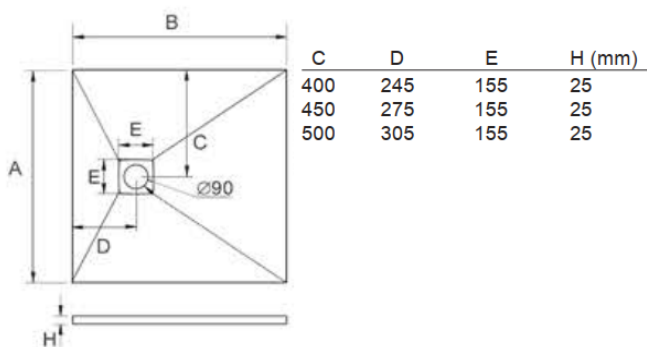

Piatto Doccia Stone Resina Effetto Ardesia Cod. 2090

Codice	Riferimenti	Peso	Conf.	Box	Listino A	Listino B
2090.79	700 x 700	1	20	Arrivo	Arrivo	
2090.80	800 x 800	1	20	176,26 €	186,83 €	
2090.90	900 x 900	1	20	228,66 €	242,38 €	
2090.10	1000 x 1000	1	20	247,71 €	262,58 €	

PIATTI DOCCIA STONE RESINA

EFFETTO ARDESIA

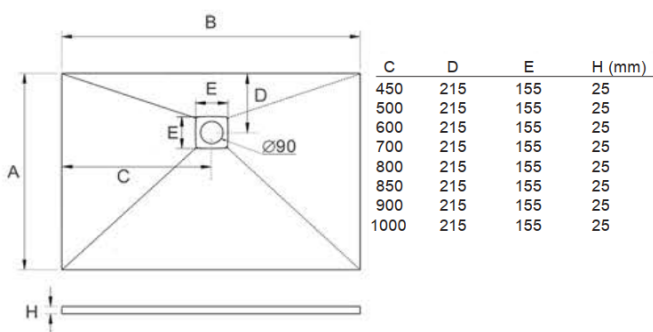

Piatto Doccia Stone Resina Effetto Ardesia Cod. 2100

Codice	Riferimenti	Peso	Conf.	Box	Listino A	Listino B
2100.69	700 x 900	25	1	20	176,26 €	186,83 €
2100.70	700 x 1000	25	1	20	185,79 €	196,93 €
2100.72	700 x 1200	25	1	20	204,84 €	217,13 €
2100.74	700 x 1400	25	1	20	233,42 €	247,43 €
2100.76	700 x 1600	25	1	20	242,95 €	257,53 €
2100.77	700 x 1700	25	1	20	252,48 €	267,63 €
2100.78	700 x 1800	25	1	20	262,01 €	277,73 €
2100.79	700 x 1900	25	1	20	285,82 €	302,97 €
2.100.720	700 x 2000	25	1	20	Arrivo	Arrivo

PIATTI DOCCIA STONE RESINA

EFFETTO ARDESIA

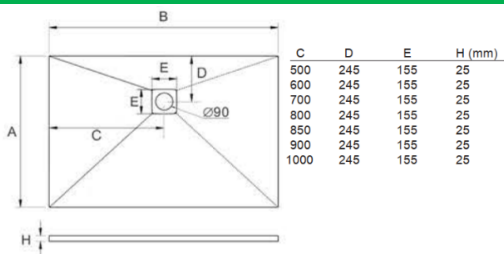

Piatto Doccia Stone Resina Effetto Ardesia Cod. 2100

Codice	Riferimenti	Peso	Conf.	Box	Listino A	Listino B
2100.80	800 x1000	25	1	20	190,55 €	201,98 €
2100.82	800 x1200	25	1	20	219,13 €	232,28 €
2100.84	800 x1400	25	1	20	252,48 €	267,63 €
2100.86	800 x1600	35	1	20	281,06 €	297,92 €
2100.87	800 x1700	35	1	20	290,59 €	308,02 €
2100.88	800 x1800	35	1	20	309,64 €	328,22 €
2100.89	800 x1900	35	1	20	333,46 €	353,47 €
2100.820	800 x2000	35	1	20	89,79 €	95,18 €

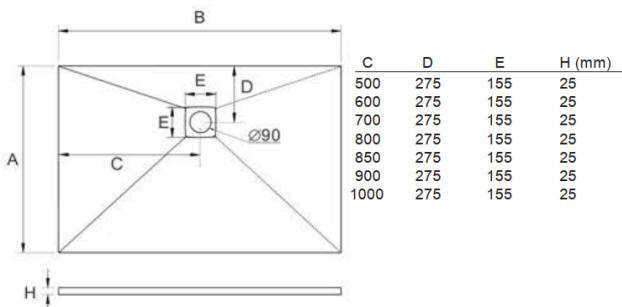

Piatto Doccia Stone Resina Effetto Ardesia Cod. 2100

Codice	Riferimenti	Peso	Conf.	Box	Listino A	Listino B
2100.90	900 x1000	25	1	20	238,19 €	252,48 €
2100.92	900 x1200	25	1	20	262,01 €	277,73 €
2100.94	900 x1400	25	1	20	285,82 €	302,97 €
2100.96	900 x1600	35	1	20	309,64 €	328,22 €
2100.97	900 x1700	35	1	20	333,46 €	353,47 €
2100.98	900 x1800	35	1	20	357,28 €	378,72 €
2100.99	900 x1900	35	1	20	428,74 €	454,46 €
2100.920	900 x2000	35	1	20	455,46 €	482,79 €

PIATTI DOCCIA STONE RESINA
EFFETTO ARDESIA

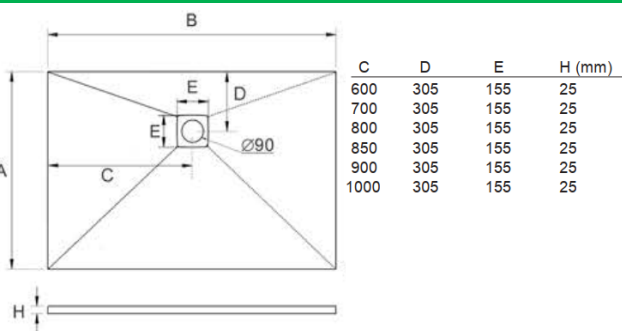

Piatto Doccia Stone Resina Effetto Ardesia Cod. 2100

Codice	Riferimenti	Peso	Conf.	Box	Listino A	Listino B
2100.12	1000 x 1200	35	1	20	309,64 €	328,22 €
2100.14	1000 x 1400	35	1	20	357,28 €	378,72 €
2100.16	1000 x 1600	35	1	20	404,92 €	429,21 €
2100.17	1000 x 1700	35	1	20	428,74 €	454,46 €
2100.18	1000 x 1800	35	1	20	476,37 €	504,96 €
2100.19	1000 x 1900	35	1	20	557,70 €	591,17 €
2100.20	1000 x 2000	35	1	20	571,65 €	605,95 €

PIATTI DOCCIA STONE RESINA
EFFETTO ARDESIA



Promo Piletta e Griglia a Scelta per Acquisto di un Piatto Doccia

Griglia Piastra 150x150x15 mm per piatto doccia con protezione solo acciaio

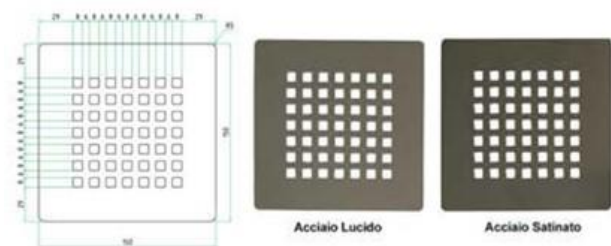

Codice	Riferimenti	Peso	Conf.	Listino A	Listino B
2110.27	Acciaio Lucido	0,40	1	11,71 €	13,00 €
2111.27	Acciaio Satinato	0,40	1	10,04 €	11,14 €

Sifone per piatto doccia foro D.90 mm senza tappo di copertura; completamente ispezionabile; portata > 30 l/min

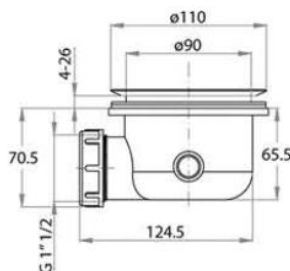

Codice	Riferimenti	Peso	Conf.	Listino A	Listino B
2113.90		0,40	1	16,73 €	17,74 €

Piatto doccia EASY STONE

Piatto doccia rettangolare completa di piletta sifonata 90x120.

Effetto Pietra. Sp. 2,5 cm.

Colore Bianco



ARDESIA PLUS FINITURE



**Tutti i nostri Piatti Doccia Sono Colore Bianco, possono essere forniti colorati. Basta aggiungere all'articolo il codice Ral: esempio
Cod. 7200900709005 Colore Nero
N.B. Vedi % Ricarico Per i Colorati**

Codice Csr	Codice ean	Colore	Misura	Descrizione	Pz	Rif.	Listino A	Listino B
720090070		Bianco	70x90 cm	Piatto doccia EASY	1	1	193,22 €	204,81 €
720100070		Bianco	70x100 cm	Piatto doccia EASY	1	1	199,21 €	211,17 €
720120070		Bianco	70x120 cm	Piatto doccia EASY	1	1	219,23 €	232,38 €
720140070		Bianco	70x140 cm	Piatto doccia EASY	1	1	247,19 €	262,02 €
720160070		Bianco	70x160 cm	Piatto doccia EASY	1	1	254,02 €	269,26 €
720170070		Bianco	70x170 cm	Piatto doccia EASY	1	1	262,52 €	278,27 €
720180070		Bianco	70x180 cm	Piatto doccia EASY	1	1	268,80 €	284,92 €
720200070		Bianco	70x200 cm	Piatto doccia EASY	1	1	296,10 €	313,86 €
720080080		Bianco	80x80 cm	Piatto doccia EASY	1	1	193,70 €	205,32 €
720100080		Bianco	80x100 cm	Piatto doccia EASY	1	1	208,07 €	220,55 €
720120080		Bianco	80x120 cm	Piatto doccia EASY	1	1	233,07 €	247,05 €
720140080		Bianco	80x140 cm	Piatto doccia EASY	1	1	261,21 €	276,88 €
720160080		Bianco	80x160 cm	Piatto doccia EASY	1	1	289,09 €	306,44 €
720170080		Bianco	80x170 cm	Piatto doccia EASY	1	1	295,64 €	313,38 €
720180080		Bianco	80x180 cm	Piatto doccia EASY	1	1	304,40 €	322,66 €
720200080		Bianco	80x200 cm	Piatto doccia EASY	1	1	324,59 €	344,07 €
720090090		Bianco	90x90 cm	Piatto doccia EASY	1	1	224,34 €	237,80 €
720100090		Bianco	90x100 cm	Piatto doccia EASY	1	1	243,72 €	258,34 €
720120090		Bianco	90x120 cm	Piatto doccia EASY	1	1	252,83 €	268,00 €
720140090		Bianco	90x140 cm	Piatto doccia EASY	1	1	268,04 €	284,12 €
720160090		Bianco	90x160 cm	Piatto doccia EASY	1	1	295,87 €	313,62 €
720170090		Bianco	90x170 cm	Piatto doccia EASY	1	1	323,63 €	343,05 €
720180090		Bianco	90x180 cm	Piatto doccia EASY	1	1	332,28 €	352,22 €
720200090		Bianco	90x200 cm	Piatto doccia EASY	1	1	418,21 €	443,31 €
720100100		Bianco	100x100 cm	Piatto doccia EASY	1	1	257,87 €	273,34 €
720120100		Bianco	100x120 cm	Piatto doccia EASY	1	1	263,89 €	279,72 €
720140100		Bianco	100x140 cm	Piatto doccia EASY	1	1	298,83 €	316,76 €
720160100		Bianco	100x160 cm	Piatto doccia EASY	1	1	392,28 €	415,81 €
720170100		Bianco	100x170 cm	Piatto doccia EASY	1	1	419,17 €	444,32 €
720180100		Bianco	100x180 cm	Piatto doccia EASY	1	1	445,84 €	472,59 €
720200100		Bianco	100x200 cm	Piatto doccia EASY	1	1	445,84 €	472,59 €

?

LA SCELTA FACILE

Attrezzi per idraulici



Pressatici manuale e batteria

Siliconi prodotti chimici



Filiere Tagliatubi manuali ed elettrici



Fissaggi





Collare Pesante completo di tassello

Codice	Riferimenti	Listino A	Listino B	Off.	Box
CL14	D.14	0,49 €	0,55 €	1	50
CL16	D.16	0,50 €	0,55 €	1	50
CL18	D.18	0,51 €	0,57 €	1	50
CL20	D.20	0,52 €	0,57 €	1	50
CL22	D.22	0,56 €	0,62 €	1	50
CL24	D.24	0,54 €	0,59 €	1	50
CL26	D.26	0,54 €	0,60 €	1	50
CL28	D.28	0,55 €	0,61 €	1	50
CL32	D.32	0,55 €	0,61 €	1	50
CL40	D.40	0,76 €	0,84 €	1	50
CL50	D.40	0,70 €	0,77 €	1	50
CL63	D.40	Arrivo	Arrivo	1	50



Collare Pesante completo di tassello

Codice	Riferimenti	Listino A	Listino B	Off.	Box
CPT1\2	D.1/2"	0,58 €	0,64 €	1	50
CPT3\4	D.3/4"	0,62 €	0,69 €	1	50
CPT1	D.1"	0,64 €	0,71 €	1	50
CPT11\4	D.1"1/4	0,68 €	0,75 €	1	50
CPT11\2	D.1"1/2	0,72 €	0,79 €	1	50
CPT2	D.2"	0,82 €	0,91 €	1	50
CPT21\2	D.2"1/2	1,84 €	2,04 €	1	50
CPT3	D.3"	1,57 €	1,74 €	1	50
CPT4	D.4"	1,87 €	2,08 €	1	50



Collare leggero per Pluviale

Codice	Riferimenti	Listino A	Listino B	Off.	Box
CL80	D.80	0,84 €	0,93 €	1	50
CL100	D.100	0,87 €	0,97 €	1	50
CL125	D.125	0,96 €	1,06 €	1	50



Collare Zincato pesante per tubi PEHD-PVC

Codice	Riferimenti	Listino A	Listino B	Off.	Box
CP140	D. 140	2,88 €	3,20 €	1	50
CP160	D. 160	2,98 €	3,31 €	1	50
CP200	D. 200	3,20 €	3,56 €	1	50
CP250	D. 250	Arrivo	Arrivo	1	50
CP315	D. 315	Arrivo	Arrivo	1	50



Collare leggero per Pluviale
Colore rame

Codice	Riferimenti	Listino A	Listino B	Off.	Box
CL80R	D.80	2,51 €	2,78 €	1	50
CL100R	D.100	2,79 €	3,09 €	1	50
CL125R	D.125	2,25 €	2,50 €	1	50



Collare leggero per Pluviale
Colore Marrone

Codice	Riferimenti	Listino A	Listino B	Off.	Box
CL80M	D.80	0,83 €	0,92 €	1	50
CL100M	D.100	0,88 €	0,98 €	1	50
CL125M	D.125	Arrivo	Arrivo	1	50



Collare leggero per Pluviale
Colore Marrone

Codice	Riferimenti	Listino A	Listino B	Off.	Box
CL80QR	D.80	Arrivo	Arrivo	1	50
CL100QR	D.100	Arrivo	Arrivo	1	50
CL125QR	D.125	Arrivo	Arrivo	1	50



Collare leggero per Pluviale
Colore Marrone

Codice	Riferimenti	Listino A	Listino B	Off.	Box
CL80QM	D.80	0,96 €	1,06 €	1	50
CL100QM	D.100	1,33 €	1,47 €	1	50
CL125QM	D.125	Arrivo	Arrivo	1	50



C2108V Collare Fiss. Tubi Fumo
D. 80 C2108V

C2110V Collare Fiss. Tubi Fumo
D.100 C2110V

Codice	Riferimenti	Listino A	Listino B	Off.	Box
C2108V	D. 80	2,47 €	2,74 €	1	50
C2110V	D. 100	2,59 €	2,88 €	1	50



C2090V Collare Regolabile 80-140 B.Co C2090V

C2191V Collare Regolabile 140-200 B. C2191V

Codice	Riferimenti	Listino A	Listino B	Off.	Box
C2090V	D. 80-140	3,06 €	3,40 €	1	50
C2191V	D. 140-200	3,67 €	4,08 €	1	50

GSL**GSL** - Graffette singole leggere in acciaio zincatoPREZZO
(x BOX)

Codice	Riferimenti	Listino A	Listino B	Off.	Box
GSL16	D. 16	0,08 €	0,08 €	1	100
GSL20	D. 20	0,09 €	0,10 €	1	100
GSL22	D. 22	0,11 €	0,12 €	1	100
GSL26	D. 26	0,13 €	0,15 €	1	100
GSL28	D. 28	0,15 €	0,17 €	1	100
GSL32	D. 32	0,19 €	0,21 €	1	50
GSL40	D. 40	0,25 €	0,28 €	1	50
GSL50	D. 50	0,30 €	0,33 €	1	50

GDP**GDP** - Graffette doppie pesanti in acciaio zincatoPREZZO
(x BOX)

Codice	Riferimenti	Listino A	Listino B	Off.	Box
GDP16	D. 16	0,161 €	0,178 €	1	100
GDP18	D. 18	0,162 €	0,180 €	1	100
GDP20	D. 20	0,183 €	0,203 €	1	100
GDP22	D. 22	0,202 €	0,224 €	1	50
GDP28	D. 28	0,276 €	0,306 €	1	50
GDP37	D. 37	0,243 €	0,270 €	1	50

AV**AV** Tasselli in nylon + vite combinataExtra 10%
(x BOX)

Codice	Riferimenti	Listino A	Listino B	Off.	Box
AV9X40	9x40	0,253 €	0,281 €	5	200
AV9X50	9x50	0,381 €	0,423 €	5	200
AV12X43	12x43	0,322 €	0,358 €	5	100
AV12X53	12x53	0,482 €	0,535 €	5	100

RC**RC** Tasselli in nylon + gancio cortoExtra 10%
(x BOX)

Codice	Riferimenti	Listino A	Listino B	Off.	Box
RC9X40	9x40	0,253 €	0,281 €	5	200
RC9X50	9x50	0,381 €	0,423 €	5	200
RC12X43	12x43	0,322 €	0,358 €	5	100
RC12X53	12x53	0,482 €	0,535 €	5	100

RM**RM** Tasselli in nylon + gancio medioExtra 10%
(x BOX)

Codice	Riferimenti	Listino A	Listino B	Off.	Box
RM9X40	9x40	0,257 €	0,285 €	5	200
RM9X50	9x50	0,377 €	0,418 €	5	200
RM12X43	12x43	0,346 €	0,384 €	5	100
RM12X53	12x53	0,480 €	0,532 €	5	100

RL**RL** Tasselli in nylon + gancio lungoExtra 10%
(x BOX)

Codice	Riferimenti	Listino A	Listino B	Off.	Box
RL9X40	9x40	0,271 €	0,301 €	5	200
RL12X43	12x43	0,349 €	0,388 €	5	100

OA**OA** Tasselli in nylon + occhio apertoExtra 10%
(x BOX)

Codice	Riferimenti	Listino A	Listino B	Off.	Box
OA9X40	9x40	0,309 €	0,343 €	5	200
OA12X43	12x43	0,383 €	0,426 €	5	100

OC**OC** Tasselli in nylon + occhio chiusoExtra 10%
(x BOX)

Codice	Riferimenti	Listino A	Listino B	Off.	Box
OC9X40	9x40	0,309 €	0,343 €	5	200
OC9X50	9x50	0,431 €	0,479 €	5	150
OC12X43	12x43	0,383 €	0,426 €	5	100
OC12X53	12x53	0,528 €	0,586 €	5	50

DD**DD** Tasselli in nylon + asta filettata con doppio dadoExtra 10%
(x BOX)

Codice	Riferimenti	Listino A	Listino B	Off.	Box
DD9X40	9X40	0,398 €	0,441 €	5	100
DD12X43	12x43	0,543 €	0,603 €	5	50

F4V/TE**F4V/TE** - Tasselli in nylon F4 + tirafondo e rondellaPREZZO
(x BOX)

Codice	Riferimenti	Listino A	Listino B	Off.	Box
F4VTE08	08 TE 5X60	0,36 €	0,40 €	1	100
F4VTE10	10 TE 6X60	0,61 €	0,68 €	1	100
F4VTE12	12 TE 8X70	0,81 €	0,90 €	1	50
F4VTE14	14 TE 10X80	1,11 €	1,24 €	1	50

NPS

NPS - Tasselli rapidi a percussione in nylon bordo svasato con vite a chiodo premontata impronta a croce pozidriv



PREZZO
(x BOX)



Codice	Riferimenti	Listino A	Listino B	Off.	Box
SMP2811	5x35	0,079 €	0,087 €	1	200
SMP2812	5x50	0,079 €	0,088 €	1	200
SMP2813	6x40	0,090 €	0,100 €	1	200
SMP2814	6x50	0,096 €	0,106 €	1	150
SMP2815	6x60	0,108 €	0,120 €	1	100
SMP2817	6x80	0,137 €	0,153 €	1	100
SMP2819	8x60	0,151 €	0,167 €	1	100
SMP2820	8x80	0,194 €	0,216 €	1	150
SMP2821	8x100	0,27 €	0,30 €	1	100
SMP2822	8x125	0,31 €	0,35 €	1	100

FB

FB - Tasselli in nylon Profix con bordo



PREZZO
(x BOX)



Codice	Riferimenti	Listino A	Listino B	Off.	Box
FEB805	5x25	0,014 €	0,016 €	1	200
FEB806	6x30	0,016 €	0,018 €	1	200
FEB808	8x40	0,028 €	0,031 €	1	100
FEB810	10x50	0,054 €	0,060 €	1	50

Confezione TASSELLO NYLON CON VITE ZINCATA TSP



PREZZO
(x BOX)



Codice	Riferimenti	Listino A	Listino B	Off.	Box
SMP1351P	5x3,5x40	6,87 €	7,62 €	1	150
SMP1352FE	6x4x40	4,13 €	4,59 €	1	100
SMP1432	6x4,5x40	4,93 €	5,48 €	1	100
SMP1353FE	8x5x45	4,13 €	4,59 €	1	50

SL140 Supporto Per Lavabo 140X10 Tassello D.14 SL140



SL180 Supporto Per Lavabo 180X10 Tassello D.14 SL180

Codice	Riferimenti	Listino A	Listino B	Off.	Box
SL140	10X140	1,57 €	1,74 €	1	10
SL180	10X160	1,85 €	2,05 €	1	10

SS100 Supporto Scaldino 8X70 Tas. 10 SS100



SS140 Supporto Scaldabagno 10X140 SS140

Codice	Riferimenti	Listino A	Listino B	Off.	Box
SS100	8X70	0,72 €	0,80 €	1	10
SS140	10X140	1,56 €	1,73 €	1	10

HBRV

HBRV - Tasselli prolungati in nylon + viti TSP croce



PREZZO
(x BOX)



Codice	Riferimenti	Listino A	Listino B	Off.	Box
SMP2521	08x80 V 5,5x85	0,359 €	0,398 €	1	100
SMP2522	8x100 V 5,5x105	0,467 €	0,518 €	1	100
SMP2523	8x120 V 5,5x125	0,507 €	0,562 €	1	100
SMP2524	10x80 V 7x85	0,623 €	0,691 €	1	100
SMP2525	10x10 V 7x105	0,650 €	0,722 €	1	50
SMP2526	10x115 V 7x12	0,716 €	0,794 €	1	50
SMP2527	10x135 V 7x14	0,799 €	0,887 €	1	50
SMP2528	10x16 V 7x165	1,030 €	1,143 €	1	50

AR

AR - TASSELLI PROLUNGATI IN NYLON



PREZZO
(x BOX)



Codice	Riferimenti	Listino A	Listino B	Off.	Box
AR06060	6X60	13,06 €	14,50 €	1	200
AR08060	8X60	19,01 €	21,10 €	1	200
AR08080	8X80	11,14 €	12,37 €	1	100
AR08100	8X100	13,06 €	14,50 €	1	100
AR08120	8X120	15,99 €	17,75 €	1	100
AR10080	10X80	16,44 €	18,25 €	1	100
AR10100	10X100	19,94 €	22,13 €	1	100
AR10115	10X115	20,91 €	23,21 €	1	100
AR10135	10X135	23,42 €	26,00 €	1	100
AR10160	10X160	26,44 €	29,35 €	1	100

ARV

ARV - Tasselli prolungati in nylon + viti TSP croce



PREZZO
(x BOX)



Codice	Riferimenti	Listino A	Listino B	Off.	Box
SMP2421	6X60 V 4X64	0,168 €	0,186 €	1	200
SMP2422	8X60 V 5,5X65	0,231 €	0,256 €	1	200
SMP2423	8X80 V 5,5X85	0,257 €	0,285 €	1	100
SMP2424	8X100 v 5,5X105	0,336 €	0,373 €	1	100
SMP2425	8X120 v 5,5X125	0,401 €	0,445 €	1	100
SMP2426	10X80 V 7X85	0,421 €	0,467 €	1	100
SMP2427	10X100 V 7X105	0,483 €	0,537 €	1	50
SMP2428	10X115 V 7X120	0,581 €	0,645 €	1	50
SMP2429	10X135 V 7X140	0,668 €	0,742 €	1	50
SMP2430	10X160 V 7X165	0,808 €	0,897 €	1	50

SST Supporto Sanitari Terra 4 Pz SST



Codice	Riferimenti	Listino A	Listino B	Off.	Box
SST	tropicalizzato	1,69 €	1,88 €	1	10



**DAZ - Dado esagonale
zincato bianco - DIN 934 -
UNI 5588**

PREZZO
(x 100 pz)



Codice	Riferimenti	Listino A	Listino B	Off.	Box
DAG05	M 5x25	0,143 €	0,159 €	1	100
DAG06	M 6x30	0,204 €	0,226 €	1	100
DAG08	M 8x40	0,448 €	0,497 €	1	100
DAG10	M 10x45	0,396 €	0,439 €	1	100
DAG12	M 12x50	0,538 €	0,597 €	1	100



**SAFZ - Asta filettata a tutto
filetto zincata bianca mt.1
classe 4.8**

PREZZO
(x 100 pz)



Codice	Riferimenti	Listino A	Listino B	Off.	Box
AFZ04	M 4	0,003 €	0,003 €	1	200
AFZ05	M 5	0,005 €	0,006 €	1	150
AFZ06	M 6	0,009 €	0,010 €	1	100
AFZ08	M 8	0,029 €	0,033 €	1	50
AFZ10	M 10	0,087 €	0,096 €	1	25
AFZ12	M 12	0,160 €	0,178 €	1	20
AFZ14	M 14	0,454 €	0,503 €	1	10
AFZ16	M 16	0,627 €	0,696 €	1	10
AFZ18	M 18	1,576 €	1,750 €	1	5
AFZ20	M 20	1,952 €	2,167 €	1	5



**DAZ - Dado esagonale
zincato bianco - DIN 934 -
UNI 5588**

PREZZO
(x 100 pz)



Codice	Riferimenti	Listino A	Listino B	Off.	Box
DAZ03	M 3	0,130 €	0,144 €	1	100
DAZ04	M 4	0,167 €	0,186 €	1	100
DAZ05	M 5	0,102 €	0,113 €	1	100
DAZ06	M 6	0,172 €	0,191 €	1	100
DAZ08	M 8	0,184 €	0,204 €	1	100
DAZ10	M 10	0,165 €	0,183 €	1	100
DAZ12	M 12	0,248 €	0,275 €	1	100



**RON - Rondelle piane
zincate bianche**

PREZZO
(x 100 pz)



Codice	Riferimenti	Listino A	Listino B	Off.	Box
RON04	M 4 X 9	0,070 €	0,077 €	1	100
RON05	M 5 x 10	0,093 €	0,103 €	1	100
RON06	M 6 x 12	0,144 €	0,160 €	1	100
RON08	M 8 x 16	0,237 €	0,263 €	1	100
RON10	M 10 x 20	0,223 €	0,248 €	1	100
RON12	M 12 x 24	0,376 €	0,418 €	1	100
RON14	M 14 x 28	0,639 €	0,709 €	1	100
RON18	M 18 x 36	0,688 €	0,763 €	1	100



**Supporto Sanitari Laterale
Multiforo SSL**

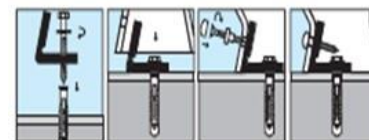

Codice	Riferimenti	Listino A	Listino B	Off.	Box
SSL		3,87 €	4,29 €	1	10



**BTE - Viti TE zincate
bianche cl. 8.8 interamente
filettate**

PREZZO
(x 100 pz)



Codice	Riferimenti	Listino A	Listino B	Off.	Box
BTE08020	8 x 20	0,275 €	0,305 €	1	100
BTE08025	8 x 25	0,307 €	0,340 €	1	100
BTE08030	8 x 30	0,339 €	0,377 €	1	100
BTE08035	8 x 35	0,374 €	0,415 €	1	100
BTE08040	8 x 40	0,407 €	0,452 €	1	100
BTE08050	8 x 50	0,476 €	0,528 €	1	100
BTE10020	10 x 20	0,533 €	0,591 €	1	100
BTE10025	10 x 25	0,579 €	0,643 €	1	100
BTE10030	10 x 30	0,315 €	0,350 €	1	100
BTE10035	10 x 35	0,338 €	0,375 €	1	100
BTE10040	10 x 40	0,359 €	0,399 €	1	100
BTE10050	10 x 50	0,409 €	0,454 €	1	100
BTE12020	12 x 20	0,571 €	0,634 €	1	100
BTE12025	12 x 25	0,415 €	0,461 €	1	100
BTE12030	12 x 30	0,453 €	0,503 €	1	100
BTE12035	12 x 35	0,487 €	0,540 €	1	100
BTE12040	12 x 40	0,517 €	0,574 €	1	100
BTE14050	14 x 50	0,449 €	0,498 €	1	100
BTE14020	14 x 20	0,683 €	0,758 €	1	100
BTE14025	14 x 25	0,709 €	0,787 €	1	100
BTE14030	14 x 30	0,713 €	0,792 €	1	100
BTE14035	14 x 35	0,754 €	0,837 €	1	100
BTE14040	14 x 40	0,802 €	0,890 €	1	100
BTE14050	14 x 50	0,449 €	0,498 €	1	100



**RON - Rondelle piane
larghe zincate bianche**

PREZZO
(x 100 pz)



Codice	Riferimenti	Listino A	Listino B	Off.	Box
RON04012	M 4 X 12	0,184 €	0,204 €	1	100
RON05015	M 5 x 15	0,204 €	0,227 €	1	100
RON05020	M 5 x 20	0,469 €	0,521 €	1	100
RON06018	M 6 x 18	0,311 €	0,346 €	1	100
RON06024	M 6 x 24	0,344 €	0,382 €	1	100
RON08024	M 8 x 24	0,316 €	0,351 €	1	100
RON08032	M 8 x 32	0,445 €	0,494 €	1	100
RON10030	M 10 x 30	0,266 €	0,295 €	1	100
RON10040	M 10 x 40	0,264 €	0,293 €	1	100
RON12036	M 12 x 36	0,244 €	0,271 €	1	100



21740 Bandella Forata 12 Mm Spessore 0,7 Mm Rotolo Da 10 Mt.

21741 Bandella Forata 17 Mm Spessore 0,7 Mm Rotolo Da 10 Mt.

Codice	Riferimenti	Listino A	Listino B	Off.	Box
21740		9,04 €	10,03 €	1	10
21741		10,07 €	11,18 €	1	10



FCV - Fascette per cablaggio in nylon pa 6.6 - COLORE VERDE

Codice	Riferimenti	Listino A	Listino B	Off.	Box
FCV25100	100 x 2,5	0,013 €	0,015 €	1	100
FCV36140	140 x 3,6	0,033 €	0,036 €	1	100
FCV36200	200 x 3,6	0,050 €	0,055 €	1	100
FCV48200	200 x 4,8	0,059 €	0,066 €	1	100
FCV48300	300 x 4,8	0,095 €	0,106 €	1	100



FCB - Fascette per cablaggio in nylon pa 6.6 - COLORE BIANCO

PREZZO (x BOX)

Codice	Riferimenti	Listino A	Listino B	Off.	Box
FCB25100	mm. 100 x 2,5	0,012 €	0,013 €	1	100
FCB25140	mm. 140 x 2,5	0,025 €	0,027 €	1	100
FCB25160	mm. 160 x 2,5	0,031 €	0,035 €	1	100
FCB26200	mm. 200 x 2,6	0,034 €	0,038 €	1	100
FCB35140	mm. 140 x 3,5	0,029 €	0,032 €	1	100
FCB35200	mm. 200 x 3,5	0,044 €	0,049 €	1	100
FCB35290	mm. 290 x 3,5	0,060 €	0,066 €	1	100
FCB35370	mm. 370 x 3,5	0,106 €	0,117 €	1	100
FCB48160	mm. 160 x 4,8	0,042 €	0,046 €	1	100
FCB48200	mm. 200 x 4,8	0,052 €	0,058 €	1	100
FCB48250	mm. 250 x 4,8	0,077 €	0,085 €	1	100
FCB48290	mm. 290 x 4,8	0,084 €	0,094 €	1	100
FCB48360	mm. 360 x 4,8	0,104 €	0,115 €	1	100



FCN - Fascette per cablaggio in nylon pa 6.6 - COLORE NERO

PREZZO (x BOX)

Codice	Riferimenti	Listino A	Listino B	Off.	Box
FCN25100	mm. 100 x 2,5	0,0118 €	0,0131 €	1	100
FCN25140	mm. 140 x 2,5	0,0245 €	0,0272 €	1	100
FCN25160	mm. 160 x 2,5	0,0313 €	0,0348 €	1	100
FCN26200	mm. 200 x 2,6	0,0338 €	0,0375 €	1	100
FCN35140	mm. 140 x 3,5	0,0289 €	0,0321 €	1	100
FCN35200	mm. 200 x 3,5	0,0443 €	0,0491 €	1	100
FCN35290	mm. 290 x 3,5	0,0598 €	0,0664 €	1	100
FCN35370	mm. 370 x 3,5	0,1058 €	0,1174 €	1	100
FCN48160	mm. 160 x 4,8	0,0418 €	0,0464 €	1	100
FCN48200	mm. 200 x 4,8	0,0523 €	0,0580 €	1	100
FCN48250	mm. 250 x 4,8	0,0767 €	0,0851 €	1	100
FCN48290	mm. 290 x 4,8	0,0843 €	0,0935 €	1	100

CFF

CFF Fascette a collare



PREZZO (x BOX)

Codice	Riferimenti	Listino A	Listino B	Off.	Box
CFF1632	16<>32	0,278 €	0,308 €	1	100
CFF4063	40<>63	0,463 €	0,514 €	1	100

CFM

CFM - Clip fissatubo a morsetto regolabile



PREZZO (x BOX)

Codice	Riferimenti	Listino A	Listino B	Off.	Box
CFM22	da mm. 14 a 22	0,470 €	0,522 €	1	100
CFM35	da mm. 23 a 35	0,703 €	0,780 €	1	100

Fascette Stringitubo in acciaio BANDA LARGHEZZA 9 mm



PREZZO (x BOX)

Codice	Riferimenti	Listino A	Listino B	Off.	Box
FST09012	8<>12	0,061 €	0,068 €	100	600
FST09016	10<>16	0,046 €	0,051 €	100	600
FST09020	12<>20	0,070 €	0,078 €	100	600
FST09025	16<>25	0,055 €	0,061 €	100	600
FST09032	20<>32	0,079 €	0,088 €	100	600
FST09040	25<>40	0,083 €	0,092 €	100	600
FST09050	32<>50	0,093 €	0,103 €	50	300

Fascette Stringitubo in acciaio BANDA LARGHEZZA 12 mm



PREZZO (x BOX)

Codice	Riferimenti	Listino A	Listino B	Off.	Box
FST12025	16 / 25	0,0832 €	0,0923 €	100	600
FST12032	20 / 32	0,0925 €	0,1027 €	100	600
FST12040	25 / 40	0,0962 €	0,1068 €	100	600
FST12050	32 / 50	0,0581 €	0,0645 €	100	600
FST12060	40 / 60	0,0633 €	0,0703 €	100	600
FST12070	50 / 70	0,0726 €	0,0806 €	100	600
FST12080	60 / 80	0,1530 €	0,1698 €	50	300
FST12100	80 / 100	0,0878 €	0,0975 €	50	300
FST12120	100 / 120	0,0972 €	0,1079 €	50	300
FST12140	120 / 140	0,1085 €	0,1205 €	50	300
FST12160	140 / 160	0,1212 €	0,1346 €	50	300



PROFESSIONALE PER RACCORDI
MULTISTRATO IN VALIGIA
COMPLETA DI INSERTI DA 16/20/26
CON PROFILO TH

Codice	Riferimenti	Listino A	Listino B	Off.	Box
PS000003	Valigetta	250,49 €	278,04 €	1	50



INSERTO PROFILO TH PER
PRESSATRICE
PS000003-PS000004

Codice	Riferimenti	Listino A	Listino B	Off.	Box
34ITH16	D. 16 mm	28,84 €	32,02 €	1	50
34ITH20	D. 20 mm	28,84 €	32,02 €	1	50
34ITH26	D. 26 mm	28,84 €	32,02 €	1	50



Chiave Universale Per
Tappi Radiatori
DRACHIAVE

Codice	Riferimenti	Listino A	Listino B	Off.	Box
DRACHIAVE		4,78 €	5,31 €	1	50



Chiave per dadi rubinetti
con testa snodata

Codice	Riferimenti	Listino A	Listino B	Off.	Box
PRTS		28,84 €	32,02 €	1	50



Chiave Universale Per
Fissaggio Supporti
Copriwater CUPC01

Codice	Riferimenti	Listino A	Listino B	Off.	Box
CUPC01		18,98 €	21,06 €	1	50



Mini Archetto Per Metallo
Con Arco
Orientabile MINIARC01

Codice	Riferimenti	Listino A	Listino B	Off.	Box
MINIARC01		7,41 €	8,22 €	1	50



Seghetto Puk Manico Pvc
Ec. SPPE

Codice	Riferimenti	Listino A	Listino B	Off.	Box
SPPE		4,35 €	4,83 €	1	50



Pressatrice Professionale A Batteria
per raccordi tubi multistrato
Completa di inserti D. 16-20-26 mm
con profilo TH

Codice	Riferimenti	Listino A	Listino B	Off.	Box
PS000004	Valigetta	1262,56 €	1401,45 €	1	50



GANASCIA COMPLETA DI
INSERTO PROFILO TH D. 32
PER PRESSATRICE
PS000004

Codice	Riferimenti	Listino A	Listino B	Off.	Box
GPS26	D. 26 mm	Arrivo	Arrivo	1	50
GPS32	D. 32 mm	202,42 €	224,68 €	1	50



Kit per tubo multistrato

- 1) cesoia da 0-32 mm
- 1) Calibratore 14-16-18-20-26-32 mm

Codice	Riferimenti	Listino A	Listino B	Off.	Box
KITCC32		12,21 €	13,56 €	1	50



Fresa Per Rettifica Sede
Rub. 32140

Codice	Riferimenti	Listino A	Listino B	Off.	Box
32140	3/8"-1/2"	6,83 €	7,58 €	1	50



Chiave Per Codoli
Radiatore
Da 3/8" A 1" CPCRM

Codice	Riferimenti	Listino A	Listino B	Off.	Box
CPCRM		30,36 €	33,70 €	1	50



Seghetto Puk A Mano
prodotto di qualità 8104201

Codice	Riferimenti	Listino A	Listino B	Off.	Box
8104201		5,53 €	6,13 €	1	50



Seghetto Puk 65X250 SPE

Codice	Riferimenti	Listino A	Listino B	Off.	Box
SPE		3,36 €	3,73 €	1	50

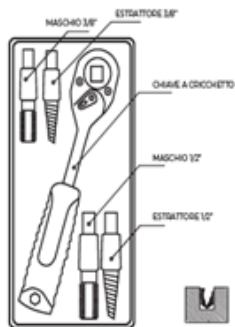

KIT ESTRATTORI PER RACCORDI FILETTATI

d. 3/82 - 1/2"



Codice	Riferimenti	Listino A	Listino B	Off.	Box
DES3812		Arrivo	Arrivo	1	50

Chiave Per Piletta DCHP



Codice	Riferimenti	Listino A	Listino B	Off.	Box
DCHP		27,83 €	30,89 €	1	50

Chiave Universale Snodata Per Montaggio Miscelatori Con Inserto Magnetico Da 13 Mm



Codice	Riferimenti	Listino A	Listino B	Off.	Box
DCUR001	13 mm	22,16 €	24,60 €	1	50

Chiave Universale Assemblaggio Radiatori CHIASR



Codice	Riferimenti	Listino A	Listino B	Off.	Box
CHIASR	D. 1"	Arrivo	Arrivo	1	50

Squadra combinata 250 mm lega in alluminio con livella 8103955



Codice	Riferimenti	Listino A	Listino B	Off.	Box
8103955	mm 250	6,37 €	7,07 €	1	50

Tenaglia Per Muratore Extra



Codice	Riferimenti	Listino A	Listino B	Off.	Box
120340	extra 220	12,65 €	14,04 €	1	12
120350	extra 250	14,57 €	16,18 €	1	12
120355	extra 280	17,03 €	18,90 €	1	12



Livello Esprit 2 bolle

Codice	Riferimenti	Listino A	Listino B	Off.	Box
124125	cm. 30	Arrivo	Arrivo	1	50
124126	cm. 40	21,86 €	24,27 €	1	50
124128	cm. 60	29,02 €	32,21 €	1	50
124130	cm. 80	37,95 €	42,13 €	1	50

Kit 3 Chiavi Fissaggio Miscelatori DSETCACF



Codice	Riferimenti	Listino A	Listino B	Off.	Box
DSETCACF	3 pz	7,59 €	8,43 €	1	50

Lama Puk Pz 12 PUK



Codice	Riferimenti	Listino A	Listino B	Off.	Box
PUK	12	3,41 €	3,78 €	1	50
PUKx144	144	3,24 €	3,59 €	1	50

Doppio metro in legno 9367956



Codice	Riferimenti	Listino A	Listino B	Off.	Box
9367956	mm 200	3,69 €	4,09 €	1	50

Doppio metro in plastica 9367957



Codice	Riferimenti	Listino A	Listino B	Off.	Box
9367957	mm 200	2,71 €	3,01 €	1	50

Giravite A Bussola 8 Mm



Codice	Riferimenti	Listino A	Listino B	Off.	Box
629CR8	8 mm	8,75 €	9,72 €	1	12
629CR10	10 mm	9,18 €	10,19 €	1	12



Chiave combinata stella e fissa

Codice	Riferimenti	Listino A	Listino B	Off.	Box
31720	mm. 6	0,73 €	0,81 €	1	10
31721	mm. 7	0,81 €	0,90 €	1	10
31722	mm. 8	0,91 €	1,01 €	1	10
31723	mm. 9	0,99 €	1,10 €	1	10
31724	mm. 10	1,04 €	1,15 €	1	10
31725	mm. 11	1,09 €	1,21 €	1	10
31726	mm. 12	1,14 €	1,26 €	1	10
31727	mm. 13	1,27 €	1,40 €	1	10
31728	mm. 14	1,32 €	1,46 €	1	10
31729	mm. 15	1,59 €	1,77 €	1	10
31730	mm. 16	1,72 €	1,91 €	1	10
31731	mm. 17	1,77 €	1,97 €	1	10
31732	mm. 18	1,82 €	2,02 €	1	10
31733	mm. 19	2,05 €	2,27 €	1	10
31734	mm. 20	2,28 €	2,53 €	1	10
31735	mm. 21	2,50 €	2,78 €	1	10
31736	mm. 22	2,63 €	2,92 €	1	10
31737	mm. 23	2,86 €	3,17 €	1	10
31738	mm. 24	2,96 €	3,29 €	1	10
31739	mm. 25	3,19 €	3,54 €	1	10
31740	mm. 26	3,42 €	3,79 €	1	10
31741	mm. 27	3,64 €	4,04 €	1	10
31742	mm. 28	4,00 €	4,44 €	1	10
31743	mm. 29	4,55 €	5,06 €	1	10
31744	mm. 30	6,27 €	6,97 €	1	10



Chiave combinata fissa

Codice	Riferimenti	Listino A	Listino B	Off.	Box
31700	6x7	1,04 €	1,15 €	1	10
31701	8x9	1,14 €	1,26 €	1	10
31702	10x11	1,27 €	1,40 €	1	10
31703	12x13	1,37 €	1,52 €	1	10
31704	14x15	1,49 €	1,66 €	1	10
31705	16x17	1,95 €	2,16 €	1	10
31706	18x19	2,28 €	2,53 €	1	10
31707	20x22	2,50 €	2,78 €	1	10
31708	21x23	3,64 €	4,04 €	1	10
31709	24x26	3,97 €	4,41 €	1	10
31710	24x27	4,10 €	4,55 €	1	10
31711	25x28	4,20 €	4,66 €	1	10
31712	27x32	5,14 €	5,70 €	1	10
31713	30x32	5,69 €	6,32 €	1	10

Chiave Scaldabagno A
Tubo 55X55 1181

Codice	Riferimenti	Listino A	Listino B	Off.	Box
1181	55	7,49 €	8,31 €	1	50

Chiave Bombola Da 25
CB25

Economy

Codice	Riferimenti	Listino A	Listino B	Off.	Box
CB25	25 mm	1,67 €	1,85 €	1	10

Chiave Bombola Da 25
8100000

Codice	Riferimenti	Listino A	Listino B	Off.	Box
8100000		4,91 €	5,45 €	1	10

Chiave Crescente Cromata
Mm. 200 1015A

Codice	Riferimenti	Listino A	Listino B	Off.	Box
1015A	MM. 200	4,25 €	4,72 €	1	50

Chiave Crescente Cromata
Mm. 250 1015B

Codice	Riferimenti	Listino A	Listino B	Off.	Box
1015B	MM. 250	9,45 €	10,48 €	1	50
1015B	MM. 300	9,45 €	10,48 €	1	50

CASSETTE WC FLACONE
DA 1000 m. Cod. 0005038

Codice	Riferimenti	Listino A	Listino B	Off.	Box
0005038		4,68 €	4,68 €	1	10

SMQ Sbavatore Multistrato
Universo SMQCalibratore Svasatore Con
Lame Per Tubo Multistrato D.
16-20-26 Mm DCAL1626P

Codice	Riferimenti	Listino A	Listino B	Off.	Box
SMQ	16-20	3,64 €	4,04 €	1	10
DCAL1626P	16-20-26	9,79 €	10,87 €	1	10

Pinza Poligrip regolabile



Codice	Riferimenti	Listino A	Listino B	Off.	Box
R-PP7	07"	8,26 €	9,16 €	1	10
R-PP10	10"	12,65 €	14,04 €	1	10
R-PP12	12"	9,11 €	10,11 €	1	10

Giratubo Da 1"90° Expo G1E90



Codice	Riferimenti	Listino A	Listino B	Off.	Box
G1E90	1" 90°	9,11 €	10,11 €	1	10
G11\2E90	1 1/2" 90°	26,87 €	29,83 €	1	10
G2E90	2" 90°	31,20 €	34,63 €	1	10

Sgomberatubo in filo d'acciaio con manovella a spirale 8 mm

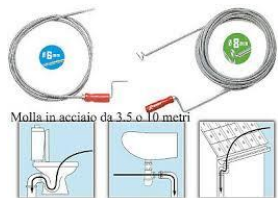

Molla in acciaio da 3.5 o 10 metri

SGORGRAPID
Disotturante per scarichi

Codice	Riferimenti	Listino A	Listino B	Off.	Box
STMS801	150 mm	1,85 €	2,05 €	1	10
STMS802	250 mm	2,45 €	2,72 €	1	10
STMS803	300 mm	2,96 €	3,29 €	1	10
STMS804	350 mm	7,59 €	8,43 €	1	10
STMS805	400 mm	3,77 €	4,18 €	1	10
STMS806	500 mm	7,59 €	8,43 €	1	10

Giratubo Professional 45° D. 1/2" GE1\245



Codice	Riferimenti	Listino A	Listino B	Off.	Box
GE1\245	1/2" 45°	20,57 €	22,83 €	1	10
GE145	1" 45°	18,72 €	20,78 €	1	10
GE11\245	1 1/2" 45°	28,70 €	31,86 €	1	10
GE245	2" 45°	50,48 €	56,03 €	1	10
GE345	3" 45°	77,04 €	85,52 €	1	10



Tagliatubo Rottenberger 2" R-T2

Codice	Rif.	Listino A	Listino B
R-T2	1	85,51 €	94,92 €



R-T30 Tagliatubo Rame 30 C.302070019 R-T30



R-T50 Tagliatubo Rame 50 C.302070065 R-T50

Codice	Rif.	Listino A	Listino B
R-T30	D. 30	16,65 €	18,48 €
R-T50	D. 50	23,34 €	25,91 €



PC301 Cesويا Per Tubi Di Plastica 0/42 Mm PC301



PC309 Cesويا 0/42 Mm PC309

Codice	Rif.	Listino A	Listino B
PC301	1	7,97 €	8,85 €
PC309	1	15,68 €	17,40 €



PC306 Cesويا 0/36 Mm PC306

Codice	Rif.	Listino A	Listino B
PC306	1	27,32 €	30,32 €



PC305 Cesويا 0/42 Mm PC305

Codice	Rif.	Listino A	Listino B
PC305	1	36,25 €	40,24 €



R-T16 Minicutter Suer Ego 1/8 5/8 3-16Mm Mc22 R-T16

Codice	Rif.	Listino A	Listino B
R-T16	3<>16	6,84 €	7,59 €



PC63 Cesويا 0/63 Mm PC63

Codice	Rif.	Listino A	Listino B
PC63	1	69,71 €	77,38 €



0004062 DETERGENTE CONDIZIONATORI BOMBOLA DA 400 ml Cod. 0004062

Codice	Rif.	Listino A	Listino B
0004062	1	4,50 €	5,00 €



0004642 PULITORE CONDIZIONATORI SCHIUMOGENO BOMBOLA DA 400 ml C/CANN. Cod. 0004642

Codice	Rif.	Listino A	Listino B
0004642	1	5,19 €	5,76 €



DPAC02 Disotturatore Aria Compresso Tipo Pango DPAC02

Codice	Rif.	Listino A	Listino B
DPAC02	1	20,04 €	22,24 €



79469 Stura Lavandino a Pompa Con Ventosa Per Tubi Lavello Lavandini WC Bagno 79469

Codice	Rif.	Listino A	Listino B
79469	1	6,07 €	6,74 €



MELT Disorgante Liquido Melt X 750 MI 708001ITSP



Quando viene utilizzato il prodotto, la cosa più importante è avere un'adeguata ventilazione e protezione. Evitare di inalare il prodotto. Non ingerire il prodotto. Evitare di entrare in contatto con gli occhi. SENZA Alcol e senza pericoli all'acqua calda.

Codice	Rif.	Listino A	Listino B
708001ITSP	1	5,23 €	5,80 €



430 SILCOFLEX
TRASPARENTE
CARTUCCIA 280 ML
SILICONE Cod. TSTP



430 SILCOFLEX BIANCO
CARTUCCIA 280 ML
SILICONE Cod. TSBP



ECO SILIC.
SIGILLANTE*50 ml*
BIANCO TUBETTO IN
BLISTER Cod. 0001920

Codice	Rif.	Listino A	Listino B	Codice	Rif.	Listino A	Listino B	Codice	Rif.	Listino A	Listino B
TSTP	1	3,40 €	3,78 €	TSBP	1	3,52 €	3,91 €	TSBB	1	2,58 €	2,86 €
TSTPX30	30	3,26 €	3,62 €	TSBPX30	30	3,38 €	3,75 €	TSBT	1	2,58 €	2,86 €



SIMP FIX CARTUCCIA
TRASPARENTE
Cristallino CARTUCCIA
da 290 Cod. 0006073



FORZA 10 SIL
SIGILLANTE BIANCO
CARTUCCIA 280 ML
Cod. 0006466



LINEA FUOCO 1500
GRIGIO SCURO
CARTUCCIA DA 580 gr.E
Cod. 0006200

Codice	Rif.	Listino A	Listino B	Codice	Rif.	Listino A	Listino B	Codice	Rif.	Listino A	Listino B
0006073	1	11,51 €	12,78 €	0006466	1	5,69 €	6,32 €	0006200	1	Arrivo	Arrivo



SIGILL GITANG
PLUS TUBETTO IN
ASTUCCIO 125 gr.
0002036



#N/D



SILCOFLEX 583
TERMORESISTENTE
NERO SILICONE
CARTUCCIA DA 300
Cod. 0006222

Codice	Rif.	Listino A	Listino B	Codice	Rif.	Listino A	Listino B	Codice	Rif.	Listino A	Listino B
0002036	1	4,43 €	4,92 €	0006487	1	Arrivo	Arrivo	0006222	1	7,08 €	7,86 €



LEVASIL SPRAY
RIMUOVI SILICONE
BOMBOLA 400 ml Cod.
0004325



SIGILL NASTRO
AUTOAGGLOMERANTE
ROTOLO IN BLISTER
25mm x 3m Cod.
0001681



Strip sezione piatta
grigis 10x3 (su 6 file in
bobine da mt. 25 = 150
mt totale) prezzo al mt.
Cod. 0003034

Codice	Rif.	Listino A	Listino B	Codice	Rif.	Listino A	Listino B	Codice	Rif.	Listino A	Listino B
0004325	1	6,63 €	7,36 €	0001681	1	5,69 €	6,32 €	0003034	1	9,11 €	10,11 €



BLOCK IDRALICA GAS
METANO 60 ML IN
FLACONE Cod. 0005102



MUFFA KILLER 750ML
IN ASTUCCIO
C/SPRUZZATORE



SIGILL MUFFA KILLER
250 ML FLACONE
C/SPRUZZATORE Cod.
0005030

Codice	Rif.	Listino A	Listino B	Codice	Rif.	Listino A	Listino B	Codice	Rif.	Listino A	Listino B
0005102	1	9,87 €	10,95 €	0005028	1	7,34 €	8,15 €	0005030	1	4,55 €	5,06 €



SIGILL STRIP BAND
STUCCO PIATTINA
ROTOLO IN BLISTER da
mm10x Cod. 0001520



Strip sezione piatta
grigis 10x3 (su 6 file in
bobine da mt. 25 = 150
mt totale) prezzo al mt.
Cod. 0051005



COLOR VERNICE
TRACCIANTE PROFESS.
ROSSO FLUO-
BOMBOLA 500 ml Cod.
0004086

Codice	Rif.	Listino A	Listino B	Codice	Rif.	Listino A	Listino B	Codice	Rif.	Listino A	Listino B
0001520	1	5,69 €	6,32 €	0051005	1	0,61 €	0,67 €	0004086	1	7,34 €	8,15 €



Batavia 7062507 18 V Agli Ioni Di Litio Per Segna A Gattuccio, 36 W 18V LI-ION SEGA ALTERNATIVA 0-3000 SPM LUNGHEZZA DEL TRATTO 22MM SOLO STRUMENTO



FORBICI A BATTERIA BATAVIA 3,6V - Incl. Teste Di Taglio 7047996



COMPRESSORE D'ARIA 18V, Colore: Grigio/Arancione 7063487

Codice	Pz	Listino A	Listino B
7062507	1	104,85 €	116,38 €

Codice	Pz	Listino A	Listino B
7047996	1	42,59 €	47,28 €

Codice	Pz	Listino A	Listino B
7063487	1	92,51 €	102,69 €



Batavia 18V Batteria Utensile Multifunzione 7062510 Senza Caricabatteria 7062510



DECESPUGLIATORE 18 V AGLI IONI DI LITIO BATAVIA 7062516



Sega Circolare A Batteria 18V Maxxpack 7062508

Codice	Pz	Listino A	Listino B
7062510	1	60,86 €	67,56 €

Codice	Pz	Listino A	Listino B
7062516	1	84,52 €	93,82 €

Codice	Pz	Listino A	Listino B
7062508	1	109,56 €	121,61 €



Batavia Bat7062511 Maxxpack 2 Modalità Trapano Sds 18V Nudo Unità 7062511



Jig Saw Seghetto Alternativo Bat 7062513



Idropulitrice A Batteria, 24 Bar, Senza Batteria/Caricabatterie 7063576

Codice	Pz	Listino A	Listino B
7062511	1	134,11 €	148,86 €

Codice	Pz	Listino A	Listino B
7062513	1	67,88 €	75,35 €

Codice	Pz	Listino A	Listino B
7063576	1	121,73 €	135,12 €



Motosega Compatta Batavia 7063825



Motosega Compatta Batavia Completo Di Batteria E Copribatteria 7063824



Scala Telescopica Giraffe Air 3.27M | Con Softclose & Antiscivolo 7063596

Codice	Pz	Listino A	Listino B
7063825	1	121,73 €	135,12 €

Codice	Pz	Listino A	Listino B
7063824	1	199,00 €	220,89 €

Codice	Pz	Listino A	Listino B
7063596	1	219,11 €	243,21 €



Trapano Combinato Con Motore Senza Spazzole Batavia 7062722



Pompa Da Giardino 1500 L/H 11 M - Batavia 7063549



COMPRESSORE D'ARIA 18V, Colore: Grigio/Arancione 7063487

Codice	Pz	Listino A	Listino B
7062722	1	219,13 €	243,24 €

Codice	Pz	Listino A	Listino B
7063549	1	109,49 €	121,53 €

Codice	Pz	Listino A	Listino B
7063487	1	92,51 €	102,69 €



BATTERIA AGLI IONI DI LITIO 36W 18V 4 AH 7062518



Giraffe Air Telescoopladder 2,63M 7063650 Batavia 7063650



Scala Telescopica In Alluminio, Altezza Di Lavoro (Max): 4,6 M, 3 Colori, 15,3 Kg 7063088

Codice	Pz	Listino A	Listino B
7062518	1	77,46 €	85,98 €

Codice	Pz	Listino A	Listino B
7063650	1	170,43 €	189,18 €

Codice	Pz	Listino A	Listino B
7063088	1	304,34 €	337,82 €



SCALA A SFILLO IN ACCIAIO GR. 4+4 PRATIC4+4ACC



SCALA A SFILLO IN ACCIAIO GR. 4+5 PRATIC4+5ACC



SCALA A SFILLO IN ACCIAIO GR. 5+5 PRATIC5+5ACC

Codice	Pz	Listino A	Listino B
PRATIC4+4ACC	1	112,81 €	125,22 €

Codice	Pz	Listino A	Listino B
PRATIC4+5ACC	1	127,38 €	141,39 €

Codice	Pz	Listino A	Listino B
PRATIC5+5ACC	1	143,28 €	159,04 €



	SCALA LIBELLULA 4 GRADINI S107A04W		SCALA LIBELLULA 5 GRADINI S107A05W		SCALA LIBELLULA 6 GRADINI S107A06W						
Codice	Pz	Listino A	Listino B	Codice	Pz	Listino A	Listino B	Codice	Pz	Listino A	Listino B
S107A04W	1	60,76 €	67,45 €	S107A05W	1	71,94 €	79,85 €	S107A06W	1	84,07 €	93,32 €
	SCALA LIBELLULA 7 GRADINI S107A07W		SCALA LIBELLULA 8 GRADINI S107A08W		SGABELLO STABILO 2 GRADINI G120L02W						
Codice	Pz	Listino A	Listino B	Codice	Pz	Listino A	Listino B	Codice	Pz	Listino A	Listino B
S107A07W	1	105,40 €	116,99 €	S107A08W	1	120,88 €	134,17 €	G120L02W	1	31,79 €	35,28 €
	Cazzuola Pt 18 Progrip 123601		Cazzuolino Foglio Olivo Cm.14 123473		SGABELLO STABILO 3 GRADINI G120L03W						
Codice	Pz	Listino A	Listino B	Codice	Pz	Listino A	Listino B	Codice	Pz	Listino A	Listino B
123601	1	8,32 €	9,24 €	123473	1	4,53 €	5,03 €	G120L03W	1	41,73 €	46,32 €
	Cazzuola P.T. 19.1 Ghiera 123341		Cazzuolino Foglio Ulivo Cm.14 Expo 3062A		Martellina Catania Gr.400 110820						
Codice	Pz	Listino A	Listino B	Codice	Pz	Listino A	Listino B	Codice	Pz	Listino A	Listino B
123341	1	7,51 €	8,34 €	3062A	1	2,83 €	3,15 €	110820	1	7,29 €	8,09 €
	Metro Avvolgibile Mt. 2 748082		Martello Carpentiere Gr. 300 In Fibra Expo 3004B		Martello Carpentiere Gr. 300 Faggio Expo 3004A						
Codice	Pz	Listino A	Listino B	Codice	Pz	Listino A	Listino B	Codice	Pz	Listino A	Listino B
748082	1	0,86 €	0,95 €	3004B	1	8,10 €	8,99 €	3004A	1	5,47 €	6,07 €
	Mazzetta Club C/M Gr. 1000 10145		Mazzetta Master Gr.1000 Progrip 10143		Set 5 Giraviti Unior - 4,01 5,5X1,25 6,5X 150 + 1X80 609CS5BI						
Codice	Pz	Listino A	Listino B	Codice	Pz	Listino A	Listino B	Codice	Pz	Listino A	Listino B
10145	1	12,71 €	14,10 €	10143	1	15,26 €	16,94 €	609CS5BI	1	17,43 €	19,35 €
	Imbuto Flessibile Con Filtro 749103		Tubo Per Travaso 749104		Pinza Manici Super Grip Da 200 406BI						
Codice	Pz	Listino A	Listino B	Codice	Pz	Listino A	Listino B	Codice	Pz	Listino A	Listino B
749103	1	1,37 €	1,52 €	749104	1	1,24 €	1,38 €	406BI	1	10,36 €	11,50 €



Forno Casetta 81X103 Sp.Lat. Kg. 6 X Uso Domestico HS210



Codice	Riferimenti	Listino A	Listino B	Conf.	Box
HS210		1181,35 €	1181,35 €	1	10

Campingaz Barbecue Carbone BONESCO



Large Nero

Barbecue Campingaz Bonesco Qst L Carrello Antracite Nero 3000001554



Codice	Riferimenti	Listino A	Listino B	Conf.	Box
3000001554		269,36 €	298,99 €	1	10



CAMPINGAZ Barbecue a Gas Piastra in Ghisa da Esterno BBQ da Giardino con Ripiani laterali Ruote e Vano portabombola - 3000004975 Adelaide 3 Woody 203431



Codice	Riferimenti	Listino A	Listino B	Conf.	Box
203431		295,52 €	328,03 €	1	10



Barbecue A Carbonella Ferraboli Pic Nic 28 Cm 0000208

Codice	Riferimenti	Listino A	Listino B	Conf.	Box
0000208		31,37 €	34,82 €	1	10



Powerbox 24 Cl-A Te Cooler 68679



Codice	Riferimenti	Listino A	Listino B	Conf.	Box
68679		86,21 €	95,69 €	1	10



Lume A Gas Camping 206 L 2000010189

Codice	Riferimenti	Listino A	Listino B	Conf.	Box
2000010189		27,07 €	30,05 €	1	10



Cartuccia Cp 250 Nuovo Cod.2000022384 Cod. 2000034449 202208

Codice	Riferimenti	Listino A	Listino B	Conf.	Box
202208		3,99 €	4,43 €	1	10



Forno Retto 81X103 Spor.Lat. Kg. 6 X Uso Domestico HS100



Codice	Riferimenti	Listino A	Listino B	Conf.	Box
HS100		1181,35 €	1181,35 €	1	10



Barbecue Campingaz Bonesco Lc Kettle Antracite Nero, Grigio 3000001552



Codice	Riferimenti	Listino A	Listino B	Conf.	Box
3000001552		162,33 €	180,19 €	1	10



Barbecue Compatto A Gas Con Due Bruciatori 3000002865



Codice	Riferimenti	Listino A	Listino B	Conf.	Box
3000002865		126,27 €	140,16 €	1	10



Ferraboli Ledro Grill Carrello Antracite Nero 65 X 48 X 84 0000149

Codice	Riferimenti	Listino A	Listino B	Conf.	Box
0000149		55,77 €	61,90 €	1	10



Barbecue a carbonella 30 X 45 con base/ruote e appoggio 1068

Codice	Riferimenti	Listino A	Listino B	Conf.	Box
1068		65,06 €	72,22 €	1	10



Cannello Brevettato corpo plastica con piezo CPEH

Codice	Riferimenti	Listino A	Listino B	Conf.	Box
CPEH		16,90 €	18,76 €	1	10



Cv 300 Plus - Cartuccia 3000005010 203427

Codice	Riferimenti	Listino A	Listino B	Conf.	Box
203427		6,77 €	7,51 €	1	10



Set 10 Fascette Per Tubi 770308

2x8 -18mm
2x11-20mm
2x13-23mm
2x18-25mm
2x14-27mm

Codice	Riferimenti	Listino A	Listino B	Conf.	Box
770308		1,24 €	1,37 €	1	10



Cartuccia Gas Da 190 Gr. CG190

Codice	Riferimenti	Listino A	Listino B	Conf.	Box
CG190		1,71 €	1,90 €	1	10



Set 6 Fascette Per Tubi 748310

Codice	Riferimenti	Listino A	Listino B	Conf.	Box
748310		0,91 €	1,01 €	1	10



Chiave Bombola Da 25 CB25

Codice	Riferimenti	Listino A	Listino B	Conf.	Box
CB25		1,67 €	1,85 €	1	10



Fornellone Piccolo 792600

bruciatore da 12,5cm
30x30cm

Codice	Riferimenti	Listino A	Listino B	Conf.	Box
792600		22,25 €	24,70 €	1	10



Fornellone Grande 792601

bruciatore da 17,5cm
40x40CM

Codice	Riferimenti	Listino A	Listino B	Conf.	Box
792601		29,67 €	32,94 €	1	10



Fornellone Cm 30X30X13 Con Bruciatore In Ghisa Kw 3,5 Omologato Ce 600CE



Codice	Riferimenti	Listino A	Listino B	Conf.	Box
600CE		29,64 €	32,90 €	1	10



Fornellone Cm 40X40X19 Con Bruciatore In Ghisa Kw 8,5 Omologato Ce 230CE



Codice	Riferimenti	Listino A	Listino B	Conf.	Box
230CE		41,66 €	46,24 €	1	10



Bruciatore 3 Bracci Orientabili 3342500

Codice	Riferimenti	Listino A	Listino B	Conf.	Box
33425001		12,12 €	13,45 €	1	10



Fornello Cm 30X30X13 Con Telaio, Viteria E Regolatore Aria In Acciaio Inox Aisi 430. Bruciatore In Ghisa Kw 3,5. Omologato Ce. 650CE

Codice	Riferimenti	Listino A	Listino B	Conf.	Box
650CE		34,72 €	38,54 €	1	10



Giunto Riparatore 1/2"-5 /8 3332001

Codice	Riferimenti	Listino A	Listino B	Conf.	Box
3332001		2,73 €	3,03 €	1	10



Fornellone "Mammoth" Cm. 38 X 38 X 19H Fornellone Pesante Con Bruciatore In Ghisa Da Kw 8,5. Omologato Ce. 150CE

Codice	Riferimenti	Listino A	Listino B	Conf.	Box
150CE		51,07 €	56,68 €	1	10



Giunto Riparatore 5 /8-3/4" 33325001

Codice	Riferimenti	Listino A	Listino B	Conf.	Box
33325001		3,19 €	3,54 €	1	10



Giunto Ripar. Uni.1/2"-5 /8-3/4" 33330001

Codice	Riferimenti	Listino A	Listino B	Conf.	Box
33330001		4,00 €	4,44 €	1	10



Ala Gocciolante Ø16Mm 2 Lt/H
30Cm 100M 431160230100

Codice	Riferimenti	Listino A	Listino B	Conf.	Box
431160230100		0,42 €	0,47 €	1	10



Gomito Per Ala Con Anellino Ø
16 9980016000

Codice	Riferimenti	Listino A	Listino B	Conf.	Box
9980016000		0,51 €	0,57 €	1	10



Manicotto Ala MAALA

Codice	Riferimenti	Listino A	Listino B	Conf.	Box
MAALA		0,49 €	0,55 €	1	10



Raccordo Maschio Per Ala Con
Anellino Ø 16X1/2 991401600B

Codice	Riferimenti	Listino A	Listino B	Conf.	Box
991401600B		0,36 €	0,40 €	1	10



Raccordo Maschio Per Ala Con
Anellino Ø 16X3/4 991401600C

Codice	Riferimenti	Listino A	Listino B	Conf.	Box
991401600C		0,36 €	0,40 €	1	10



Tee Per Ala Con Anellino Ø 16
9950016000

Codice	Riferimenti	Listino A	Listino B	Conf.	Box
9950016000		0,61 €	0,68 €	1	10



Raccordo Per Tubi 1/2" 515235

Codice	Riferimenti	Listino A	Listino B	Conf.	Box
515235		0,66 €	0,73 €	1	10



Lancia Erogatrice 770360

Codice	Riferimenti	Listino A	Listino B	Conf.	Box
770360		1,29 €	1,44 €	1	10



Lancia Erogatrice 770283

Codice	Riferimenti	Listino A	Listino B	Conf.	Box
770283		1,68 €	1,87 €	1	10



Pistola Da Giardino 9 Getti
538210

Codice	Riferimenti	Listino A	Listino B	Conf.	Box
538210		8,94 €	9,93 €	1	10



Pistola Erogatore Per Tubo Da
770281

Codice	Riferimenti	Listino A	Listino B	Conf.	Box
770281		3,63 €	4,02 €	1	10



Pistola Erogatore Per Tubo Da
770282

Codice	Riferimenti	Listino A	Listino B	Conf.	Box
770282		4,15 €	4,61 €	1	10



Pistola Erogatrice 770358

Codice	Riferimenti	Listino A	Listino B	Conf.	Box
770358		9,78 €	10,85 €	1	10



Raccordo Per Tubi 3/4" 515236

Codice	Riferimenti	Listino A	Listino B	Conf.	Box
515236		0,91 €	1,01 €	1	10



Raccordo 1/2"-5 /8 Fermo Sicu.
33305001

Codice	Riferimenti	Listino A	Listino B	Conf.	Box
33305001		4,91 €	5,45 €	1	10



Raccordo 1/2"-5 /8-3/4" Fermo
33315001

Codice	Riferimenti	Listino A	Listino B	Conf.	Box
33315001		4,55 €	5,06 €	1	10



Raccordo 5 /8-3/4" Fermo Sic.
33310001

Codice	Riferimenti	Listino A	Listino B	Conf.	Box
33310001		4,38 €	4,86 €	1	10



Tubo Garden 6 Strati 3/4" Mt.
25 33040001

Codice	Riferimenti	Listino A	Listino B	Conf.	Box
33040001		67,56 €	74,99 €	1	10



Avvolgitubo C/Stand 538206

Codice	Riferimenti	Listino A	Listino B	Conf.	Box
538206		31,43 €	34,88 €	1	10



Tubo Garden 6Strati 1/2" Mt. 15
33010001

Codice	Riferimenti	Listino A	Listino B	Conf.	Box
33010001		20,57 €	22,83 €	1	10



Doccia Da Giardino C/Base 2,25
Mt 538201

Codice	Riferimenti	Listino A	Listino B	Conf.	Box
538201		20,67 €	22,95 €	1	10



Tubo Garden 6Strati 1/2" Mt. 25
33015001

Codice	Riferimenti	Listino A	Listino B	Conf.	Box
33015001		34,33 €	38,11 €	1	10



Irrigatore Multifunzione 770316

Codice	Riferimenti	Listino A	Listino B	Conf.	Box
770316		4,83 €	5,36 €	1	10



Irrigatore Rotante 770315

Codice	Riferimenti	Listino A	Listino B	Conf.	Box
770315		4,20 €	4,66 €	1	10



Irrigatore X Giardino A Settore
516892

Codice	Riferimenti	Listino A	Listino B	Conf.	Box
516892		5,69 €	6,32 €	1	10



Irrigatore X Giardino A Settore
516890

Codice	Riferimenti	Listino A	Listino B	Conf.	Box
516890		3,96 €	4,40 €	1	10



Irrigatore X Giardino Rot.
516891

Codice	Riferimenti	Listino A	Listino B	Conf.	Box
516891		2,86 €	3,17 €	1	10



Lancia C/Getto Regolabile
770363

Codice	Riferimenti	Listino A	Listino B	Conf.	Box
770363		7,64 €	8,48 €	1	10

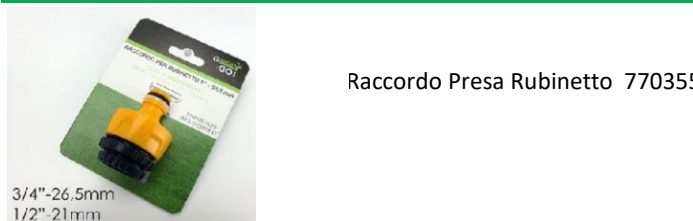

Raccordo Presa Rubinetto 770355

Codice	Riferimenti	Listino A	Listino B	Conf.	Box
770355		1,24 €	1,37 €	1	10



Raccordo Presa Rubinetto 770357

Codice	Riferimenti	Listino A	Listino B	Conf.	Box
770357		3,39 €	3,76 €	1	10



Raccordo Presa Rubinetto 2 Vie
515238

Codice	Riferimenti	Listino A	Listino B	Conf.	Box
515238		0,96 €	1,07 €	1	10



Raccordo Rapido 770354

Codice	Riferimenti	Listino A	Listino B	Conf.	Box
770354		1,24 €	1,37 €	1	10



Raccordo Rapido A Innesto 1/2"
515237

Codice	Riferimenti	Listino A	Listino B	Conf.	Box
515237		1,24 €	1,38 €	1	10



Raccordo Rapido Acqua Stop 770354A

Codice	Riferimenti	Listino A	Listino B	Conf.	Box
770354A		1,24 €	1,37 €	1	10



Raccordo Rapido Acqua Stop
1/2" 515237A

Codice	Riferimenti	Listino A	Listino B	Conf.	Box
515237A		1,24 €	1,38 €	1	10



Raccordo Rubinetto 3/4" - 1/2"
515234

Codice	Riferimenti	Listino A	Listino B	Conf.	Box
515234		1,11 €	1,24 €	1	10



Seghetto C/2 Lama 16 Cm 770147

Codice	Riferimenti	Listino A	Listino B	Conf.	Box
770147		5,53 €	6,14 €	1	10



Set 3 Pz Giardinaggio 747849

Codice	Riferimenti	Listino A	Listino B	Conf.	Box
747849		2,04 €	2,27 €	1	10

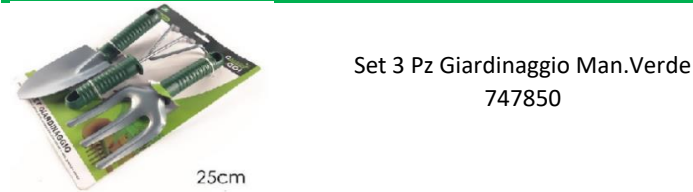

Set 3 Pz Giardinaggio Man.Verde
747850

Codice	Riferimenti	Listino A	Listino B	Conf.	Box
747850		2,04 €	2,27 €	1	10



Set 3 Raccordi C/Erogatore Per
770280

Codice	Riferimenti	Listino A	Listino B	Conf.	Box
770280		2,73 €	3,03 €	1	10

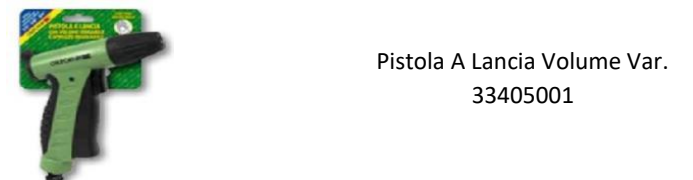

Pistola A Lancia Volume Var.
33405001

Codice	Riferimenti	Listino A	Listino B	Conf.	Box
33405001		14,25 €	15,81 €	1	10



Racc.5/8-3/4 Fermo Acqua Stop
33310102

Codice	Riferimenti	Listino A	Listino B	Conf.	Box
33310102		5,67 €	6,29 €	1	10



unto Riparatore 5 /8-3/4" 3332500

Codice	Riferimenti	Listino A	Listino B	Conf.	Box
33325001		3,19 €	3,54 €	1	10



irrigatore 360°Turbina Slit. 3343000

Codice	Riferimenti	Listino A	Listino B	Conf.	Box
33430001		27,05 €	30,02 €	1	10



Irrigatore 9 Figure C/Pop Up
33420001

Codice	Riferimenti	Listino A	Listino B	Conf.	Box
33420001		17,76 €	19,72 €	1	10



Tubo Estensibile 15 Mt C/Pistola
7 538219

Codice	Riferimenti	Listino A	Listino B	Conf.	Box
538219		24,76 €	27,48 €	1	10



bo Giallo 20 Mt Da Giardino 8058

Codice	Riferimenti	Listino A	Listino B	Conf.	Box
805800	10 mt	8,17 €	9,07 €	1	10
805801	15 mt	10,91 €	12,10 €	1	10
805802	20 mt	14,60 €	16,21 €	1	10



tubo 10 Mt C/Pistola + Acc. 69291

Tubo 15 Mt C/Pistola + Acc.
692907

Tubo 20 Mt C/Pistola+Acc.
692905

Tubo 30 Mt C/Pistola + Acc.
692906

Codice	Riferimenti	Listino A	Listino B	Conf.	Box
692910	10 mt	8,55 €	9,49 €	1	10
692907	15 mt	13,36 €	14,83 €	1	10
692905	20 mt	17,08 €	18,96 €	1	10
692906	25 mt	22,04 €	24,46 €	1	10



irrigatore 360°Turbina Fisso 334350

Codice	Riferimenti	Listino A	Listino B	Conf.	Box
33435001		21,08 €	23,39 €	1	10



Irrigatore 8 Figure 33415001

Codice	Riferimenti	Listino A	Listino B	Conf.	Box
33415001		9,67 €	10,73 €	1	10



Lancia C/Spruo Regolabile Zx
33400001

Codice	Riferimenti	Listino A	Listino B	Conf.	Box
33400001		6,71 €	7,44 €	1	10



Tubo Antigelo 14x19 mm rotolo
130 Prezzo al Kg. ogni metro
pesa circa 0,18 kg TA14X19

Tubo Antigelo 18X24 mm
rotolo 100 Prezzo al Kg. ogni
metro pesa circa 0,23 kg

Codice	Riferimenti	Listino A	Listino B	Conf.	Box
TA14X19		5,44 €	6,04 €	1	10
TA18X24		5,44 €	6,04 €	1	10



Fascetta Stringitubo 14<>18
Prezzo confezione pz. 100 banda
9 mm FS14-18

Fascetta Stringitubo 20<>32
Prezzo confezione pz. 100 banda
9 mm FS20-32

Codice	Riferimenti	Listino A	Listino B	Conf.	Box
FS14-18	Arrivo	Arrivo	Arrivo	1	10
FS20-32	Arrivo	Arrivo	Arrivo	1	10

Ardes Stufa Quarzo
800W AR435B

Ardes
Aria di casa

Codice	Pz	Listino A	Listino B
AR435B	1	15,57 €	17,28 €



Ardes
Termoventilatore
Baleno Swing
Doppia Potenza
1000/2000W

Ardes
Aria di casa

Codice	Pz	Listino A	Listino B
AR4F03	1	31,39 €	34,85 €



Ardes
Termoventilatore
Caldobagno Ip21
AR4F06T

Codice	Pz	Listino A	Listino B
AR4F06T	1	53,63 €	59,53 €



Ardes Tikappa
Scaldaletto
Matrimoniale 2
Temperatura
160X140 AR4U140

Codice	Pz	Listino A	Listino B
AR4U140	1	52,91 €	58,73 €



Scaldaletto Singolo
150X80Cm
AR4U80

Codice	Pz	Listino A	Listino B
AR4U80	1	31,26 €	34,70 €



Ardes
Termoventilatore
Ceramico 1500 W
Ar4P07W
AR4P07A

Codice	Pz	Listino A	Listino B
AR4P07A	1	26,81 €	29,76 €



Scaldaletto
Matrimoniale
Misto Lana
150X160Cm

Ardes
Aria di casa

Codice	Pz	Listino A	Listino B
AR423	1	92,60 €	102,78 €



Scaldaletto Singolo
Misto Lana
150X80Cm AR412

Ardes
Aria di casa

Codice	Pz	Listino A	Listino B
AR412	1	55,31 €	61,40 €



Radiatore 9
Elementi
"Kompact"
Compatto S719

Codice	Pz	Listino A	Listino B
S719	1	28,35 €	31,47 €



Scaldapiedi Con
Rivestimento
Removibile
AR4H05

Ardes
Aria di casa

Codice	Pz	Listino A	Listino B
AR4H05	1	52,39 €	58,16 €



Sole Mio Scaldino
Elettrico 550W Con
Lampada Spia,
Bronzo AR71

Ardes
Aria di casa

Codice	Pz	Listino A	Listino B
AR71	1	31,39 €	34,85 €



Qlima
HOME MADE CLIMATES

Stufa a fungo per
esterni bianca
PGU2013W

Codice	Pz	Listino A	Listino B
PGU2013W	1	276,98 €	307,45 €



Stufa a gas 4.2 kW
Grigia GH3042R

Qlima
HOME MADE CLIMATES

Codice	Pz	Listino A	Listino B
GH3042R	1	191,00 €	212,01 €



Stufa a gas 4.2 kW
Nera GH1142R

Qlima
HOME MADE CLIMATES

Codice	Pz	Listino A	Listino B
GH1142R	1	130,38 €	144,72 €



Qlima
HOME MADE CLIMATES

Stufa a fungo per
esterni nera
PGU2013B

Codice	Pz	Listino A	Listino B
PGU2013B	1	276,98 €	307,45 €



Stufa Al Quarzo 2
Elementi 800W
QZ800

Codice	Pz	Listino A	Listino B
QZ800	1	11,62 €	12,90 €



Stufa Alogena Con
3 Elementi
Riscaldanti, Nera
AR454B

Ardes
Aria di casa

Codice	Pz	Listino A	Listino B
AR454B	1	30,85 €	34,25 €



Stufa Elettrica
Alogena Al Quarzo
Potenza 800 Watt
M02543

Codice	Pz	Listino A	Listino B
M02543	1	10,82 €	12,01 €



Termoventilatore
Ptc "Warmi"
Resistenza Ptc
Ardes S234AEU

Codice	Pz	Listino A	Listino B
S234AEU	1	23,24 €	25,79 €



Termoventilatore
Ceramico Ardes
AR4W02

Codice	Pz	Listino A	Listino B
AR4W02	1	42,80 €	47,51 €



TUDOR

Termoventilatore
Ceramico M07170

Codice	Pz	Listino A	Listino B
M07170	1	25,39 €	28,18 €



Ventilatore Da Parete Pala 40 Cm. 55 W
Vnco 70618



Codice	Riferimenti	Listino A	Listino B	Conf.	Box
70618	s/telec.	50,93 €	53,99 €	1	10
70619	C/telec.	64,85 €	68,74 €	1	10



Ventilatore da soffitto Vinco – design classico – 55W – diametro pale cm. 107 – 3 velocità – funzione estate/inverno – con lampada da 60W – predisposizione telecomando – colore bianco dettagli oro 70912



Codice	Riferimenti	Listino A	Listino B	Conf.	Box
70912		67,21 €	71,25 €	1	10



Ventilatore a piantana Vinco altezza regolabile fino a cm. 125 – 45W – diametro pale cm. 40 – oscillazione – colore bianco – base a crociera 70703E



Codice	Riferimenti	Listino A	Listino B	Conf.	Box
70703E		25,56 €	27,09 €	1	10



Ventilatore da soffitto Vinco – design classico – 55W – diametro pale cm. 107 – 3 velocità – funzione estate/inverno – con lampada da 60W – predisposizione telecomando – colore legno scuro pale bicolore legno scuro/crema 70919

Codice	Riferimenti	Listino A	Listino B	Conf.	Box
70919		61,73 €	65,43 €	1	10



Ventilatore da tavolo Vinco 40W – diametro pale cm. 30 – 3 velocità – oscillazione – colore bianco 70601



Codice	Riferimenti	Listino A	Listino B	Conf.	Box
70601	cm. 30	24,07 €	25,52 €	1	10
70602	cm. 40	29,50 €	31,27 €	1	10



Ventilatore 3 in 1 Vinco Piantana Tavolo Parete: piantana Vinco altezza regolabile fino a cm. 160 – 90W – diametro pale cm. 45 – 3 velocità – oscillazione – parte superiore con supporto per appoggio da tavolo o installazione fissa a parete – colore nero – base tonda 70718



Codice	Riferimenti	Listino A	Listino B	Conf.	Box
70718		48,29 €	51,19 €	1	10



Ventilatore A Piantana Con Umidificatore AR5M39



Codice	Riferimenti	Listino A	Listino B	Conf.	Box
AR5M39		127,88 €	135,55 €	1	10



variati – Raffrescatore con tecnologia A Ultrasuoni, 5 Pale Semi-Trasparenti Diam. 40 Cm, Griglia A Raggiera, Oscillazione Automatica, 3 Velocità, Pannello Di Controllo Digitale Touch, Indicatore Livello Acqua, Timer 7,5H E Telecomando. Umidificatore A



Codice	Riferimenti	Listino A	Listino B	Conf.	Box
AR5M41		161,61 €	171,31 €	1	10



Ventilatore A Piantana 120Cm 3 Pale Semitrasparenti, Motore 45W, Colore Bianco Con Dettagli Grigi TXWZ01



Codice	Riferimenti	Listino A	Listino B	Conf.	Box
TXWZ01		27,88 €	29,56 €	1	10



Ventilatore A Piantana 120Cm 5 Pale Semitrasparenti Blu 45W Colore Nero/Blu TZWZ02PLUS



Codice	Riferimenti	Listino A	Listino B	Conf.	Box
TZWZ02PLUS		31,76 €	33,67 €	1	10



Insetticida elettrico orizzontale Vinco da appoggio o sospensione – per interni o esterni – potenza lampade UV 2x10W – cassetto estraibile per pulizia – protegge aree fino a 60 mq. – colore grigio 20250



Codice	Riferimenti	Listino A	Listino B	Conf.	Box
20250		41,75 €	44,25 €	1	10



Insetticida elettrico orizzontale Vinco da appoggio o sospensione – per interni o esterni – potenza lampade UV 2x10W – cassetto estraibile per pulizia – protegge aree fino a 60 mq. – colore grigio 20260



Codice	Riferimenti	Listino A	Listino B	Conf.	Box
20260		48,71 €	51,63 €	1	10



Insetticida elettrico orizzontale Vinco da appoggio o sospensione – per interni o esterni – potenza lampade UV 2x6W – cassetto estraibile per pulizia – protegge aree fino a 30 mq. – colore grigio 20230



Codice	Riferimenti	Listino A	Listino B	Conf.	Box
20230	Arrivo	Arrivo	Arrivo	1	10



Insetticida elettrico orizzontale Vinco da appoggio o sospensione – per interni o esterni – potenza lampade UV 2x8W – cassetto estraibile per pulizia – protegge aree fino a 40 mq. – colore grigio 20240



Codice	Riferimenti	Listino A	Listino B	Conf.	Box
20240		37,43 €	39,68 €	1	10



Codice	Riferimenti	Listino A	Listino B	Off.	Box
		Arrivo	Arrivo	1	10

Codice	Riferimenti	Listino A	Listino B	Off.	Box
		Arrivo	Arrivo	1	10

Codice	Riferimenti	Listino A	Listino B	Off.	Box
		Arrivo	Arrivo	1	10

Codice	Riferimenti	Listino A	Listino B	Off.	Box
		Arrivo	Arrivo	1	10

Codice	Riferimenti	Listino A	Listino B	Off.	Box
		Arrivo	Arrivo	1	10

Codice	Riferimenti	Listino A	Listino B	Off.	Box
		Arrivo	Arrivo	1	10

Codice	Riferimenti	Listino A	Listino B	Off.	Box
		Arrivo	Arrivo	1	10

Codice	Riferimenti	Listino A	Listino B	Off.	Box
		Arrivo	Arrivo	1	10

Codice	Riferimenti	Listino A	Listino B	Off.	Box
		Arrivo	Arrivo	1	10

Codice	Riferimenti	Listino A	Listino B	Off.	Box
		Arrivo	Arrivo	1	10

Codice	Riferimenti	Listino A	Listino B	Off.	Box
		Arrivo	Arrivo	1	10

Codice	Riferimenti	Listino A	Listino B	Off.	Box
		Arrivo	Arrivo	1	10



compatibile con il supporto Plana 14613 da 2 - 3 - 4 - 7 posti

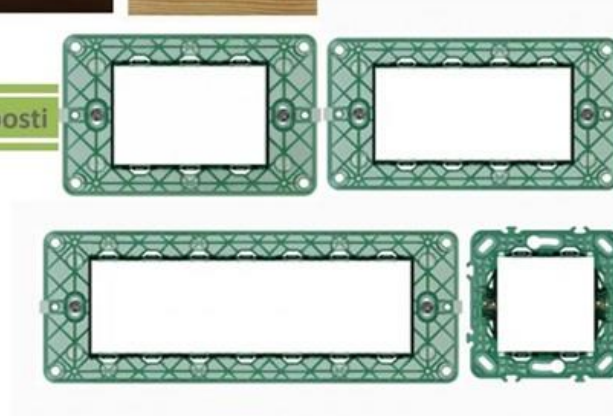



Interruttore unipolare 1p 16A 250VAC , comando basculante, con morsetti a vite.
 Sistema di cablaggio interruttore unipolare
 Funzionamento interruttore basculante / pulsante
 Numero di tasti a bilanciere 1
 Metodo di montaggio incasso a parete
 Materiale plastica
 Colore Bianco
 Con campo di testo / area di scrittura no
 Tensione nominale 250 VAC
 Corrente nominale 16 A

Codice	Cod. Ean	Listino A	Listino B	Conf.	Box
EV0401	8059692404766	2,53 €	2,81 €	1	10



Deviatore 1 posto 16A 250VAC , comando basculante, con morsetti a vite.
 Sistema di cablaggio deviatore
 Funzionamento interruttore basculante / pulsante
 Numero di tasti a bilanciere 1
 Metodo di montaggio incasso a parete
 Materiale plastica
 Colore Bianco
 Con campo di testo / area di scrittura NO
 Tensione nominale 250 VAC
 Corrente nominale 16 A

Codice	Cod. Ean	Listino A	Listino B	Conf.	Box
EV0801	8059692404797	3,04 €	3,37 €	1	10



Pulsante 1 Posto NO 10 A 250 VAC, comando basculante con morsetti a vite normalmente aperto
 Modello a tasto singolo
 Funzionamento pulsante
 Contatti 1 contatto (normalmente aperto)
 Numero di tasti a bilanciere 1
 Metodo di montaggio incasso a parete
 Materiale plastica
 Colore Bianco
 Con campo di testo / area di scrittura no
 Tensione nominale 250 VAC
 Corrente nominale 16 A

Codice	Cod. Ean	Listino A	Listino B	Conf.	Box
EV1001	8059692404810	3,04 €	3,37 €	1	10



PRESA TV DERIVATA MASCHIO
 Presa coassiale diretta, derivata, per impianti di antenna monoutenza anche telealimentati e centralizzati ed impianti via satellite monoutente e centralizzati con passaggio di corrente e di segnale per la selezione dei canali - morsetti di collegamento schermati con viti imperdibili ø 9,5 mm connettore maschio 1 modulo
 Modello Presa coassiale TV
 Metodo di Montaggio Incasso a parete
 Materiale plastica
 Colore Bianco

Codice	Cod. Ean	Listino A	Listino B	Conf.	Box
EV2250	8059692404957	Arrivo	Arrivo	1	10



Presse bivalente 2 poli + terra 16 ampere 250 vac interasse 19mm e 26mm alveoli schermati per spine 2 poli e 2 poli + terra da 10 e da 16 ampere.
 Modello con contatto di terra
 Numero di unità 1
 Materiale plastica
 Colore Bianco
 Corrente nominale 16A
 Tensione nominale 250VAC

Codice	Cod. Ean	Listino A	Listino B	Conf.	Box
EV20001	8059692404902	3,04 €	3,37 €	1	10



Interruttore bipolare 1p 16A 250VAC , comando basculante, con morsetti a vite.
 Sistema di cablaggio interruttore bipolare
 Funzionamento interruttore basculante / pulsante
 Numero di tasti a bilanciere 1
 Metodo di montaggio incasso a parete
 Materiale plastica
 Colore Bianco
 Con campo di testo / area di scrittura NO
 Tensione nominale 250 v
 Corrente nominale 16 a

Codice	Cod. Ean	Listino A	Listino B	Conf.	Box
EV0402	8059692404780	4,55 €	5,06 €	1	10



Invertitore 1 posto 16A 250VAC , comando basculante, con morsetti a vite.
 Sistema di cablaggio invertitore
 Funzionamento interruttore basculante / pulsante
 Numero di tasti a bilanciere 1
 Metodo di montaggio incasso a parete
 Materiale plastica
 Colore Bianco
 Con campo di testo / area di scrittura no
 Tensione nominale 250 VAC
 Corrente nominale 16 A

Codice	Cod. Ean	Listino A	Listino B	Conf.	Box
a	0	Arrivo	Arrivo	1	10



Suoneria 230 vac 5 va 75 db
 Modello Suoneria
 Tipo corrente AC
 Metodo di montaggio incasso a parete
 Materiale plastica
 Colore Bianco
 Tensione nominale 250VAC

Codice	Cod. Ean	Listino A	Listino B	Conf.	Box
a	0	Arrivo	Arrivo	1	10



Presse coassiale diretta tipo f impedenza 75 ohm.
 Modello Presa coassiale TV
 Metodo di Montaggio Incasso a parete
 Materiale plastica
 Colore Bianco

Codice	Cod. Ean	Listino A	Listino B	Conf.	Box
a	0	Arrivo	Arrivo	1	10



Presse telefono con connettore standard RJ11
 Modello con contatto di terra
 Numero di unità 1
 Materiale plastica
 Colore Bianco
 Corrente nominale 16A
 Tensione nominale 250VAC

Codice	Cod. Ean	Listino A	Listino B	Conf.	Box
a	0	Arrivo	Arrivo	1	10



Doppio pulsante 1 Polo * NO + 1 Polo NO 10
ampere 250 Volt
* no = normalmente aperto
Modello gruppo pulsanti
Funzionamento pulsante
Contatti 2 contatti (no)
Numero di tasti a bilanciere 2
Metodo di montaggio incasso a parete
Materiale plastica
Colore Bianco
Tensione nominale 250VAC
Corrente nominale 10A



Presse shuko 2P+T 16A 250 Va.c. - interasse 19mm e 26mm in configurazione bipasso - alveoli protetti; contatti laterali di terra per spine standard tedesco; adatta per: spine standard Italia 2P e 2P+T 10/16A, spine standard tedesco 2P+T 16A
Modello presa shuko
Contatti 2P + T
Metodo di montaggio incasso a parete
Materiale plastica
Colore Bianco
Tensione nominale 250VAC
Corrente nominale 16A

Codice	Cod. Ean	Listino A	Listino B	Conf.	Box
a	0	Arrivo	Arrivo	1	10

Codice	Cod. Ean	Listino A	Listino B	Conf.	Box
a	0	Arrivo	Arrivo	1	10

Presse USB ad una presa 2A 5V - 1 modulo
Modello USB
Funzionamento 5V
Metodo di montaggio incasso a parete
Materiale plastica
Colore Bianco
Tensione di ingresso 250VAC
Frequenza 50/60Hz



Connettore RJ45 per cavo UPT categoria 5e
Modello presa dati
Attacco RJ45 (UTP Cat.5E)
Metodo di montaggio incasso a parete
Materiale plastica
Colore Bianco



Codice	Cod. Ean	Listino A	Listino B	Conf.	Box
a	0	Arrivo	Arrivo	1	10

Codice	Cod. Ean	Listino A	Listino B	Conf.	Box
a	0	Arrivo	Arrivo	1	10

Presse USB a due prese 1A 5V - 1 modulo
Modello USB
Funzionamento 5V
Metodo di montaggio incasso a parete
Materiale plastica
Colore Bianco
Tensione di ingresso 250VAC
Frequenza 50/60Hz



Presse Tipo C
Modello Tipo C
Funzionamento 5V=2.4A
Metodo di montaggio incasso a parete
Materiale plastica
Colore Bianco
Tensione di ingresso 100-240V
Frequenza 50/60Hz



Codice	Cod. Ean	Listino A	Listino B	Conf.	Box
a	0	Arrivo	Arrivo	1	10

Codice	Cod. Ean	Listino A	Listino B	Conf.	Box
a	0	Arrivo	Arrivo	1	10

Presse USB-A + Tipo C
Modello USB+Tipo C
Funzionamento 5V=2.4A
Metodo di montaggio incasso a parete
Materiale plastica
Colore Bianco
Tensione di ingresso 100-240V
Frequenza 50/60Hz



FALSO POLO 1 POSTO (2PZ) EVO100



Codice	Cod. Ean	Listino A	Listino B	Conf.	Box
a	0	Arrivo	Arrivo	1	10

Codice	Cod. Ean	Listino A	Listino B	Conf.	Box
EVO100	8059692404643	1,39 €	1,55 €	1	10

Codice	Cod. Ean	Listino A	Listino B	Conf.	Box
a	0	Arrivo	Arrivo	1	10

Codice	Cod. Ean	Listino A	Listino B	Conf.	Box
a	0	Arrivo	Arrivo	1	10

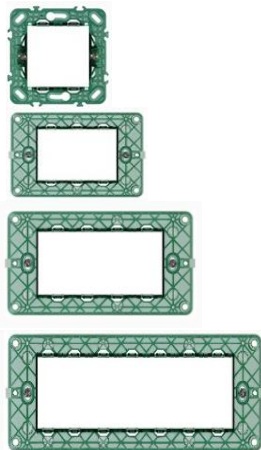

a
Articolo da Caricare

a
Articolo da Caricare

EV0203
SUPPORTO 3 POSTI EV0203

a
Articolo da Caricare

a
Articolo da Caricare

Codice	Cod. Ean	Listino A	Listino B	Conf.	Box
a	0	Arrivo	Arrivo	1	10
a	0	Arrivo	Arrivo	1	10
EV0203	8059692404667	1,16 €	1,29 €	1	10
a	0	Arrivo	Arrivo	1	10
a	0	Arrivo	Arrivo	1	10



a
Articolo da Caricare

a
Articolo da Caricare

a
Articolo da Caricare

a
Articolo da Caricare

a
Articolo da Caricare

a
Articolo da Caricare

Codice	Cod. Ean	Listino A	Listino B	Conf.	Box
a	0	Arrivo	Arrivo	1	10
a	0	Arrivo	Arrivo	1	10
a	0	Arrivo	Arrivo	1	10
a	0	Arrivo	Arrivo	1	10
a	0	Arrivo	Arrivo	1	10



MT3503
CASSETTA MONTAGGIO
ESTERNO 3P MT3503

0

0

Codice	Cod. Ean	Listino A	Listino B	Conf.	Box
MT3503	8059692400720	1,86 €	2,06 €	1	10
		Arrivo	Arrivo	1	10
		Arrivo	Arrivo	1	10



V71303
Scatola incasso rettangolare 3M
azzurro

V71304
Scatola incasso rettangolare 4M
azzurro

V71305
Scatola incasso rettangolare 5M
azzurro

V71306
Scatola incasso rettangolare 6-7M
azzurro

V71703
Scatola incasso 3M p/leggere azzurro

Codice	Cod. Ean	Listino A	Listino B	Conf.	Box
V71303	#N/D	Arrivo	Arrivo	1	10
V71304	#N/D	Arrivo	Arrivo	1	10
V71305	#N/D	Arrivo	Arrivo	1	10
V71306	#N/D	Arrivo	Arrivo	1	10
V71703	#N/D	Arrivo	Arrivo	1	10



a
Articolo da Caricare

a
Articolo da Caricare

a
Articolo da Caricare

a
Articolo da Caricare

a
Articolo da Caricare

a
Articolo da Caricare

Codice	Cod. Ean	Listino A	Listino B	Conf.	Box
a	0	Arrivo	Arrivo	1	10
a	0	Arrivo	Arrivo	1	10
a	0	Arrivo	Arrivo	1	10
a	0	Arrivo	Arrivo	1	10
a	0	Arrivo	Arrivo	1	10
a	0	Arrivo	Arrivo	1	10



0

0

EV2703
CUSTODIA INCASSO 3 POSTI
IP55 EV2703

Codice	Cod. Ean	Listino A	Listino B	Conf.	Box
EV2703	8059692409303	5,81 €	6,45 €	1	10
		Arrivo	Arrivo	1	10
		Arrivo	Arrivo	1	10



Cavo elettrico
classe CCa-s 3.D1.A3 is450/750



Cavo solare filo fotovoltaico
H1Z2Z2-K 1500V 12/10 AWG 4
mm2 6 mm2 cavo rame stagnato
rivestimento XLPE per pannelli
fotovoltaici certificazione TUV

Cambia la Lettera finale per il colore di riferimento

Cambia la Lettera finale per il colore di riferimento

Azzurro	Nero	Marrone	Grigio	Rosso
A	N	M	G	R
Giallo/Verde GV				

Nero	Rosso
Nem	Rom

Codice	Riferimenti	Listino A	Listino B	Conf.	Box
CU1,5A	Azzurro	Vedi foglio commissione excel		1	100
CU2,5A	Azzurro	Vedi foglio commissione excel		1	100
CU4A	Azzurro	Vedi foglio commissione excel		1	100
CU6A	Azzurro	Vedi foglio commissione excel		1	100
CU10A	Azzurro	Vedi foglio commissione excel		1	100

Codice	Riferimenti	Listino A	Listino B	Conf.	Box
	2,5 mm Nero	Arrivo	Arrivo	1	500
	4 mm Nero	Arrivo	Arrivo	1	500
H1Z2Z2H6NEM	6 mm Nero	1,72 €	1,91 €	1	500
	10 mm Nero	Arrivo	Arrivo	1	500



DIAMETRO
16 - 20 - 25 - 32

Cambia la Lettera finale per il colore di riferimento

Cambia la Lettera finale per il colore di riferimento

Azzurro	Nero	Marrone	Grigio	Rosso
A	N	M	G	R

Azzurro	Nero	Marrone	Grigio	Rosso
A	N	M	G	R

Codice	Riferimenti	Listino A	Listino B	Conf.	Box
		Arrivo	Arrivo	1	500
		Arrivo	Arrivo	1	500
		Arrivo	Arrivo	1	500
		Arrivo	Arrivo	1	500

Codice	Riferimenti	Listino A	Listino B	Conf.	Box
		Arrivo	Arrivo	1	500
		Arrivo	Arrivo	1	500
		Arrivo	Arrivo	1	500
		Arrivo	Arrivo	1	500

Codice	Cod. Ean	Listino A	Listino B	Conf.	Box
		Arrivo	Arrivo	1	10

Codice	Cod. Ean	Listino A	Listino B	Conf.	Box
		Arrivo	Arrivo	1	10

Codice	Cod. Ean	Listino A	Listino B	Conf.	Box
		Arrivo	Arrivo	1	10

Codice	Cod. Ean	Listino A	Listino B	Conf.	Box
		Arrivo	Arrivo	1	10

XSL1003N Spina Dritta 2Pt 16A 250 V Nera
XSL1003N



Spina Mobile Calpestabile 2P+t (SL1003)
16A 250V Bianca XSL1003



Codice	Cod. Ean	Listino A	Listino B	Conf.	Box
XSL1003N	8033695339522	1,24 €	1,38 €	1	10
XSL1003	0	1,29 €	1,43 €	1	10

8042 adattatore spina 2 presa bipasso
1 presa schuko 8042



adattatore spina 3 presa bipasso 8026



Codice	Cod. Ean	Listino A	Listino B	Conf.	Box
8042	8050059008443	1,64 €	1,83 €	1	10
8026	8050059015380	1,64 €	1,83 €	1	10

0



0



Codice	Cod. Ean	Listino A	Listino B	Conf.	Box
		Arrivo	Arrivo	1	10
		Arrivo	Arrivo	1	10

0



0



Codice	Cod. Ean	Listino A	Listino B	Conf.	Box
		Arrivo	Arrivo	1	10
		Arrivo	Arrivo	1	10

0



0



Codice	Cod. Ean	Listino A	Listino B	Conf.	Box
		Arrivo	Arrivo	1	10
		Arrivo	Arrivo	1	10

202402 Multipresa 4 pos. 10/16a
.bipasso / schuko con
interruttore luminoso 202402



Multipresa 7 pos. 10/16a 202305
.bipasso / schuko con
interruttore luminoso 202305



Codice	Cod. Ean	Listino A	Listino B	Conf.	Box
202402	8033695333674	12,02 €	13,34 €	1	10
202305	8033695332592	12,65 €	14,04 €	1	10

XSL1083N Articolo da Caricare



Presca Mobile Calpestabile 22Pt XSL1083
10/16A 250V Bianca XSL1083



Codice	Cod. Ean	Listino A	Listino B	Conf.	Box
XSL1083N	#N/D	Arrivo	Arrivo	1	10
XSL1083	8033695332998	1,52 €	1,69 €	1	10

0



0



Codice	Cod. Ean	Listino A	Listino B	Conf.	Box
		Arrivo	Arrivo	1	10
		Arrivo	Arrivo	1	10

0



0



Codice	Cod. Ean	Listino A	Listino B	Conf.	Box
		Arrivo	Arrivo	1	10
		Arrivo	Arrivo	1	10

0



0



Codice	Cod. Ean	Listino A	Listino B	Conf.	Box
		Arrivo	Arrivo	1	10
		Arrivo	Arrivo	1	10

0



0



Codice	Cod. Ean	Listino A	Listino B	Conf.	Box
		Arrivo	Arrivo	1	10
		Arrivo	Arrivo	1	10

0



0



Codice	Cod. Ean	Listino A	Listino B	Conf.	Box
		Arrivo	Arrivo	1	10
		Arrivo	Arrivo	1	10

Nota Bene i prezzi di questo Catalogo sono puramente indicativi, potete trovare conferma dei prezzi dal foglio commissione in excel scaricabile dal nostro sito, ove potete trovare anche le giacenze e merce in arrivo indicative della settimana, oppure dalla nostra piattaforma On Line, o ricevete conferma ordine se ordine con modalità diverse.

- 1) La vendita e la spedizione vengono effettuate alle condizioni qui di seguito riportate, I prezzi di listino o le promo sono convalidati mediante commissione in excel a vostra disposizione, e lo sconto applicato secondo le indicazioni del vostro referente commerciale la conferma ordine se da voi richiesta, si intenderà accettata automaticamente, tranne indicazioni diverse da parte del committente immediatamente.
- 2) Tutti gli ordini e relative modalità di pagamento e di trasporto si intendono accettati solo dopo nostra approvazione, nel caso di non approvazione per modalità non accettabili da parte nostra vi sarà inviata conferma o vi sarà comunicato dal vostro referente commerciale le difformità nell'ordine a noi ricevuto
- 3) La merce viaggia a rischio e pericolo del committente anche se spedita con contributo minimo addebitato in fattura. La ditta fornitrice non risponde di eventuali ammanchi o avarie avvenute durante il trasporto o successiva alla consegna. I reclami in tal senso dovranno essere presentati dal destinatario al trasportatore prima e durante il ritiro della merce, con relativa lamentela sottoscritta nel documento di ricevimento e sottoscritto dall'autista responsabile della consegna.
Se la merce viaggia con corriere nazionale il committente avrà l'obbligo di spuntarsi la merce davanti al corriere e scrivere oltre la riserva generica la natura dell'anomalia e sottoscriverla dall'autista del corriere, ed inviare la copia alla nostra amministrazione entro 2 giorni della consegna, via Email: info@csrconi.com in modo da rivalerci con il corriere o assicurazione qual'ora da voi richiesta, non ricevendo i documenti nei tempi dovuti, l'azienda si esonera a riborsi totali o parziali se impossibilitata a recuperarli dal trasportatore o assicurazione (se da voi richiesta)
- 4) I termini di consegna convenuti si intendono puramente indicativi sette giorni lavorativi dall'ordine o conferma ordine se condizioni o modalità diverse dall'ordine da noi ricevuto.
Eventuali ritardi non daranno diritto al Committente a nessun indennizzo o compenso.
L'annullamento di un ordine per eventuali ritardi o non accettazione della conferma d'ordine da noi inviata solo per modalità diverse o se da voi richiesta dovrà pervenirci immediatamente, o si intenderà confermata tacitamente.
Modalità di Pagamento, di Imballo, di trasporto, e spese varie, sarà eventualmente concesso a nostra discrezione e comunque mai dopo la consegna, se non previo conferma d'ordine se diverse dalle nostre indicazioni.
- 5) La merce consegnata rimane di riservato dominio della fornitrice fino all'avvenuto pagamento della stessa. L'eventuale ritardo di pagamento ci autorizza al ritiro della merce anche se già fatturata, con relativa nota di credito, con addebito delle spese per il ritiro della merce in questione.
- 6) I pagamenti debbono essere effettuati esclusivamente nelle forme convenute. In caso di ritardo pagamento rispetto alle scadenze pattuite, decorrerà senza bisogno di avviso o messa in mora, gli interessi per ritardo pagamento (secondo le indicazioni delle spese da noi sostenute da parte nostra). Il ritardo pagamento di precedenti forniture ci autorizza ad annullare ogni ordine in corso.
- 7) Non si accettano resi se non da noi autorizzati con modulo da voi debitamente compilato e da noi accettato. La maggiorparte degli articoli trovano assistenza delle Aziende Madri nel territorio nazionale, a cui il committente dovrà rivolgersi anche per anomalie immediate.
- 8) Eventuali contestazioni non ci conferiscono al cliente diritto al differimento o sostituzione dei pagamenti alla data convenuta pena paragrafo 6) addebito interessi per ritardo pagamento.
- 9) Per ogni controversia sarà competente il Foro Di PALERMO
- 10) Scarica il Modulo reso

Scarica Modulo Di Reso



PROFESSIONALITA' E QUALITA'



EVOKlima™

TECNOLOGIA - BENESSERE - RISPETTO PER L'AMBIENTE

WWW.EVOKLIMA.IT

PRESENTE NELLA PIATTAFORMA



www.edrcsr.it

Tutto per la casa dalla a alla z

La Piattaforma

Rivolta

ai rivenditori

e professionisti del Settore

Gruppo **C. S. R. s. r. l.** unipersonale

Deposito Zona Industriale Asi contrada San Benedetto Aragona (AG)

Email: edrcsr@gmail.com Info@evoklima.it Tel. 09221801565-0922192221

Responsabile magazzino agrigento Alessio Conti +39 328 202 6997